

haupa®

...together even stronger

BRINKO®



HAUPA | Quality tools and connection technology for the electrical trade and the electrical industry

Tradition and innovative prowess for more than 60 years

In 1961, Hans-Udo Paas founded HAUPA in Remscheid, the centre of the German tool industry. The company name was derived from the owner's name. Hans-Udo Paas became HAUPA. More than 60 years later, our medium-sized second-generation family business is still selling tools and cable connection equipment to the electrical trade and industry through electrical wholesalers. Our range now contains more than 7,000 products that are available in more than 50 countries across the world. Right from the outset, we have grown constantly. What is it that drives us? Our desire to develop highly precise products that offer users added value.

Our experience, tradition, innovative prowess and reliability make us your partner in the tools and cable connection technology fields. After we took over BRINKO in 2020, we were able to expand our portfolio by 1,000 items in the plumbing & HVAC tool field. This opens up completely new perspectives throughout the sanitary and electrical wholesaling field. Both companies, HAUPA and BRINKO, have a traditional and family-run background. BRINKO has been deeply rooted in Remscheid since 1860.



Jens-Ole Paas
CEO

This HAUPA general catalogue contains our new sanitary program for the first time – a milestone for us and, hopefully, for you, too. We look forward to showing you the advantages of our products, and hope you enjoy browsing through the catalogue.

Jens-Ole Paas and the entire HAUPA Team

Quality

HAUPA has been certified according to DIN EN ISO 9000 since 1996 (2003 DIN EN ISO 9001).

In order to incorporate a true quality standard the quality management department of HAUPA decided at a very early stage to apply for ISO 9000 certification, which controls and covers the complete internal working and monitoring procedures.

From goods receipt to dispatch – all working processes are carried out according to defined procedures.

All HAUPA employees receive regular training in order to comply with these standards and to encourage them to actively suggest ways of improving the processes. Special, so-called QMB inspectors analyse modified structures and integrate these into the defined standards. Independent auditors carry out audits at regular intervals to ensure compliance.



DIN EN ISO 9001:2015 - Certificate



German



English

Membership



HAUPA Productcertification



VDE GS



1000V IEC 60900



RoHS



EAC



UL



Brunel

Around the cable

Page 5 – 104



Cable connection technology

Page 105 – 203



Working under tension

Page 204 – 258

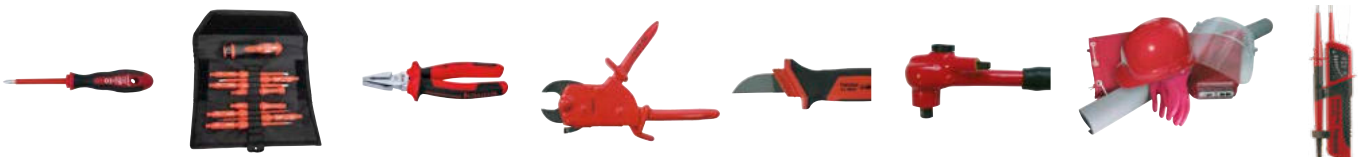

Standard program

Page 259 – 424



Plumbing program

Page 425 – 573



Legend

Page 574

Index

Page 575 – 596

Addresses



Page 597 – 601

Cutting



External Ø of wires and cables (average)

No. of wires Cross-section in mm ²	External-Ø NYM mm	External-Ø NYY (ca.) mm	External-Ø NYCY (ca.) mm	External-Ø H05RR-F (ca.) mm	External-Ø H07RN-F (ca.) mm
2 x 1,5	8,4 - 8,9	11	12	10,5	11,5
2 x 2,5	9,6 - 11	13	13	12,5	13,5
2 x 4	11 - 12,5	14	15	11	12,5
2 x 6	12 - 13,5	15	16	13	14,5
2 x 10	15 - 17	17	17,5	-	16
2 x 16	17 - 20	19	20	-	20
2 x 25	21 - 24	23	-	-	25,5
2 x 35	23,5 - 27,5	-	-	-	29
3 x 1,5	8,8 - 10,5	12	13	-	-
3 x 2,5	10 - 11,5	13	14	-	-
3 x 4	11,5 - 13	15	15	-	-
3 x 6	12 - 15	16	17	-	-
3 x 10	16 - 18	19	18,5	-	-
3 x 16	18,5 - 22	20	20,5	-	-
3 x 25	22,5 - 26	24	26,5	-	-
3 x 35	25 - 29,5	23	28	-	-
3 x 35/16	-	26	25	-	-
3 x 50/25	-	30	32	-	-
3 x 70/35	-	31	32	-	-
3 x 95/50	-	36	37	-	-
3 x 120/70	-	39	39	-	-
3 x 150/70	-	43	43	-	-
4 x 1,5	9,5 - 11	13	14	12,5	13,5
4 x 2,5	11 - 12,5	14	15	14	15,5
4 x 4	12,5 - 14,5	16	16	-	18
4 x 6	14,5 - 16,5	17	18	-	22
4 x 10	17 - 19,5	19	20,5	-	28
4 x 16	20,5 - 23,5	22	24	-	32
4 x 25	25 - 28,5	27	29	-	37
4 x 35	27,5 - 32	26	31	-	42
4 x 50	-	35	34	-	48
4 x 70	-	40	37	-	54
4 x 95	-	45	42	-	60
4 x 120	-	50	47	-	-
5 x 1,5	9,9 - 12	13	15	13,5	15
5 x 2,5	11,5 - 13,5	14	17	15,5	17
5 x 4	14 - 16,5	16	18	-	19
5 x 6	15,5 - 18	18	20	-	24
5 x 10	18,5 - 21,5	21	-	-	30
5 x 16	22,5 - 26	24	-	35	-
5 x 25	27,5 - 31,5	-	-	-	-
5 x 35	30,5 - 35,5	-	-	-	-

Cutting diameters of cable cutters Profi Line	art.	200111	200112	200113	200177	200114	200116	200115	200119	200179	200124	200126	200131	200151	200089	200183	200199
		Ø page 9	page 9	page 9	page 10	page 10	page 10	page 10	page 11	page 11	page 11	page 13	page 13	page 13	page 13	page 9	page 9
	Cu/Al	Cu/Al	Cu/Al	Cu/Al	Cu/Al	Cu/Al	Cu/Al	Cu/Al	Cu/Al	Cu/Al	Cu/Al	Cu/Al	Cu/Al	Cu/Al	Cu/Al	Cu/Al	Cu/Al
	185 mm ²	400 mm ²	240 mm ²	300 mm ²	400 mm ²	50 mm ²	1000 mm ²	1400 mm ²	120 mm ²	185 mm ²	240 mm ²	550 mm ²	185 mm ²	400 mm ²	SWA		
	34 mm Ø	52 mm Ø	35 mm Ø	45 mm Ø	52 mm Ø	62 mm Ø	80 mm Ø	100 mm Ø	25 mm Ø	34 mm Ø	35 mm Ø	55 mm Ø	32 mm Ø	52 mm Ø	45 mm Ø		
	Cu/Al	Cu/Al	Cu/Al	Cu/Al	Cu/Al	Cu/Al	Cu/Al	Cu/Al	Cu/Al	Cu/Al	Cu/Al	Cu/Al	Cu/Al	Cu/Al	Cu/Al	Cu/Al	Cu/Al
	240 mm ²	400 mm ²	240 mm ²	240 mm ²	480 mm ²	750 mm ²	1000 mm ²	1400 mm ²	120 mm ²	185 mm ²	240 mm ²	550 mm ²	185 mm ²	240 mm ²	45 mm Ø		
	34 mm Ø	52 mm Ø	35 mm Ø	45 mm Ø	52 mm Ø	62 mm Ø	80 mm Ø	100 mm Ø	25 mm Ø	34 mm Ø	35 mm Ø	55 mm Ø	32 mm Ø	52 mm Ø			
	Cu/Al	Cu/Al	Cu/Al	Cu/Al	Cu/Al	Cu/Al	Cu/Al	Cu/Al	Cu/Al	Cu/Al	Cu/Al	Cu/Al	Cu/Al	Cu/Al	Cu/Al	Cu/Al	Cu/Al
	240 mm ²	450 mm ²	300 mm ²	300 mm ²	500 mm ²	300 mm ²	750 mm ²	1000 mm ²	1400 mm ²	120 mm ²	240 mm ²	300 mm ²	550 mm ²	240 mm ²	450 mm ²		
	34 mm Ø	52 mm Ø	35 mm Ø	45 mm Ø	52 mm Ø	75 mm Ø	62 mm Ø	80 mm Ø	100 mm Ø	25 mm Ø	34 mm Ø	35 mm Ø	55 mm Ø	32 mm Ø	52 mm Ø		



PVC pipe cutters

PVC pipe cutter

for PVC pipes and all materials made from plastics and rubber, exchangeable blade, knife made from tool steel hardened in oil.

- little effort through special cutting geometry
- optimal transmission
- effortless work through ergonomically shaped handle
- incremental knife feed



Art. no.	∅	kg	PU
200214	35	0,235	1
200215	spare blades	0,040	1

PVC pipe cutter

for PVC pipes and all materials made from plastics and rubber, exchangeable blade, knife made from tool steel hardened in oil, retractable by the press of a button.

- little effort through special cutting geometry
- optimal transmission
- effortless work through ergonomically shaped handle
- incremental knife feed



Art. no.	∅	kg	PU
200216	42	0,270	1
200217	spare blades	0,055	1

PVC pipe cutter (with ratchet)

for PVC pipes and all materials made from plastics and rubber, exchangeable blade, knife made from tool steel hardened in oil, retractable by the press of a button.

- little effort through special cutting geometry
- optimal transmission
- effortless work through ergonomically shaped handle
- incremental knife feed
- suitable for wiring ducts



Art. no.	∅	kg	PU
200218	0 - 63	0,270	1
200219	replacement blade	0,055	1

Cable cutters

Kevlar cutter

to cut Kevlar fibre on optical fibre cables. Precision cut with cogs prevents the fibres from slipping and ensures a clean cut.

- Micro-meshing
- riveted joint
- specially coated blade



Art. no.	TL	kg	PU
200153	160	0,085	1

Cable scissors

Allround soft-grip scissors

The new allround Soft - Grip scissors with its relatively short blades and special handles are designed to fulfil the needs of the professional electrical installers. The impressive cutting performance and the tough construction make this new scissors a special tool.

- ergonomic design (2 component)
- slipping free handle - Soft - Grip
- high cutting performance by low cutting force
- precision toothing
- cable stripping device • stainless

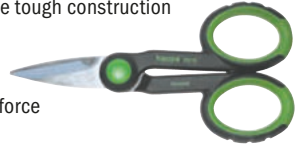

Art. no.	TL	mm ²	kg	PU
200155 *	140	25	0,086	1

Allround soft-grip scissors

The new allround Soft - Grip scissors with its relatively short blades and special handles are designed to fulfil the needs of the professional electrical installers. The impressive cutting performance and the tough construction make this new scissors a special tool.

- ergonomic design (2 component)
- slipping free handle - Soft - Grip
- high cutting performance by low cutting force
- precision toothing
- cable stripping device • stainless



Art. no.	TL	mm ²	kg	PU
200185 *	150	50	0,083	1

Combination scissors

stainless special steel, shock-proof plastic handles, one cutting edge slightly serrated, for cutting of cable, thin plate, wire, leather, cardboard, plastic, Al, Ms and Cu foils.

- opening spring and locking blade
- jam protection
- adjustable screw joint



Art. no.	TL	∅	kg	PU
200072	190	10	0,110	1

Our 1000 V pliers can be found on page 222.

haupa®

... convincing solutions

Cable cutter

Cable cutter

- for cutting copper/aluminium cables, fine wire, multiple-core and solid copper
- chrome vanadium steel, dip-insulated handles
- insulating function in upper head area
- cable measuring function thanks to the 180 degree crossover of the legs
- not for solid conductors
- data, telephone and control cable, maximum Ø 8 mm
- Cu single wire, maximum 16 mm²
- Cu fine wire, maximum 16 mm²
- Cu multi-wire, maximum 16 mm²
- Al single wire, maximum 16 mm²
- Al multi-wire, maximum Ø 8 mm = 16 mm²



Art. no.	TL	Ø	mm ²	kg	PU
201085 *	160	8	16	0,177	1

Cable cutter

- for cutting copper/aluminium cables, fine wire, multiple-core and solid copper
- chrome vanadium steel, dip-insulated handles
- insulating function in upper head area
- cable measuring function thanks to the 180 degree crossover of the legs
- not for solid conductors
- data, telephone and control cable, maximum Ø 12 mm
- Cu single wire, maximum 16 mm²
- Cu fine wire, maximum 35 mm²
- Cu multi-wire, maximum 25 mm²
- Al single wire, maximum 25 mm²
- Al multi-wire, maximum Ø 8 mm = 25 mm²



Art. no.	TL	Ø	mm ²	kg	PU
201087	200	12	35	0,289	1

Cable cutter

- for cutting copper/aluminium cables, fine wire, multiple-core and solid copper
- chrome vanadium steel, plug-on handles
- insulating function in upper head area
- cable measuring function thanks to the 180 degree crossover of the legs
- not for solid conductors
- data, telephone and control cable, maximum Ø 8 mm
- Cu single wire, maximum 16 mm²
- Cu fine wire, maximum 16 mm²
- Cu multi-wire, maximum 16 mm²
- Al single wire, maximum 16 mm²
- Al multi-wire, maximum Ø 8 mm = 16 mm²



Art. no.	TL	Ø	mm ²	kg	PU
201086	180	8	16	0,216	1

Cable cutter

- for cutting copper/aluminium cables, fine wire, multiple-core and solid copper
- chrome vanadium steel, plug-on handles
- insulating function in upper head area
- cable measuring function thanks to the 180 degree crossover of the legs
- not for solid conductors
- data, telephone and control cable, maximum Ø 12 mm)
- Cu single wire, maximum 16 mm²
- Cu fine wire, maximum 35 mm²
- Cu multi-wire, maximum 25 mm²
- Al single wire, maximum 25 mm²
- Al multi-wire, maximum Ø 8 mm = 25 mm²



Art. no.	TL	Ø	mm ²	kg	PU
201088	240	12	35	0,361	1

Cable cutters with spring joint

- for cutting Cu/Al cables, fine and multi-wiring
- not suitable for steel wire and wire rope
- chrome vanadium steel
- self-opening joint spring
- enormous cutting power with reduced force expenditure
- not for solid conductors



Art. no.	TL	Ø	mm ²	kg	PU
200086 *	170	10	25	0,266	1
200088 *	230	15	70	0,475	1

Cable cutter

- for cutting Cu/Al cables.
- data, telephone and control cable, maximum Ø 25 mm
 - Cu single wire, maximum 16 mm²
 - Cu fine wire, maximum 70 mm²
 - Cu multi-wire, maximum 50 mm²



Art. no.	TL	Ø	mm ²	kg	PU
200105	215	20	70	0,281	1

	single wire		wire rope
	multi-wire		armoured steel cable (SWA)
	sector-shaped		ACSR
	fine wire		BOLT
	communication/ data		solid steel
			solid Cu

One-hand cable cutters

Cable cutter with a snap

- one-hand cable cutter for fine wire cables only
- low force required
- laser-cut components
- CNC-ground cutting
- inductively hardened blades
- adjustable screw joint
- Cu fine wire cable, maximum \varnothing 16.9 mm = 70 mm²



Art. no.	TL	Ø	mm ²	kg	PU
201002	180	16,9	70	0,241	1

Cable cutter with a snap

- one-handed cable cutters for fine wire cables only
- two-stage adjustment mechanism (patent)
- low force required
- laser-cut components
- CNC-ground cutting
- inductively hardened blades
- adjustable screw joint
- telephone cable maximum \varnothing 26.1 mm
- Cu fine wire cable, maximum \varnothing 18.9 mm = 120 mm²



Art. no.	TL	Ø	mm ²	kg	PU
201000	230	18,9	120	0,514	1

Cable cutters

Cable cutter

- for cutting Cu/Al cables, fine and multi-wiring
- not suitable for steel wire and wire rope
- low force required thanks to best blade geometry and translation ratios
- vanadium electro-steel, forged, oil-hardened
- aluminium legs
- hardened blades with precision grinding
- adjustable screw joint



Art. no.	TL	Ø	mm ²	kg	PU
200087	500	27	150	1,026	1

Cable cutters

- for cutting Cu/Al cables, fine and multi-wiring
- surface-ground, rust-protected blades made from annealed chrome vanadium steel
- Impact-proof coated, hardened handle tubes, sickle-shaped rounded blades
- highest stability with the lowest own weight

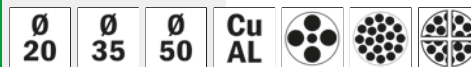

Art. no.	TL	Ø	mm ²	kg	PU
200073	300	20	120	0,620	1
200073/MK			cutting head	0,190	1
200095	530	35	185	1,652	1
200095/MK			cutting head	0,610	1
200099	780	50	400	3,380	1
200099/MK			cutting head	1,202	1

Our 1000 V pliers can be found on page 222.

haupa®

... convincing solutions

Wire Cutter (ACSR)

Cable cutters „Super light”

- for cutting Cu and Al cables, fine and multi-wiring
- not suitable for steel wire and wire rope
- extremely light thanks to full aluminium handles
- dual lever ensures easy cutting
- hardened blades with precision grinding
- adjustable screw joint
- blade head in chrome vanadium steel, forged and oil-hardened

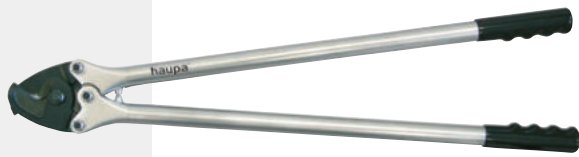

Art. no.	TL	Ø	mm ²	kg	PU
200197	700	24	120	1,839	1

Cable cutter

- for cutting Cu and Al cables, fine and multi-wiring
- not suitable for steel wire and wire rope
- dual lever ensures easy cutting
- hardened blades with precision grinding
- adjustable screw joint
- blade head in chrome vanadium steel, forged and oil-hardened



Art. no.	TL	Ø	mm ²	kg	PU
200100	980	40	400	3,920	1
200104			cutting head	0,606	1

Bolt cutters

Bolt cutter

- cuts soft and hard wires, piano wire
- cuts bolts, nails, rivets etc. up to Ø 3.6 mm
- particularly high cutting performance with low force required thanks to extremely effective joint construction
- blades are also inductively hardened, blade hardness approximately 64 HRC
- chrome vanadium high-performance steel, forged, oil-hardened



Art. no.	TL	Ø	kg	PU
200170	200	3,6	0,111	1

Wire cutter

- Cu and Al cables 10 mm²
- ACSR Ø 6 mm
- solid Ø 4 mm
- also suitable for cable and round steel
- suitable for separating open wires with pull relief wire
- with opening spring and latch
- special cutting geometry prevents the wire from unsplicing

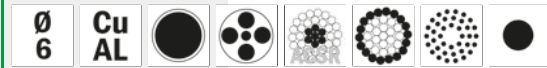

Art. no.	TL	Ø	mm ²	kg	PU
200173	180	6	10	0,306	1

Wire cutter

- Cu and Al cable 95 mm²
- ACSR Ø 10 mm
- solid Ø 6 mm
- also suitable for cables and round bars
- special cutting geometry prevents the wire from unsplicing
- suitable for separating open wires with pull relief wire
- exchangeable milling head

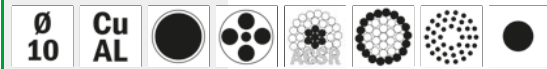
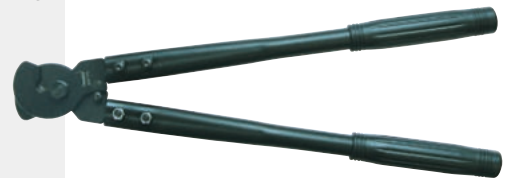

Art. no.	TL	Ø	mm ²	kg	PU
200175	180	10	95	0,752	1

Wire cutter

- Cu and Al cable 150 mm²
- ACSR Ø 14 mm
- solid Ø 9 mm
- also suitable for cables and round bars
- special cutting geometry prevents the wire from unsplicing
- suitable for separating open wires with pull relief wire
- angled cutting tip allows you to cut individual cables
- optimal transmission for excellent cutting performance
- exchangeable milling head

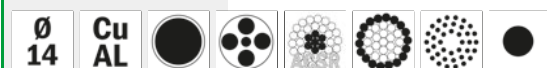

Art. no.	TL	Ø	mm ²	kg	PU
200181	700	14	150	2,390	1

Cable cutters

Hand cable cutter

ratchet action type, with spare blade, for copper and alu cable



Art. no.		mm ²	Ø
200089			
Cutting range:	Cu/Al wire multi wiring	185	32
	Cu/Al wire sector format	185	32
	Cu wire fine wiring	240	32
	Cu wire fine wiring or telecommunication cable		32
Length:			230
Weight:			0,615

Hand cable cutter

ratchet action type, with spare blade, for copper and alu cable



Art. no.		mm ²	Ø
200183			
Cutting range:	Cu/Al wire multi wiring	400	52
	Cu/Al wire sector format	400	52
	Cu wire fine wiring	450	52
	Cu wire fine wiring or telecommunication cable		52
Length:			280
Weight:			0,914

Ratchet two handed cable cutter „SCAR45“ for SWA cable

Cutting capacity: Steel reinforced Cu-Al cables up to Ø 45 mm maximum



Art. no.		mm ²	Ø
200199			
Cutting range:	Steel reinforced Cu-Al cables	300	45
Length:			430
Weight:			1,700

INFO

Cable cutters 200111, 200112

Precise cut!

The blade joints (screw connection on rotation blade) are adjusted to 0.05 mm!

Durable and strong

Serrations on the blade and the transport handle are milled! The contact pressure is thus lower than for cast teeth.

- One-handed cable cutter
- Lever joint bolts, thickness 6.5 mm
- 16 mm full material, milled knee lever

Cable cutter

Handy one-hand device with smooth-running and robust drive technology up to 34 mm Ø, all moveable parts made from hardened steel



Art. no.		mm ²	Ø
200111			
Cutting range:	Cu/Al wire multi wiring	185	34
	Cu/Al wire sector format	240	34
	Cu wire fine wiring	240	34
	Cu wire fine wiring or telecommunication cable		34
Length:			250
Weight:			0,790

Cable cutter

Handy one- and two-hand tool with smooth-running and robust drive technology up to 52 mm Ø, all moving parts made from hardened steel



Art. no.		mm ²	Ø
200112			
Cutting range:	Cu/Al wire multi wiring	400	52
	Cu/Al wire sector format	400	52
	Cu wire fine wiring	450	52
	Cu wire fine wiring or telecommunication cable		52
Length:			320
Weight:			1,122

haupa[®]

... convincing solutions

Cable cutters with eccentric drive

INFO

Cable cutters

200113, 200177, 200114, 200116:

- One-hand cable cutters
- Dual needle-bearing offset lever 14 mm
- Particularly easy to move, thanks to reduction of friction on joint
- Considerable reduction of manual force
- Lever joint bolts, thickness 8 mm
- For the toughest of usage conditions
- Locking with a locking shaft
- Accidental opening of handles in tool case is prevented
- Transport handle play is fixed

Cable cutter

High leverage, perfected cutting force performance, particularly smooth-running cable cutter with needle bearing eccentric drive up to 35 mm Ø. Extremely durable tool



Art. no.

Art. no.		mm ²	Ø
200113			
Cutting range:	Cu/Al wire multi wiring	240	35
	Cu/Al wire sector format	240	35
	Cu wire fine wiring	300	35
	Cu wire fine wiring or telecommunication cable		35
Length:			250
Weight:			0,976

Cable cutter

High leverage, perfected cutting force performance, particularly smooth-running cable cutter with needle bearing eccentric drive for everyday use up to 45 mm Ø. Extremely durable tool



Art. no.

Art. no.		mm ²	Ø
200177			
Cutting range:	Cu/Al wire multi wiring	300	45
	Cu/Al wire sector format	240	45
	Cu wire fine wiring	300	45
	Cu wire fine wiring or telecommunication cable		45
Length:			260
Weight:			0,900

Cable cutter

High leverage, perfected cutting force performance, particularly smooth-running cable cutter with needle bearing eccentric drive up to 52 mm Ø. Extremely durable tool



Art. no.

Art. no.		mm ²	Ø
200114			
Cutting range:	Cu/Al wire multi wiring	400	52
	Cu/Al wire sector format	480	52
	Cu wire fine wiring	500	52
	Cu wire fine wiring or telecommunication cable		52
Length:			325
Weight:			1,340

Special cable cutter

High leverage, perfected cutting force performance, for data and telephone cables up to 75 mm Ø, high cutting quality through special cutting geometry, smooth-running due to needle-bearing drive mechanics, not suitable for steel wire and very wiry conductors of power supply (EVU etc.)



Art. no.

Art. no.		mm ²	Ø
200116			
Cutting range:	Cu/Al wire multi wiring	300	75
	Cu/Al wire sector format	240	75
	Cu wire fine wiring	240	75
	Cu wire fine wiring or telecommunication cable		75
Length:			370
Weight:			1,585



single wire



multi-wire



sector-shaped



fine wire



communication/ data



wire rope



armoured steel cable (SWA)



ACSR



BOLT



solid steel



solid CU

INFO

Cable cutters

200115, 200119, 200179:

- Two-hand cable cutters for armoured steel cable
- Dual needle-bearing offset lever 14 mm
- Particularly easy to move, thanks to reduction of friction on joint
- Considerable reduction of manual force
- Lever joint bolts, thickness 12 mm
- Extremely well reinforced version for particularly tough uses
- Locking with a locking shaft
- Accidental opening of handles is prevented
- Integrated toothed comb for cleaning in handle
- Transport handle play is fixed

Cable cutter

High leverage, perfected cutting force performance, almost maintenance-free two-hand cable cutter up to 62 mm Ø, smooth-running through needle-bearing eccentric drive, great range of application, comes with cog comb to clean cogs

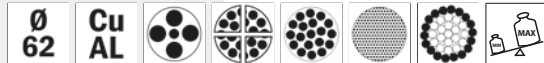

Art. no.

200115

		mm ²	Ø
Cutting range:	Cu/Al wire multi wiring	750	62
	Cu/Al wire sector format	750	62
	Cu wire fine wiring	750	62
	Cu wire fine wiring or telecommunication cable		62
Length:			410
Weight:			2,224

Cable cutters with eccentric drive

Cable cutter



High leverage, perfected cutting force performance, almost maintenance-free quality tool up to 80 mm Ø. Smooth-running due to needle-bearing eccentric drive, also suitable for cables with steel plate jacket and soft steel wire reinforcement, ST 52. Comes with cog comb to clean cogs, integrated in the handle

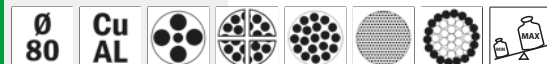

Art. no.

200119

		mm ²	Ø
Cutting range:	Cu/Al wire multi wiring	1000	80
	Cu/Al wire sector format	1000	80
	Cu wire fine wiring	1000	80
	Cu wire fine wiring or telecommunication cable		80
Length:			610
Weight:			3,322

Cable cutter



High leverage, perfected cutting force performance, almost maintenance-free quality tool up to 100 mm Ø. Smooth-running due to needle-bearing eccentric drive, also suitable for cables with steel plate jacket and soft steel wire reinforcement, ST 52. Comes with cog comb to clean cogs, integrated in the handle

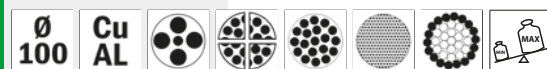

Art. no.

200179

		mm ²	Ø
Cutting range:	Cu/Al wire multi wiring	1400	100
	Cu/Al wire sector format	1400	100
	Cu wire fine wiring	1400	100
	Cu wire fine wiring or telecommunication cable		100
Length:			610
Weight:			3,322

haupa[®]

... convincing solutions

Special cable cutters

Universal cable cutter with eccentric drive



- high leverage, perfected cutting force performance
- one-hand universal- and steel rope cutter with exchangeable cutting segments
- in the case of wear or changing requirements only the cutting segment need to be replaced
- cleaner included
- double needle bearing excenter lever 14mm
- very easy to use through reduction of the attrition of the joint
- strong reduction of the manual force
- lever joint bolt strength 9mm
- central lubrication
- cone fitting in the bolt with cross drilling on the bearing points
- adjustable level of the transport plugs
- opening of the cutter possible at any time, also suitable for the highest demands without additives

Separable materials:

- cable AL /Cu
- cable with soft steel cover
- steel covered ropes
- steel armoured ropes
- niro ropes
- flexible steel ropes
- tracking rope cable
- steel armoured hose
- ACSR DIN 48 204
- constructional steel 235JR+AR
- screws

Complete set:

- universal cable cutter
- 1 pair of cutting segments S1 (art. 200178/S1)
- ACSR

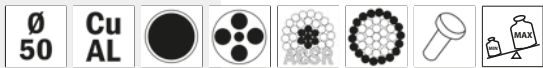

Art. no.	TL	mm ²	fine wiring mm ²	kg	PU
200178	230	300	240	1,140	1



Application: AL/CU: Cross-section: 350 mm², Ø 50 mm
Clean cut and low handgrip with large cross sections suitable for highly flexible conductors not for steel

Art. no.	mm ²	kg	PU
200178/C	350	0,100	1



Application: AL/CU: Cross-section 350 mm², Ø 50 mm
Flexible steel cables: Cross-section 95 mm², Ø 16 mm
Cable with soft steel sleeve: Cross-section 240 mm², Ø 50 mm
Clean cut and normal handgrip

Art. no.	mm ²	kg	PU
200178/S	350	0,100	1



Application: AL/CU: Cross-section 200 mm², Ø 50 mm
Flexible steel cables: Cross-section 95 mm², Ø 14 mm
Niro cables: Ø 8 mm, 19/1
ACSR DIN 48 204: Cross-section 300/50 mm², Ø 24.5, 7/3 mm
Steel armoured tubing: Ø 50 mm
Construction steel 235JR+AR: Ø 10 mm, full material
Screws: Ø 8 mm, 8.8
Can lead to crimping of steel cables are highly flexible, slightly edgy cutaway section, increased handgrip

Art. no.	mm ²	kg	PU
200178/S2	200	0,100	1

Further accessories for cable cutter item no. 200178



Application: AL/CU: Cross-section 300 mm², Ø 50 mm
Flexible steel cables: Cross-section 95 mm², Ø 14 mm
Niro cables Ø 8 mm, 19/1
ACSR DIN EN 50182: Cross-section 150/25 mm², Ø 20 mm, 7/2.1 mm
Steel armoured tubing: Ø 50 mm

Art. no.	mm ²	kg	PU
200178/S1	300	0,100	1



Application: AL/CU: Cross-section 150 mm², Ø 30 mm
Flexible steel cables: Cross-section 70 mm², Ø 12 mm
Supporting cable: Cross-section 70/300 mm², Ø 12/30 mm, Type 8
ACSR DIN 48 204: Cross-section 70/12 mm², Ø 11.7 mm, 7/1.44 mm

Art. no.	mm ²	kg	PU
200178/B	150	0,100	1



INFO

Cable cutters

Precise cut!

The blade joints (screw connection on rotation blade) are adjusted to 0.05 mm!

Durable and strong

Serrations on the blade and the transport handle are milled! The contact pressure is thus lower than for cast teeth.

200124, 200126:

- One-handed cable cutter
- Lever joint bolts, thickness 6.5 mm.
- 16 mm Full material, milled knee lever.
- Transport handle play can be set (2 grub screws 3 mm in lever)

Front cable cutter

for Copper and Alu-cable 25 mm Ø, squeeze-free cutting, optimized lever-transmission



Art. no.

200124

	mm ²	Ø
Cutting range: Cu/Al wire multi wiring	120	25
Cu/Al wire sector format	120	25
Cu wire fine wiring	120	25
Cu wire fine wiring or telecommunication cable		25
Length:		245
Weight:		1,020

Front cable cutter

for Copper and Alu-cable 34 mm Ø, squeeze-free cutting, optimized lever-transmission by eccentric drive system



Art. no.

200126

	mm ²	Ø
Cutting range: Cu/Al wire multi wiring	185	34
Cu/Al wire sector format	240	34
Cu wire fine wiring	240	34
Cu wire fine wiring or telecommunication cable		34
Length:		330
Weight:		1,541

Front cable cutter with eccentric drive



High leverage, perfected cutting force performance, very easy to use precision one-handed front cutter, excellent crush-free cutting quality even with fine wired cables, tried and tested and almost wear-free offset drive, rotation blade can be locked in any position, cutting range up to a diameter of 35 mm.

- One-handed cable cutter
- Dual needle-bearing offset lever 14 mm
- Particularly easy to move, thanks to reduction of friction on joint
- Considerable reduction of manual force
- Lever joint bolts, thickness 8 mm
- For the toughest of usage conditions
- Locking with a locking shaft
- Accidental opening of handles in tool case is prevented
- Transport handle play is fixed



Art. no.

200131

	mm ²	Ø
Cutting range: Cu/Al wire multi wiring	240	35
Cu/Al wire sector format	240	35
Cu wire fine wiring	300	35
Cu wire fine wiring or telecommunication cable		35
Length:		330
Weight:		1,673

Front cable cutter with eccentric drive



High leverage, perfected cutting force performance, easy to use two-handed front cutter with patented offset drive, excellent crush-free cutting quality even for large cross-sections, rotation blade can be locked in any position, cutting range up to a diameter of 55 mm.

- Two-handed cable cutter for armoured steel cable
- Dual needle-bearing offset lever 14 mm
- Particularly easy to move, thanks to reduction of friction on joint
- Considerable reduction of manual force
- Lever joint bolts, thickness 12 mm
- Extremely well reinforced version for particularly tough uses
- Locking with a locking shaft
- Accidental opening of handles is prevented
- Integrated toothed comb for cleaning in handle



Art. no.

200151

	mm ²	Ø
Cutting range: Cu/Al wire multi wiring	550	55
Cu/Al wire sector format	550	55
Cu wire fine wiring	550	55
Cu wire fine wiring or telecommunication cable		55
Length:		485
Weight:		3,493

haupa

... convincing solutions

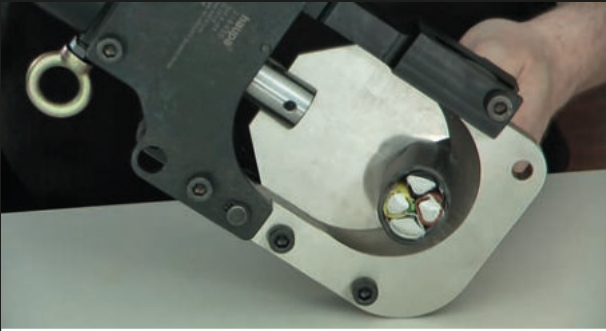
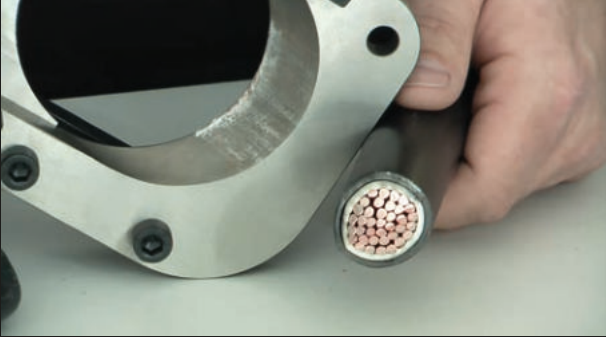

Hydraulic cutting



Hydraulic cable cutters

Hydraulic cable cutter „HH 32-ST“

- in case • cutting head can be rotated 180°
- for copper and aluminium cable • ACSR: Ø 28 mm
- soft CU round bar: Ø 25 mm • soft AL round bar: Ø 22 mm
- soft steel round bar: Ø 16 mm
- CU/AL wire stranded: Ø 32 mm

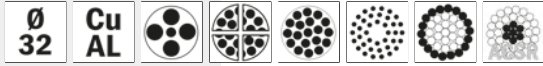

Art. no.	TL	Ø	kg	PU
216402	580	32	5,300	1

Hydraulic cutter „HH 85-ST“

- in case • cutting head can be rotated 180°
- with hydraulic quick connections • copper and aluminium cable
- armoured steel cable

For technical data, see page 22



Art. no.	TL	Ø	kg	PU
216404	690	85	7,000	1

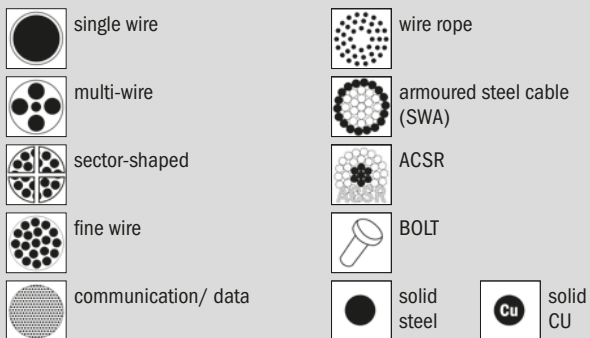

Hydraulic cutting headstocks

Hydraulic cutting headstock

- in bag • with hydraulic quick connections
- copper and aluminium cable • armoured steel cable

For technical data, see page 22

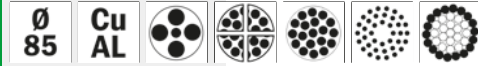
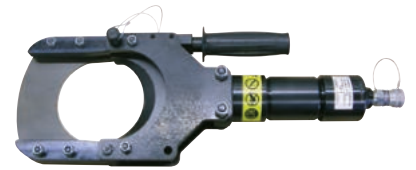

Art. no.	Ø	kg	PU
216408	85	11,300	1

Hydraulic cutting headstock

- in bag • with hydraulic quick connections
- copper and aluminium cable • armoured steel cable

For technical data, see page 22

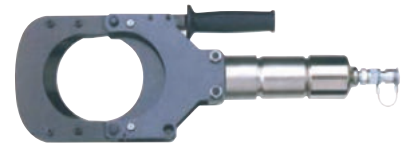

Art. no.	Ø	kg	PU
216410	120	14,600	1

Hydraulic cutting headstock

- in bag • with hydraulic quick connections
- copper and aluminium cable • armoured steel cable

For technical data, see page 22

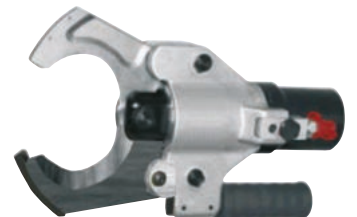

Art. no.	Ø	kg	PU
216415	95	11,300	1

Safety cutting equipment

Hydraulic safety life line cable cutter

used for working under voltage acc. to VDE 0105, part 100.



Consisting of:

- Hydraulic shear with high pressure hose of 10 m, with leak-free coupling system and earth harness acc. to DIN EN 50110-1
- Double piston pump mounted on foot-pedal, with foot-operated switch
- Transport case
- Fully operational and filled with special oil

According to VDE 0105 Part 1 Para. 9.6.4 the cable cutter 216416 is used for cutting low and medium voltage cables up to 60 KV AC. If a live wire is cut by accident, the operator is not in any danger.

The 10 m long high pressure hydraulic hose, which connects the pump to the cutting head, guarantees the highest standard of safety due to its special insulating features. The cutting process is controlled by watching the manometer attached to the pump, since, in general, the cutting head cannot be seen when a cable is cut. This process has been tested repeatedly at medium voltage, with live wires and continuing main supply.

The cutting range goes up to 85 mm. The 12 mm cutting blades are made of high yield point steel and are polished, thus wear- and tear-resistant. A strongly dimensioned guidance of the blades guarantees a high degree of mechanical stability. Even in the event of a short circuit, a safe cutting of the wires is guaranteed, since the individual blades overlap by approx. 20 mm. The blades open themselves when pressure is reduced. The high pressure hose bursts at 2700 bar. The pressure relief safety system of the pump has been adjusted at a 625 bar level.



Art. no.	Ø	NP	kg	PU
216417	85	625 bar	32,000	1

Hydraulic safety life line cable cutter



Art. no.	Ø	NP	kg	PU
216421	95	625 bar	33,000	1

Hydraulic safety life line cable cutter



Art. no.	Ø	NP	kg	PU
216416	120	625 bar	36,600	1
216416/850	120	850 bar	36,600	1

single wire	wire rope
multi-wire	armoured steel cable (SWA)
sector-shaped	ACSR
fine wire	BOLT
communication/ data	solid steel
	solid CU

haupa[®]

... convincing solutions

HAUPA GmbH & Co. KG, Koenigstr. 165-169, 42853 Remscheid, Phone: +49 (0)2191 8418-0, Fax: +49 (0)2191 8418-840, sales@haupa.com

Battery powered cable cutters

Battery powered cable cutter „AS-52“

- for copper and aluminium cable, multi wire
- diameter up to 52 mm

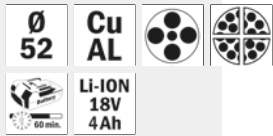

Art. no.	Ø	kg	PU
216434-1	52	7,130	1
216434-1-NO	52	5,733	1
216434-1-N	52	2,817	1

Battery powered cable cutter „AS-52F“

- for copper and aluminium cable
- with blades for fine-stranded cables

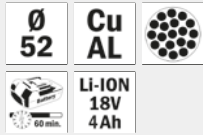

Art. no.	Ø	kg	PU
216436/F-1	52	7,480	1
216436/F-1-NO	52	6,081	1
216436/F-N	52	3,165	1

Battery powered cable cutter „AS-65“

- for copper and aluminium cable
- diameter up to 65 mm

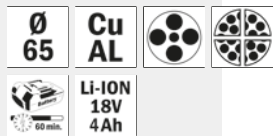

Art. no.	Ø	kg	PU
216435-1	65	7,200	1
216435-1-NO	65	3,500	1
216435-1-N	65	2,900	1

Scope of delivery for all battery-hydraulic cable cutters:
1 tool, 1 quick charger and 1 rechargeable battery in SysCon or system case incl. Insert.

For versions -NO: no battery, no charger
For versions -N: only machine in transport packaging

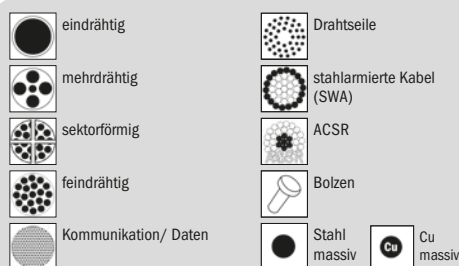

Battery powered cable cutter „AS-52ACSR“



- Diameter 18,6 mm / 120 mm²
- ACSR 19 mm
- not suitable for Cu/Al

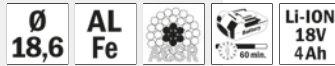

Art. no.	Ø	kg	PU
216436-1	18,6	7,480	1
216436-1-NO	18,6	6,081	1
216436-1-N	18,6	3,165	1

Battery powered cable cutter „AS6-S20“



hydraulic for cutting telecommunications cables, cutting head can be rotated by 180°, manual return after the cut has been completed.

Scope of delivery: 1 cutting tool, 1 quick charger, 1 battery, 1 carry strap loop, in SysCon stacking box.

- Pressing force kN: 60 kN
- Working pressure in bar: 700
- Cutting width Ø: 20
- Battery charging time in minutes: 30
- Battery type: Li-Ion, 18 V, 2 Ah
- With the new HAUPA battery item no. 215523 and charger item no. 215527
- ACSR
- Sheet and wire armouring Cu
- Wire rope, bracing wire
- Soft rod steel
- Lead sleeve cable

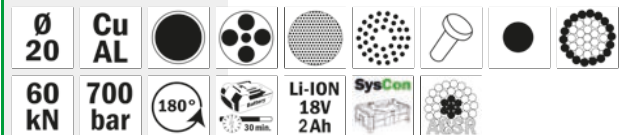

Art. no.	Ø	kg	PU
216418-1	20	6,722	1
216418-1-NO	20	5,553	1
216418-1-N	20	2,637	1

Battery powered wire cutter „AS6-S32“

Hydraulic for cutting telecommunications cables, cutting head can be rotated by 180°, manual return after the cut has been completed.

- Pressing force kN: 60 kN
- Working pressure in bar: 700
- Cutting width Ø: 32
- Battery charging time in minutes: 30
- Battery type: Li-Ion, 18 V, 2 Ah
- With the new HAUPA battery item no. 215523 and charger item no. 215527

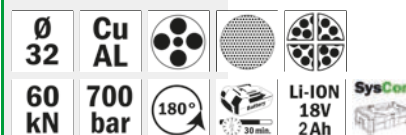

Art. no.	Ø	kg	PU
216419-1	32	7,640	1
216419-1-NO	32	6,471	1
216419-1-N	32	3,555	1



Hydraulic cable cutters

Battery powered cable cutter „AS6-40“

Cutting head can be rotated by 180°, manual return, LED for battery control, 1 quick charger, 1 battery, carrying belt, for copper and aluminium cable. The unit also has 2 white LED's to illuminate the respective work area.

- Pressing force kN: 60
- Working pressure in bar: 700
- Cutting width Ø: 40
- Battery charging time in minutes: 60
- Battery type: Li-Ion, 18 V, 4 Ah



Ø 40	Cu AL			
60 kN	700 bar	180°		LI-ION 18V 4Ah

Art. no.	Ø	TL	kg	PU
216422-1	40	385	10,289	1
216422-1-NO	40	385	8,890	1
216422-1-N	40	385	5,640	1

Battery powered cable cutter „AS12-52“



Cutting head can be rotated by 180°, manual return, LED for battery control, 1 quick charger, 1 battery, carrying belt, for copper and aluminium cable as well as armoured steel cable. The unit also has 2 white LED's to illuminate the respective work area.

- Pressing force kN: 120
- Working pressure in bar: 700
- Cutting width Ø: 52
- ACSR
- Battery charging time in minutes: 60 • Battery type: Li-Ion, 18 V, 4 Ah



Ø 52	Cu AL					
120 kN	700 bar	180°		LI-ION 18V 4Ah		

Art. no.	Ø	GL	kg	PU
216424-1	52	385	13,129	1
216424-1-NO	52	385	11,730	1
216424-1-N	52	385	8,480	1

Battery powered cable cutter „AS6-85“

Cutting head can be rotated by 180°, manual return, LED for battery control. The unit also has 2 white LED's to illuminate the respective work area.

- Pressing force kN: 60 • Working pressure in bar: 700
- Cutting width Ø: 85 • Battery charging time in minutes: 60
- Battery type: Li-Ion, 18 V, 4 Ah



Ø 85	Cu AL			
60 kN	700 bar	180°		LI-ION 18V 4Ah

Art. no.	Ø	TL	kg	PU
216428-1	85	385	12,949	1
216428-1-NO	85	385	11,550	1
216428-1-N	85	385	8,300	1

Battery powered cable cutter „SAS6-85“



Cutting head can be rotated by 180°, manual return, LED for battery control. For copper and aluminium cable as well as armoured steel cable, telephone cable. The unit also has 2 white LED's to illuminate the respective work area.

- Pressing force kN: 60
- Working pressure (bar): 700
- Cutting width Ø: 85
- Armoured steel cable
- Battery charging time in minutes: 120 • Battery type: Li-Ion, 18 V, 4 Ah



Ø 85	Cu AL					
60 kN	700 bar	180°		LI-ION 18V 4Ah		

Art. no.	Ø	TL	kg	PU
216430-1	85	385	12,959	1
216430-1-NO	85	385	11,560	1
216430-1-N	85	385	8,310	1

Battery powered cable cutter „AS12-S85“

Cutting head can be rotated by 180°, manual return, LED for battery control, for copper and aluminum cables. The unit also has 2 white LEDs to illuminate the respective work area.

- Pressing force kN: 120
- Working pressure in bar: 700
- Battery charging time in minutes: 60
- Battery type: Li-Ion, 18 V, 4 Ah



Ø 85	Cu AL				
120 kN	700 bar	180°		LI-ION 18V 4Ah	

Art. no.	Ø	TL	kg	PU
216425-1	85	385	16,149	1
216425-1-NO	85	385	14,750	1
216425-1-N	85	385	11,500	1

Hydraulic cutting tools



Art.	216418-1	216419-1	216422-1	216424-1	216428-1	216430-1	216425-1	--	--
Typ	AS6ST-20	AS6S-32	AS6-40	AS12-52	AS6-85	SAS6-85	AS12-S85	--	--

Hand hydraulic cutting tools

Art.	--	--	--	--	--	216404	--	--	--
Typ	--	--	--	--	--	HS-85	--	--	--

Hydraulic cutting heads

Art.	--	--	--	--	--	216408	--	216415	216410
Type	--	--	--	--	--	KS-85	--	KS-95	KS120
Diameter	20	32	40	52	85	85	85	95	120
Head	swivel	open	swivel	swivel	swivel	swivel	open	offen	swivel
Output force	6	6	6	12	6	700 bar	700 bar	700 bar	700 - 850 bar
Immediate motor-stop	●	●	●	●	●	●	●	●	●

Material

Copper	20	32	40	52	46	85	85	95	120
Aluminium	20	28	40	52	28	85	85	95	120
Underground cable	--	--	40	52	50	85	85	95	120
Telephone cable	--	--	40	--	85	85	85	95	120
ACSR	●	--	--	32	--	--	--	--	--
Drahtseil (Aluminium - Stahlseil)	●	--	●	●	--	--	--	●	●
Spanndraht	16	--	22	●	--	--	--	22	22
	20	--	25	●	--	--	--	25	25
	20	--	25	●	--	--	--	25	25
	●	--	--	●	--	--	--	●	●
	20	--	20	●	--	--	--	15	15
	20	--	25	●	--	--	--	20	20
Soft steel bar	(under SS41) 13 mm	--	16	25	--	--	--	--	--
Sheetmetal & Wire armouring, Cu	20	--	--	●	--	85	85	95	120
Lead sheathed cable	20	--	40	52	85	85	85	95	120

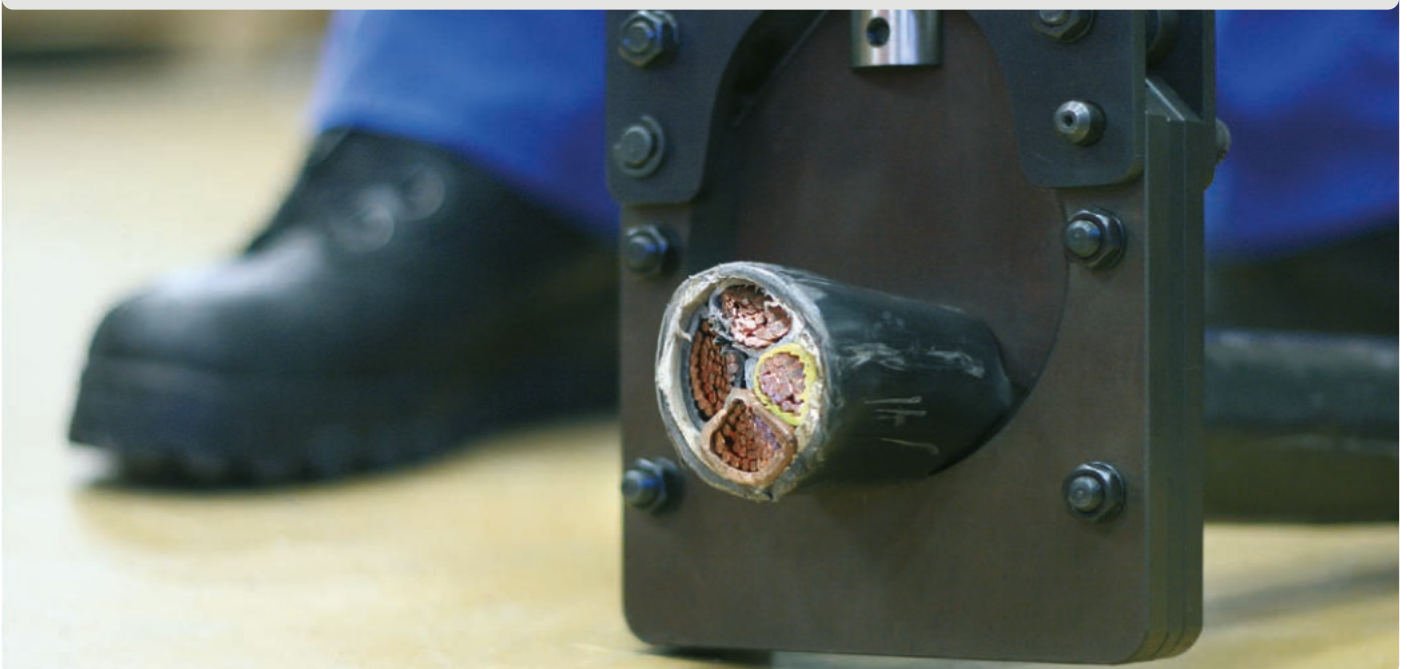

Stripping



INFO

Cable strippers

Information for strippers

Stripping removes the outer sleeve of a installation cable. For cables that have already been installed in installation sockets and are thus difficult to access, you use a round stripper. When stripping, open the stripper and place it on the cable in such a way as to ensure that the round blade is position at the point of the sleeve you wish to remove. Turn the stripper a quarter turn to the left and to the right, bend the cable a little, and open up the stripper. Place the tool closer to the end of the cable, close again, and stripper the sleeve away easily. There is a variety of strippers available for the various types of cable.

Important: Important, when stripping the insulation of inner wires may not be damaged.

Cable stripper „Kabifix“

- For cutting opening and stripping cables from Ø 6 - 25 mm
- Longitudinal and round cut (swivel lever)
- Ø 6 - 28 mm • NYY 4 - 16 mm² • NYM 5 - 16 mm²
- Coaxial and bell round cable
- Isoflex and PVC piping maximum Ø 25 mm
- Interior adjustment screw for adjusting the cutting depth
- Exchangeable blades



Art. no.	Ø	kg	PU
200022	6 - 28	0,096	1
200024	6 - 28	0,010	1
		spare blades	

Cable stripper „Kabifix LWL“

- For cutting opening and stripping fibre-optic and coaxial cables from Ø 6 - 25 mm
- Longitudinal and round cut (swivel lever)
- Interior adjustment screw for adjusting the cutting depth
- Exchangeable blades



Art. no.	Ø	kg	PU
200023	6 - 25	0,136	1
200023/M	6 - 25	0,003	1
		spare blades	

Cable strippers for short-circuit proof lines



- For stripping current energy and safety cables
- For stripping short-circuited and grounded, flame retardant, halogen-free cables, e.g. NSGAFÖU, VER H07RN-F
- With lengthwise stop 8 - 10 - 12 mm for even stripping lengths
- For stripping safety and energy cables
- No need to set blades required to cutting depth
- For stripping dual insulated solar cables



Art. no.	Ø	kg	PU
200630	1,5	0,054	1
200632	2,5 - 6	0,054	1
200634	10 - 16	0,054	1

„System 4 - 70“ cable stripper



Cable stripping knife system with automatic blade protection and interchangeable bracket for stripping any popular round cables. (Main body plus interchangeable bracket item no. 201044, 1 spare blade in the handle)

Scope

- Ø 4 - 70 mm cutting depth
- Inner blade: 35 mm
- Hook blade cutting depth: Level 1: 2.8 mm / Level 2: 3.4 mm / Level 3: 4.0 mm / Level 4: 4.6 mm
- Cable types: Round cable for flexible and fixed installation, moisture-proof cable



Art. no.	Ø	kg	PU
201040	4 - 70	0,068	1

„Profi set“ cable stripping system 4 - 70



In shockproof plastic boxes, stackable, dimensions: (L 260mm, W 154mm, H 57mm) Set: 6-piece

Contents:

- 201040
- 201042
- 201044
- 201046
- 201048
- 201050



Art. no.	Ø	kg	PU
201054	4 - 70	0,673	1

Interchangeable bracket

Suitable for cable stripping system 4 - 70 (item no. 201040)



Art. no.	Ø	kg	PU
201042	4 - 16	108 x 28 x 33	0,031 1
201044	8 - 28	108 x 28 x 33	0,031 1
201046	27 - 35	133 x 15 x 49	0,060 1
201048	35 - 50	141 x 15 x 56	0,070 1
201050	50 - 70	156 x 15 x 69	0,086 1

Replacement hook blades

Suitable for cable stripping system 4 - 70 (art. no. 201040)



Art. no.	Ø	kg	PU
201052	4 - 70	0,007	1

Cable strippers

Cable stripping knife

- For removing the sleeve from all current round cables
- Blades, titanium nitride coated, thanks to the higher cutting speed
- Lower wear, increased durability
- Cutting depth can be adjusted using the setting screw on the end of the handle
- Automatic adjustment to round and lengthwise cuts
- Handle security thanks to soft component insert on the bar and handle
- Titanium nitride coated replacement blade in the housing
- Housing made from high-quality, hard wearing polyamide
- With titanium nitride coated hook blade



Art. no.	Ø	kg	PU
200031 *	8 - 28	0,100	1
200046	spare blades	0,004	1

Cable stripping knife

- For removing the sleeve from all current round cables
- Blades, titanium nitride coated, thanks to the higher cutting speed
- Lower wear, increased durability
- Cutting depth can be adjusted using the setting screw on the end of the handle
- Automatic adjustment to round and lengthwise cuts
- Handle security thanks to soft component insert on the bar and handle
- Titanium nitride coated replacement blade in the housing
- Housing made from high-quality, hard wearing polyamide



Art. no.	Ø	kg	PU
200038 *	4 - 16	0,090	1
200040	8 - 28	0,091	1
200042	28 - 35	0,101	1
200044	35 - 50	0,108	1
200046	35 - 50	spare blades	0,004

Stripper standard

- For removing the sleeve from all current round cables
- Blades, titanium nitride coated, thanks to the higher cutting speed
- Lower wear, increased durability
- No need to set blades required to cutting depth
- Fixture clip for safe storage
- Housing made from high-quality, hard wearing polyamide



Art. no.	Ø	kg	PU
200036	8 - 13	0,065	1

Stripper „All-rounder“

- Cable stripper for round cables from Ø 4 - 15 mm and flat cables up to 15 mm width
- Stripping 1.5 - 2.5 mm² single wire • Lengthwise cut



Art. no.	Ø	kg	PU
200050 *	4 - 15	0,111	1

„XL“ cable stripper

Use: For stripping round cables with a round cut, extra long for deep flush-mounted boxes
 Scope: 8 - 13mm
 Cable types: Round cable for flexible and fixed installation, moisture-proof cable

Material:
 Casing: Polyamide (PA),
 Blade: Speciality steel, hardened, coated with titanium nitride



Art. no.	Ø	kg	PU
201045	8 - 13	0,068	1

Universal stripper

- Stripper for removing the sleeve from all current round cables Ø 8 to 13 mm
- Removing the insulation on various cable types, e.g. NYM 3 x 1.5 mm² to 5 x 2.5 mm²
- Contoured blades for stripping wires 0.2-0.3-0.8-1.5-2.5-4.0 mm²
- Ideal for working in distribution and junction boxes
- Longer cable lengths can be stripped using the lengthwise cutting mechanism
- Safe hold thanks to the inclusion of anti-slip handle zones
- No need to set blades required to cutting depth
- Additional titanium nitride coated retractable blade



Art. no.	Ø	kg	PU
200043 *	8 - 13	0,063	1

Flatcable stripper

For stripping round cables with rubber or hard plastic sleeves and flat cables up to 12 mm in width (e.g. NYM cable 4 3 x 1.5 to 5 x 2.5 mm², insulated flat cables of flexible cables).

- Stripping tool for cables and litz wire 0.8 - 1.5 - 2.5 mm²
- Ideal for working in tight and difficult to access areas
- Additional blade for lengthwise cut
- Fixture clip for safe storage



Art. no.	Ø	kg	PU
200037	4 - 13	0,068	1

„Top Coax Plus“ cable stripper

Use: For stripping all popular coaxial cables and tightening F connectors (HEX 11)
 Scope: Ø 4.8 - 7.5mm F connectors (HEX 11)

Cable types:
 Standard coaxial cable, e.g. TV coax, RG58U/RG59U, RG6, PVC flex 3 x 0.75mm²



Art. no.	Ø	kg	PU
201058	4,8 - 7,5 mm	0,320	1

haupa[®]

... convincing solutions

Cable strippers

Hex socket wrench for coax

- for items 201058



Art. no.	SW	kg	PU
201059	11	0,080	1

Stripper for coaxial cable

- For removing the sleeve from all current coaxial cables \varnothing 4,8 to 7.5 mm
- For stripping various cable types, e.g. TV coax, RG 58 / RG 59, PVC flex 3 x 0.75 mm²
- New closure system
- Safe hold thanks to the 2-component handle shells
- Blades, titanium nitride coated, thanks to the higher cutting speed
- Lower wear, increased durability
- 2 blade pairs for two-stage stripping
- Cutting depth does not need to be set
- No damage to the inner sheath and inner cable elements
- Easily recognised, internal length scale



Art. no.	\varnothing	kg	PU
200636 *	4,8 - 7,5	0,041	1

Stripper for coaxial cable

- For coaxial cables, RG-58, RG-59/62, RG-6 and 6QS
- With 3 replaceable and individually adjustable blades
- Cutting distance of 8 and 4 mm



Art. no.	Crimp	kg	PU
200069	RG 58-59-62-6	0,048	1

PC-Strip

- For stripping round cables \varnothing 5 - 13 mm
- For stripping various cable types, e.g. IBM Type 1, Type 2, flexible cables, etc.
- For stripping PVC insulated data, communication and control cables
- With stripping tool for cables and litz wire from 0.2 - 4 mm²
- Blades, titanium nitride coated, thanks to the higher cutting speed
- Lower wear, increased durability
- No need to set blades required to cutting depth



Art. no.	\varnothing	kg	PU
200039	5 - 13	0,064	1

PC-Cat

- For stripping round cables \varnothing 4.5 - 10 mm
- Stripping various cable types, e.g. CAT 5, CAT 6, CAT 7, Twisted-Pair cable
- With stripping tool for cables and litz wire from 0.2 - 0.8 mm²
- For stripping PVC insulated CAT and network cables
- Blades, titanium nitride coated, thanks to the higher cutting speed
- Lower wear, increased durability
- No need to set blades required to cutting depth



Art. no.	TL	\varnothing	kg	PU
200637	125	4,5 - 10	0,062	1

No.1-Cat

- For stripping PVC insulated data, communication and control cables \varnothing 4.5 - 10.0 mm
- Cat5, Cat6, Cat7, Twisted-Pair cable
- Blades, titanium nitride coated, thanks to the higher cutting speed
- Lower wear, increased durability
- 2 blade pairs for outer sleeve and foil sheath
- Cutting depth does not need to be set
- With length scale



Art. no.	TL	\varnothing	kg	PU
200638	128	4,5 - 10	0,050	1

Stripper for UTP-/STP-data cable

Universal tool for cutting, stripping and removing the sleeve from round and flat cables, sheathed and unsheathed cables.

- Cutting depth can be set
- Exchangeable blades
- For cable with a diameter of 3.5 to 9 mm



Art. no.	\varnothing	kg	PU
200068 *	3,5 - 9	0,060	1

Precision stripper PWS Plus

Areas of application: Data processing equipment, control device production, telecommunication, 3 integrated functions:

- Precise stripping from AWG 30 (0.25 mm² \varnothing) to AWG 20 (0.8 mm² \varnothing)
- Adjustable straight dog up to 15 mm
- Wire cutter up to 0.8 mm \varnothing (CU cable)



Art. no.	\varnothing	kg	PU
200033	0,25 - 0,8	0,039	1

Sensor Tool LSA

Standard tool for all data, information and telecommunication cables with cutting mechanisms, hook and blade

- Cable diameter: 0.35 - 0.9 mm
- Core diameter: 0.7 - 2.6 mm



Art. no.	\varnothing	kg	PU
300322 *	0,35 - 0,9	0,078	1

Stripping pliers

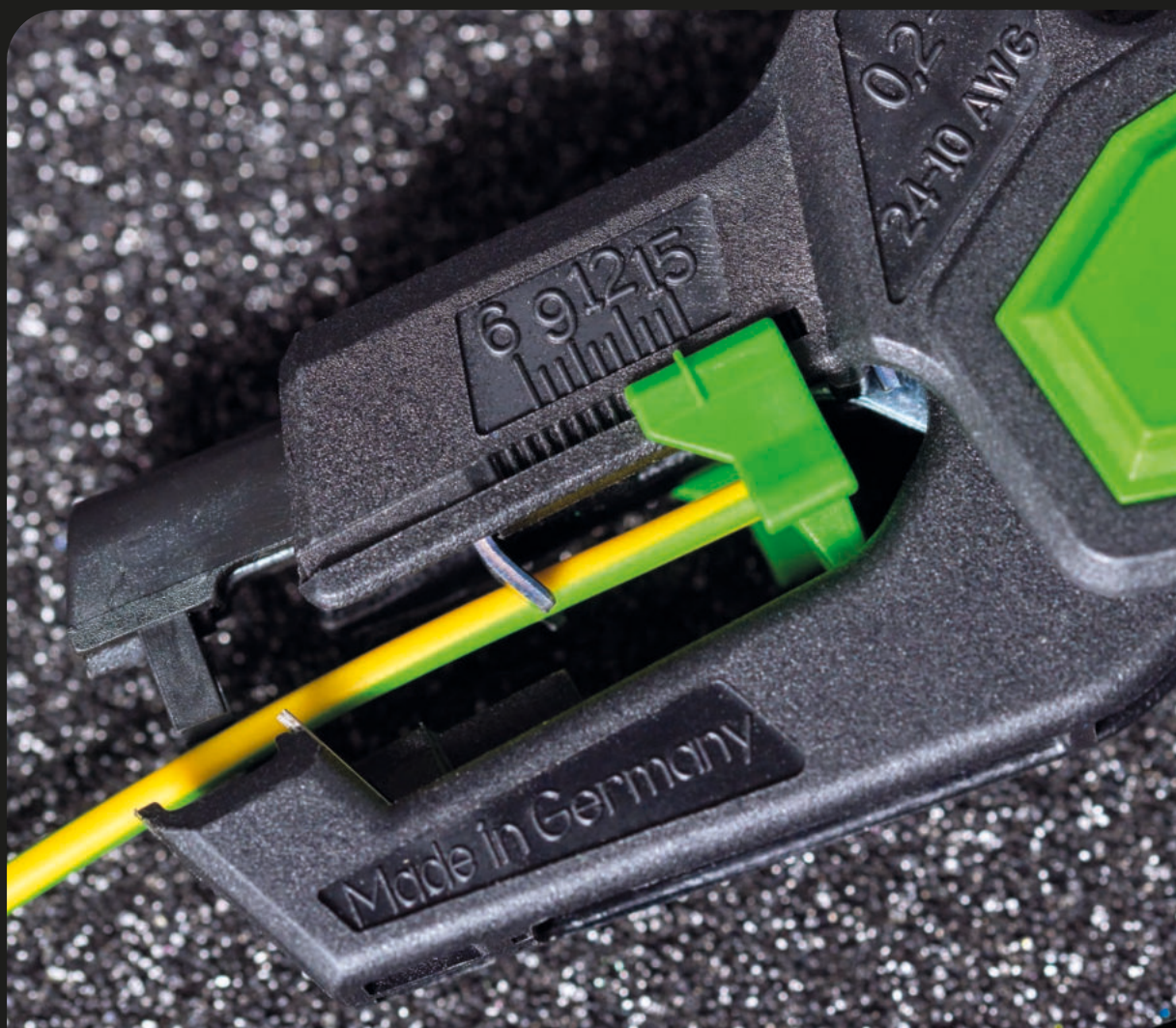

INFO

Wire strippers

Stripping is the removal the insulation on an electrical cable (wire). The following stripping pliers are used to do this:

Manually adjustable stripping pliers

Are set by hand to the stripping diameter by eye. The risk of damaging the cable is thus very high.

Automatic or self-adjusting stripping pliers

For fast and precise cutting and stripping. These tools automatically adjust to the required cable cross-section or insulation thickness. Thus it is not possible to damage the cable or the insulation. A lengthwise stop makes serial insulation easier.

Micro-precision stripping tools

These are used when fine wires are to be stripped. Data technology, network technology, controller construction, telecommunications, electronics, model construction.

Stripping tools for special insulation types

Teflon insulations are a rubber-like insulation type which make removing the insulation of an electrical cable more difficult. In such tough situations we recommend stripping tools that cut the insulation sleeve.

Advantages

- Constant safe stripping results
- Fault free processing
- Precision in every cut
- Serial stripping is made easier by lengthwise stop
- Automatic stripping pliers = 3 in 1 = cut + remove sleeve + strip

Cable stripper, manual

Multi-functional tool including cable cutter for copper cable.

- Comfortable handles
- Precise removal of sleeve thanks to formed blade
- Cutting function
- Gripping function
- With handle lock



Art. no.	TL	mm ²	kg	PU
210620 *	175	0,5 - 2,5	0,158	1
210622	175	0,5 - 1,5	0,158	1
210624	175	0,25 - 0,75	0,161	1

Cable stripper, manual optical fibre

Multi-functional tool for fibre optic cables.

- For slicing open and cutting cables
- Cutting depth can be set
- Specially designed for use with fibre optic cables (outer sleeves and buffer)
- With handle lock



Art. no.	TL	mm ²	kg	PU
200057 *	150	0 - 0,18	0,120	1

Wire strippers

Cable stripper, automatic

- No damage to the cable
- Sleeve is removed according to standard from fine wire cables
- Replaceable blade made from special steel
- Robust metal body
- A pressure spring returns the cutters to the starting position
- Also ideally suited for use with fibre optic cables.



Art. no.	TL	mm ²	kg	PU
210691	165	0,5 - 2	0,340	1
210692 *	165	1 - 4	0,350	1

Wire stripper „High Strip“

- Suitable for cables with problematic insulation types, e.g. rubber, silicone, TPE, etc.
- For cable sized 0.5 - 0.75 - 1.5 - 2.5 - 4.0 mm²,
- Adjustable lengthwise stop 5 to 15 mm,



Art. no.	TL	mm ²	kg	PU
210684	170	0,5 - 4	0,130	1

Wire strippers

Automatic wire stripper Super Plus

for solid and flexible conductors and strands between 0.2 and 6.0 mm² (AWG 24 - 10)

- For fast and precise stripping even of difficult - to-access places
- No adjustment to wire cross section necessary
- Suitable for cables with insulation made from PVC and other materials
- Special scanning system, therefore no damage to conductors
- Adjustable longitudinal stop from 6.0 to 15.0 mm for even serial stripping
- External side cutters for conductors up to 2.5 mm²
- Body of pliers made from fibre-glass reinforced polyamide
- Handle of pliers with elongated hole at the bottom for mounting



Art. no.	TL	mm ²	kg	PU
210695 *	170	0,2 - 6	0,088	1
210695/E		spare blades	0,010	1

Automatic wire stripper Super4Pro

- ergonomic, automatic wire stripper for PVC insulated wires from 0.2 - 6.0 mm² (AWG 24 - 10)
- plier-handle design with soft, non-slip safety grip
- for speedy and precise stripping of wires even where acces is difficult
- wire cutter for diameters of up to 2.5 mm²
- length stopper adjustable from 6 to 15 mm
- plier-handle design with lockable design



Art. no.	TL	mm ²	kg	PU
210698	165	0,2 - 6	0,094	1

Automatic wire stripper Secura

- For single, multiple and fine wire cables from 0.2 to 6.0 mm²
- Ergonomic, automatic strippers
- Increased operating comfort thanks to anti-slip soft components on the stripper handle
- Automatic, energy-saving scanning system
- Cable cross-section does not need to be set
- Optimally positioned side cutter for up to 2.5 mm²
- Adjustable lengthwise stop 6 to 18 mm for same sleeve removal lengths when carrying out series work
- Exchangeable blades



Art. no.	TL	mm ²	kg	PU
210696	180	0,2 - 6	0,151	1
210696/2		spare blades	0,030	1

Wire stripper / Solar



- For cables with large cross-sections from 6.0 to 16 mm²
- Also for stripping PVC flex 3 x 0.75 mm² or solar cables Solarflex-X PV1-F
- Automatic strippers
- Optical lengthwise stop to 20 mm
- Cable cross-section does not need to be set
- Any stripping length can be selected as needed
- Exchangeable blades



Art. no.	TL	mm ²	kg	PU
210685	160	6 - 16	0,147	1

Flat cable pliers

- For PVC insulated flat cables up to a maximum of 12 mm in width and a cross-section of 0.75 x 2.5 mm²
- Automatic strippers
- Optical lengthwise stop to 20 mm
- Strippers do not need to be set
- Any stripping length can be selected as needed
- Exchangeable blades



Art. no.	TL	mm ²	kg	PU
210686	160	0,75 - 2,5	0,148	1

haupa[®]

... convincing solutions

Wire strippers

Wire stripper Sensor Mini



The HAUPA Sensor Mini has a specially designed blade geometry with a working area as of 3.2 mm Ø for sensor cables with smaller cross-sections.

- Automatic wire strippers for stripping combination wires for connecting sensor actuators, distribution boxes/bus couplings
- Any length can be stripped
- No need to make setting to the cable cross-section
- Blades can be replaced



Art. no.	Ø	kg	PU
210730	> 3,2	0,121	1

Wire stripper sensor special



Automatic stripper for stripping combination cables for connection of sensor actuators, distribution boxes/bus couplings. For stripping halogen-free screened or unscreened sensor actuator cables with PUR or PVC exterior sleeve and a cable construction with 3 to 8 cores.

- e.g. sensor cable 3 x 0.34 mm² unscreened up to 8 x 0.25 mm² screened
- Any stripping length
- Cable cross-section does not need to be set
- Exchangeable blades



Art. no.	TL	Ø	kg	PU
210729	180	4,4 - 7,0	0,122	1

Cable stripper ASI, automatic



For stripping AS interface cables with TPE/PUR exterior insulation. For use in connecting actuator-sensor interface components.

- Blade contour designed for use with the AS interface cable
- Strippers do not need to be set
- Any stripping length can be selected as needed
- Exchangeable blades



Art. no.	TL	kg	PU
210693	160	0,117	1
210693/1	spare blades	0,030	1

Cable stripper Outlet 20/55



Article number 210697

- For stripping round cable Ø 7.5 to 9 mm
- Insulation thickness of cable maximum 1.2 mm
- Ideal for processing NYM cables 3 x 1.5 mm to 5 x 1.5 mm²
- Compatible with the Cable Outlet laying system from OBO Bettermann or R & M

Article number 210699

- For stripping round cable Ø 7.5 to 9 mm
- Insulation thickness of cable maximum 1.65 mm
- Ideal for processing NYM cables 3 x 1.5 mm to 5 x 1.5 mm²
- Coaxial cable, screened or unscreened measuring control and control cables

Suitable for connecting potential equalising, screened connection system or grounding clips.



Art. no.	TL	Ø	kg	PU
210697	160	7,5 - 9	55	0,104 1
210699	160	7,5 - 9	20	0,100 1



Automatic cable stripper

Automatic cable stripper



- For stripping fine wires and solid cables 0.08 - 2.5 mm²
- Stripping length, maximum 15 mm
- Automatic setting to the cross-section
- Integrated side cutter of up to 6 mm²
- With stripping lengthwise stop



Art. no.	TL	mm ²	kg	PU
211928	160	0,08 - 2,5	0,156	1
211928/1		spare blades	0,005	1

Automatic cable stripper



- For stripping fine wires and solid cables 0.08 - 6 mm²
- Automatic setting to the cross-section
- Integrated side cutter of up to 6 mm²
- With stripping lengthwise stop



Art. no.	TL	mm ²	kg	PU
211930 *	205	0,08 - 6	0,255	1
211930/1		spare blades	0,005	1

Automatic cable stripper



- For stripping fine wires and solid cables 0.03 - 10 mm²
- Automatic setting to the cross-section
- Integrated side cutter of up to 10 mm²
- With stripping lengthwise stop



Art. no.	TL	mm ²	kg	PU
211934	205	0,03 - 10	0,413	1

Automatic cable stripper



- For stripping fine wires and solid cables 6 - 16 mm²
- Automatic setting to the cross-section
- Integrated side cutter of up to 6 mm²
- With stripping lengthwise stop



Art. no.	TL	mm ²	kg	PU
211932	205	6 - 16	0,250	1
211932/1		spare blades	0,005	1

haupa[®]

... convincing solutions

HAUPA GmbH & Co. KG, Koenigstr. 165-169, 42853 Remscheid, Phone: +49 (0)2191 8418-0, Fax: +49 (0)2191 8418-840, sales@haupa.com

**Automatic
Wire stripping pliers
Wiring**
• Switch/Socket
Art. 210696



**PC Strip
PV/solar cables**
Art. 200630/32/34



**Wire stripping pliers
PV/solar cables**
Art. 210685



**Cable stripping knife with hook blade
Cable installation**
• Main cable feed
• Sub-distribution
Art. 200031



**Universal stripper
House installation**
• Cavity wall sockets
Art. 200043



**PC Cat
House network**
Art. 200637



**Stripper for coaxial cable
TV, hi-fi systems**
Art. 200636



**Precision stripper
PWS Plus**
Intercom systems, alarm systems,
leisure activities, bicycle illumination
Model railways
Art. 200033



**„Coaxi“ stripper
TV, hi-fi systems**
Art. 201058



Strippers for building installation work

Stripping

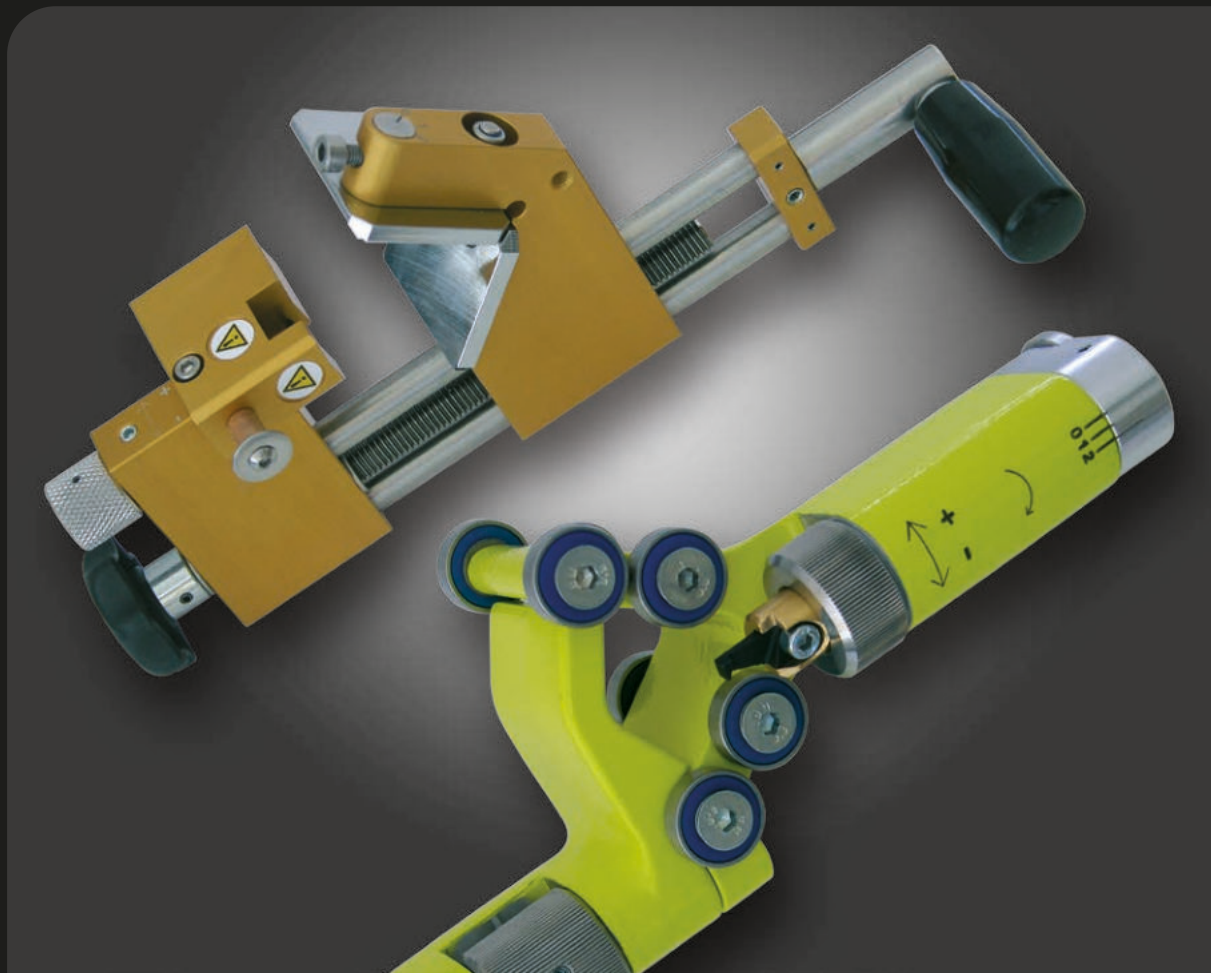

INFO

Cable strippers

Stripping refers to the removal of the outer sleeve of the cable. A special tool is used to first cut in a ring around and then along the length of the cable. Cable sleeve cutters are available in a wide variety of versions.

Important:

When stripping, the insulation of the inner wires and the wires themselves may not be damaged.

Cable sheath cutter



for removing all insulating layers from cables with diameters as of 25 mm

- Replaceable dual blade
- Cutting depth can be set to a max. of 5 mm
- Suitable for lengthwise and circular cuts

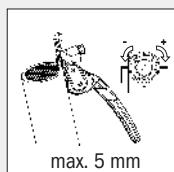

Art. no.	∅	kg	PU
110581	>25	0,220	1

Stripping pliers

For cutting and removing the cable sheathing of low and medium-high voltage cables



Art. no.	TL	∅	kg	PU
200187	260	26 - 52	0,760	1
200188	290	47 - 75	1,100	1

Stripping tool for medium-high voltage cable

A universal tool for controlled and safe stripping of the firm extruded exterior semi-conductor layer of medium-high voltage cable with 10-30 KV and for greater voltage levels. Working range 10-50 mm.

- Stripping depth can be set
- Defined round cut
- Automatic work feed

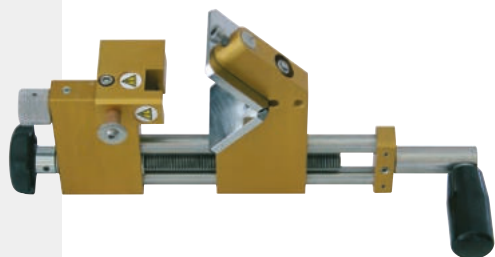

Art. no.	∅	kg	PU
200520	10 - 50	0,800	1
200520/1	repl. blade set	0,100	5

Cable sheath strippers

Cable Sheath Stripper

A combination tool for all standard cross-sections in the medium-high voltage range for VPE single-core cables.

Cutting and stripping the exterior sleeve and the inner cable insulation. Two feeds and a zero setting can be set to ensure precise stripping. The sleeve is lifted at the cutting point and this prevents damage to the construction elements below.

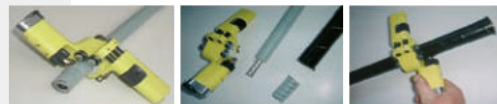

Art. no.	∅	mm ²	kg	PU
200524	15 - 55	35 - 500	0,800	1
200524/1		spare blades	0,020	1

Edge cutter

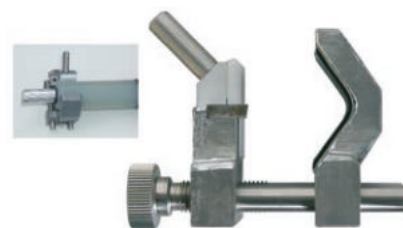

Art. no.	∅	kg	PU
200526	40	0,100	1
200528	60	0,100	1

Complete assembly case



Content:

- Sleeve cutter
- Plastic prism
- Stripping device
- Silicone paste
- Edge cutter
- Key for changing blades



Art. no.	mm ²	kg	PU
200522	35 - 500	0,800	1

Pressing and crimping





0.5

A-6

2.5

1.5

Crimping pliers for Photovoltaic

INFO

Photovoltaic

The photovoltaic energy conversion is carried out with the assistance of solar cells that are connected in order to form solar modules in photovoltaic plants. The generated electricity can be stored on site in accumulators or fed into the power network. If the energy is fed into the public power network then the direct current generated by the solar cells will be converted by a converter into alternating current. In order to constantly make energy available, the energy must be stored.

Crimping pliers

with locking device, with adjustable crimp pressure, chrome plated **square crimp (MC 3), roll crimp (MC 4)**



Art. no.	mm ²		kg	PU
211657	2,5 - 6	MC3	0,560	1
211659	2,5 - 6	MC4	0,560	1

Crimping pliers HUPstar Photovoltaik

for photovoltaic connectors. Crimp pliers for industrial users, revolving precision impression dies with parallel feed, changeable dies.

Pressing star 213084/E

Photovoltaik: Amphenol Helios H4: 2,5 / 4 / 6, Multi-Contact MC3: 2,5 / 4 / 6, Multi-Contact MC4: 2,5 / 4 / 6, Tyco Solarlok: 1,5 / 2,5 / 4 / 6



Art. no.	TL	mm ²	kg	PU
213084	230	1,5 - 6	0,650	1

Crimpset „MULTI Photovoltaik“

Innovative crimping tool with rapid change system - one tool for almost all crimping applications

Contents of set: Crimping plier Multi (211962)

Crimping dies for „Multi - Contact“ connectors MC3

2,5 + 4 + 6 mm², AWG 13/11/10

Crimping dies for „Multi - Contact“ connectors MC4

2,5 + 4 + 6 mm², AWG 13/11/10

Other advantages:

- Screw less fast change system for crimping dies
- Single hand operation with expenditure energy
- With ratchet and built-in safety release, guarantees proper electrical connection
- Adjustable crimp pressure
- Chrome plated tool frame
- Additional purchase of other crimping dies possible
- Handy box protects pliers and dies



Art. no.	width	height	Tiefe	kg	PU
212005	260	40	200	1,150	1



HAUPA Crimp System for Photovoltaics

Crimp System Pliers for Photovoltaics

The basic hardware of the carrying case consists of:

- one pair of pliers, chromium-plated without crimping pliers insert
- one allen wrench (A/F 2.5 mm)
- one open-jawed wrench (A/F 7)
- 2 pieces spare screws (M4 x 10/M4 x 16 mm)

Specificationen:

- Special crimping pliers for crimping solar contacts of almost all types of connector systems
- Guaranteed exact, solder-free, electric connections
- Parallel closing of the crimping dies
- 30 % reduction of hand force through optimized leverage
- Forced latching for reliable crimping, releasable
- Crimp pressure adjustable
- Long lever arm allowing single-hand and two-hand control
- Easy change of the crimping pliers inserts, Locator fitting option for the determination of the connector position
- Several crimping positions in one crimp die assembly
- Design: chromium-plated with black plastic handle
- Material: specially heat-treated special steel



Art. no.	mm ²		kg	PU
212200	6	6 pcs.	0,998	1

Crimp inserts for "Huber & Suhner" contacts

212206	2,5 + 4 mm ² , AWG 13/11	1
212208	4 + 6 mm ² , AWG 13/11	1

Crimp inserts for "multi-contact" contacts

212210	MC3, 2,5 + 4 + 6 mm ² , AWG 13/11/10	1
212212	MC3, Locator	1

Crimp inserts for "multi-contact" contacts

212214	MC4, 2,5 + 4 + 6 mm ² , AWG 13/11/10	1
212216	MC4, Locator	1

Crimp insert for "Hirschmann" contacts

212218	2,5 + 4 + 6 mm ² , AWG 13/11/10	1
--------	--	---

Crimp insert for "Tyco" contacts

212220	Tyco 1,5 + 2,5 + 4 + 6 mm ²	1
212222	Locator for Tyco	1

Dies for Solar contacts Amphenol

212226	2,5 + 4 mm ² , AWG 13/11	1
212228	2,5 + 4 mm ² , AWG 13/11	1

haupa

... convincing solutions

INFO

Crimping pliers for end sleeves

When crimping end sleeves a distinction is made between sleeves with and without plastic collars and between trapezoid, square and hexagon pressing.

The sleeves with a plastic collar make it easier to insert individual stranded wires. The coloured marking on the wire end sleeves is used to classify the cross section.

Pliers with a square crimp ensure better contact in the terminal strip. The square crimp also facilitates alignment and assembly, as clamps can be attached to each of the surfaces.

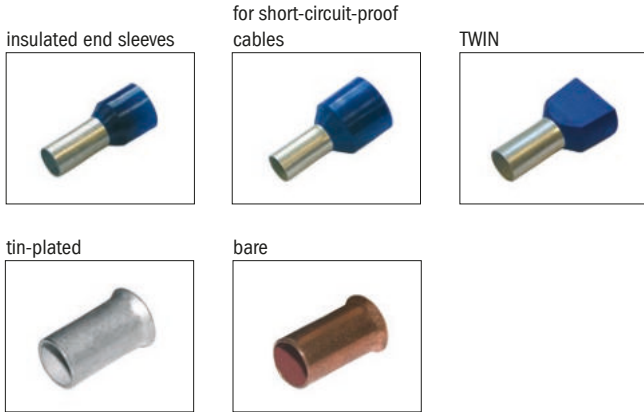

Crimping pliers

for end sleeves, with cutting and stripping mechanism, black



Art. no.	TL	mm ²	kg	PU
210818	165	0,25 - 2,5	0,210	1

Crimping pliers

for end sleeves, with cutting and stripping mechanism, matt, chrome-plated



Art. no.	TL	mm ²	kg	PU
210820 *	140	0,25 - 2,5	0,202	1
210824 *	220	0,75 - 16	0,304	1
210826 *	225	10 - 35	0,277	1

Crimping pliers

for end sleeves, short construction, 20% angled handy form, with locking device, with adjustable crimp pressure, **trapezoid pressing**



Art. no.	mm ²	kg	PU
211650	0,14 - 2,5	0,371	1
210841	0,25 - 6	0,380	1
211652	6 - 16	0,374	1

Crimping pliers for twin end sleeves

with locking device, with adjustable crimp pressure, chrome plated, **trapezoid pressing**



Art. no.	mm ²	kg	PU
211676	0,5 - 6	0,576	1
211678	6 - 16	0,604	1

Crimping pliers

for end sleeves, with locking device, with adjustable crimp pressure, chrome plated, **trapezoid pressing**



Art. no.	mm ²	kg	PU
210763 *	0,5 - 4	0,578	1
210842 *	1 - 10	0,553	1
210765	6 - 16	0,582	1
211672	10 - 25	0,580	1
210768	10 - 35	0,606	1
211674	25 - 50	0,600	1

HUPcompact „HC02“

for end sleeves, 100% parallel crimp, precision crimp, handle force: 5 kN, small compact construction, life span: 50,000 crimp cycles, **trapezoidal pressing**, (10 + 16 mm² wave profile/ 0.5-6 mm² trapezoidal profile)



Art. no.	∅	kg	PU
213088	0,25 - 16	0,480	1

Crimping pliers

for end sleeves, precise **square pressing** profile, automatic setting to the conductor cross-section, unlockable forced lock, guarantees connections that meet DIN, high transmission and ergonomically shaped plastic handles for fatigue free working, **square pressing**,

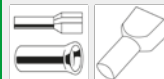

2 grooved and 2 smooth jaws for better insertion of the sleeve.

Art. no.	mm ²	Twin (mm ²)	kg	PU
210804	0,08 - 10	square 2 x 4	0,413	1

Crimping pliers

for end sleeves, precise crimping profile, automatic setting to the conductor cross-section, unlockable forced lock, guarantees connections that meet DIN, high transmission and ergonomically shaped plastic handles for fatigue free working, **square pressing**

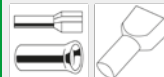

Art. no.	mm ²	Twin (mm ²)	kg	PU
211816 *	0,08 - 16	square 2 x 4	0,413	1

Crimping pliers for end sleeves

Crimpzange HUPsquare 10

for end sleeves, precise square pressing profile, automatic setting to the conductor cross-section, unlockable forced lock, guarantees connections that meet DIN, high transmission and ergonomically shaped plastic handles for fatigue free working, **square pressing**

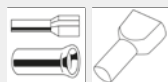

Art. no.	mm ²	Twin (mm ²)	kg	PU
212804	0,08 - 10	square 2 x 4	0,413	1

Crimpzange HUPsquare 16

for end sleeves, precise square pressing profile, automatic setting to the conductor cross-section, unlockable forced lock, guarantees connections that meet DIN, high transmission and ergonomically shaped plastic handles for fatigue free working, **square pressing**

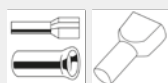

Art. no.	mm ²	Twin (mm ²)	kg	PU
212806	0,5 - 16	square 2 x 4	0,413	1

Crimping pliers

for end sleeves, precise hexagonal crimping profile, automatic setting to the conductor cross-section, unlockable forced lock, guarantees connections that meet DIN, high transmission and ergonomically shaped plastic handles for fatigue free working, **hexagon pressing**

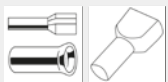

Art. no.	mm ²	Twin (mm ²)	kg	PU
211805	0,08 - 6	sechskant 2 x 2,5	0,413	1

Crimping pliers

for end sleeves, precise crimping profile, automatic setting to the conductor cross-section, unlockable forced lock, guarantees connections that meet DIN, high transmission and ergonomically shaped plastic handles for fatigue free working, **hexagon pressing**

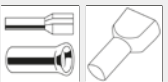

Art. no.	mm ²	Twin (mm ²)	kg	PU
211818	0,08 - 10	sechskant 2 x 4	0,413	1

Front-Crimping pliers

for end sleeves, precise **square pressing** profile, automatic adjustment on wire diameter, frontal approach allows working in small areas, sidewise approach for end sleeves up to 2.5 mm², with locking device, high transmission and ergonomically formed plastic handle, **square pressing**

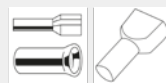

Art. no.	mm ²	Twin (mm ²)	kg	PU
210819	0,08 - 10	square 2 x 4	0,489	1
211810	0,08 - 16	square 2 x 6	0,489	1

Front-Crimping pliers

for end sleeves, automatic adjustment of crimp-profile, with locking device, with adjustable crimp pressure, **trapezoid pressing**

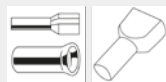

Art. no.	mm ²	Twin (mm ²)	kg	PU
210979	0,14 - 6	2 x 4	0,575	1
210979/B	10 - 16	2 x 6	0,584	1

Crimping pliers

for end sleeves, lever translated version for better transmission of force, with unlockable locking mechanism, with wave profile, also suited for thinned, compacted conductors, **trapezoidal pressing**

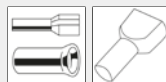

Art. no.	mm ²	Twin (mm ²)	kg	PU
210788 *	10 - 50	2 x 16	0,732	1
210789	50 - 95	-	0,800	1

Quadro complete set in case

in case:
1 „Quadro“-pliers incl. magazine
2 spare magazines



Art. no.	TL	mm ²	kg	PU
210682	170	0,5 - 2,5	0,713	1

haupa

... convincing solutions

Pneumatic crimpers

HAUPA Pneumatic Crimpers

for end sleeves, pneumatic crimpers crimp wire end sleeves quickly and without effort. Table top versions are actuated by a foot switch, allowing the operator to use both hands. The Pneumatic Crimpers are lightweight and easy to use. The crimping mechanism is easily activated, making it perfectly suited for work in control cabinets and electrical equipment. These tools are maintenance free - they require no routine calibration - only 60 - 90 psi to allow proper operation. Incl. spiral hose 2 m

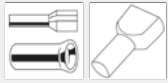

Video 217010-40



Art. no.	TL	mm ²	kg	PU
217030	200	0,25 - 2,5	0,720	1
217040	200	4 - 10	0,739	1

HAUPA Pneumatic crimpers table top versions

for end sleeves, table top versions are actuated by a foot switch, allowing the operator to use both hands. Incl. spiral hose, foot switch and table clamp

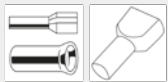

Art. no.	TL	mm ²	kg	PU
217010	200	0,25 - 2,5	5,000	1
217020	200	4 - 10	5,000	1



haupa®

MADE IN GERMANY

2 0804

Crimping pliers for insulated crimp cable lugs

INFO

Crimping pliers for insulated crimp cable lugs

Insulated cable lugs and crimp cable lugs are crimped in an oval form.

The coloured marking of the wire cross section to the insulated cable lug is defined in DIN 46245, Parts 1, 2 and 3.

- Red => stands for 0.5 to 1 mm²
- Blue => stands for >1.5 to 2.5 mm²
- Yellow => stands for >2.5 to 6 mm²

As the cable lug is rolled from a metal sheet, attention should be paid to the position of the butted edge. It should be in the middle of the top profile. If it is on the side, the edge opens up and the wire is not gastight or adequately clamped.

Butted edge



Ring terminals



Fork terminals



Shrinkable connectors



Round terminals



Flat terminals



Socket sleeves (female)



Round sleeves



Round pins



Socket sleeves (male)



Butt connectors



Parallel connectors

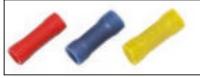

End connectors



Crimping pliers

for insulated crimp cable lugs, short construction, 20% angled handy form, with locking device, with adjustable crimp pressure, **oval pressing**



Art. no.	mm ²	kg	PU
210845	0,08 - 2,5	0,343	1

Crimping pliers

for insulated crimp cable lugs, with locking device, with adjustable crimp pressure, chrome plated, **oval pressing**



Art. no.	mm ²	kg	PU
210761 *	0,5 - 6	0,566	1

HUPcompact „HC01“

for insulated cable lugs and connectors, 100% parallel crimp, precision crimp, handle force: 5 kN, small compact construction, life span: 50,000 crimp cycles, **oval pressing**



Art. no.	∅	kg	PU
213090	0,1 - 6	0,578	1

Crimping pliers

for insulated crimp cable lugs, lever translated version for better transmission of force, with unlockable locking mechanism, **oval pressing**



Art. no.	mm ²	kg	PU
210827	10 - 16	0,472	1

Crimping pliers

for insulated crimp cable lugs with wire- and bolt-cutters and wire stripper with threaded bolt-cutter, **oval pressing**



Art. no.	mm ²	kg	PU
210802	1,5 - 6	0,178	1

Combi-Crimping pliers

for insulated and uninsulated crimp cable lugs and connectors from 0.5 - 6 mm², C 45, cutting edges induction hardened, with wire- and bolt-cutters and wire stripper with threaded bolt-cutter, **oval pressing**



Art. no.	mm ²	kg	PU
210808 *	1,5 - 6	0,198	1

Crimping pliers for shrink connectors

Crimping pliers

for shrink connectors, with locking device, with adjustable crimp pressure, chrome plated, **oval pressing**



Art. no.	mm ²	kg	PU
211695	0,5 - 10	0,566	1

Crimping pliers for coaxial connections

Crimping pliers

for coax-connections, short construction, 20% angled handy form, with locking device, with adjustable crimp pressure, **hexagon pressing**



Art. no.	Crimp	kg	PU
210849	RG 55-58-59-62	0,303	1

Crimping pliers

for coax-connections, with locking device, with adjustable crimp pressure, chrome plated, **hexagon pressing**



Art. no.	Crimp	kg	PU
210767 *	RG 55-58-59-62	0,567	1
211680	RG 55-58-59-62-5-6	0,578	1

Crimping pliers HUPstar Coax

for coaxial connectors. Crimp pliers for industrial users, revolving precision impression dies with parallel feed, changeable dies.

Pressing star 213082/E

Coax:

Hexagon crimp, BNC, TNC, SNB, SNC, SMS, SMA, MCX, 1.07 to 10.9 mm



Art. no.	TL	kg	PU
213082	230	0,650	1

Crimping pliers for contacts and connectors

INFO

Crimping pliers for contacts and connectors

D-Sub plugs are open plug-in connectors that are connected with the wire via a rolling crimp. D-Sub plugs are used in modern office and communication technology.

Rolled contacts are open plug-in connectors that are connected with the wire via a rolling crimp. It is important to choose the correct plug for the cross section of the wire. No single wire may project from the crimp.

Twisted contacts are used to connect computer interfaces, power and control wires in multi-pole plug-in connections and flexible assembly lines in the automotive industry.

Crimping pliers

short construction, for twisted contacts, 20% angled handy form, with locking device, with adjustable crimp pressure, **square pressing**



Art. no.	crimp	kg	PU
211656	0,14-4	0,367	1
211658	1,5-6	0,372	1

Crimping pliers

short construction, for rolled contacts, 20% angled handy form, with locking device



Art. no.	crimp	kg	PU
211660	0,5-1,5	0,370	1

Crimping pliers

short construction, for D-Sub-connectors, 20% angled handy form, with locking device



Art. no.	crimp	kg	PU
211662	0,08-0,5	0,365	1

haupa[®]

... convincing solutions

HAUPA GmbH & Co. KG, Koenigstr. 165-169, 42853 Remscheid, Phone: +49 (0)2191 8418-0, Fax: +49 (0)2191 8418-840, sales@haupa.com

Crimping pliers for uninsulated open brass cable lugs

INFO

Crimping pliers for uninsulated open brass cable lugs

We distinguish between wire crimps and insulation crimps. The end of the wire should be flush with the wire crimp or extend beyond it no further than 1 mm, so that the plug function is not affected. The insulation end must not project into the wire crimp, however it must also not lie just half beneath the insulation crimp. Only in this way can a standard-compliant crimp be ensured. In a good crimp the wire must be deformed. In this case one talks of a "gastight crimp".



Wrong:
The end of the insulation is in the insulation crimp.
Wrong:
The stripped wire projects into the contact zone.

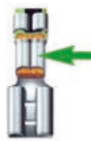
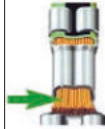

Correct:
The end of the insulation and the stripped wire are crimped accurately. To facilitate accurate crimping a positioning aid is available for crimping pliers.

Socket sleeves (female) with cable stop



bare brass

Socket sleeves (female) with cable stop and side cable connection



bare brass

Flat terminals

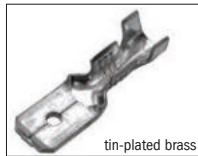

tin-plated brass

Precision-ground crimp profiles => clean crimp

Adjustable crimping pressure => Wear compensation via adjusting screw

Forced block, unblockable => guaranteed DIN-compliant crimped connection

Ergonomically formed plastic handles => low fatigue work

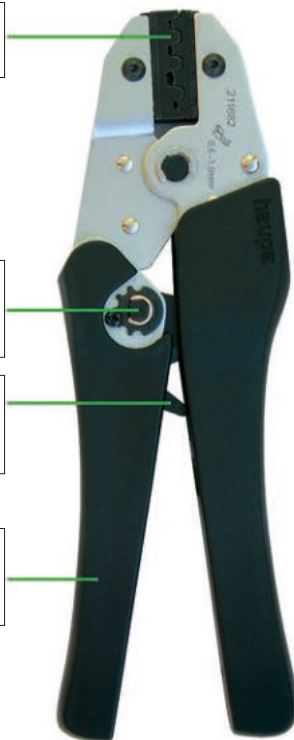

Crimping pliers

for open brass cable lugs, short construction, 20% angled handy form, with locking device, with adjustable crimp pressure, **roll pressing**



Art. no.	mm ²	kg	PU
210777	0,5 - 1,5	0,366	1

Crimping pliers

for open brass cable lugs, with locking device, with adjustable crimp pressure, chrome plated, **roll pressing**



Art. no.	mm ²	kg	PU
211682	0,5 - 2,5	0,568	1
210762 *	0,5 - 6	0,575	1

Crimping pliers

for open brass cable lugs, with locking device, with adjustable crimp pressure, chrome plated, **roll pressing**



Art. no.	mm ²	kg	PU
210785	0,05 - 1	0,537	1
210786	1,5 - 2,5	0,535	1

HUPcompact „HC04"

for open brass tab connectors, 100% parallel crimp, precision crimp, handle force: 5 kN, small compact construction, life span: 50,000 crimp cycles, with locator, **roll pressing**



Art. no.	∅	kg	PU
213094	0,5 - 6	0,490	1

Crimping pliers for uninsulated crimp cable lugs

INFO

Crimping pliers for uninsulated terminals

Important when crimping uninsulated terminals and butt space connectors: Uninsulated crimping terminals are pressed together by means of so-called piercing compression. The crimp sleeve is compressed in the middle. The pressing thorn should be set to the separating seam of the sleeve.

Crimping terminals
Ring type



Crimping terminals
Fork type



Crimping terminals
Pin type



Crimping terminals
Butt connectors



Crimping terminals
Parallel connectors



Crimping pliers

for non insulated crimp cable lugs, short construction, 20% angled handy form, with locking device, with adjustable crimp pressure, **mandrel shape pressing**



Art. no.	mm ²	kg	PU
210778	0,25 - 2,5	0,363	1
210779	0,5 - 6	0,366	1

Crimping pliers

for non insulated crimp cable lugs, with locking device, with adjustable crimp pressure, chrome plated, **mandrel shape pressing**



Art. no.	mm ²	kg	PU
210764	1,5 - 10	0,565	1

HUPcompact „HC03"

for non insulated cable lugs and connectors, 100% parallel crimp, precision crimp, handle force: 5 kN, small compact construction, life span: 50,000 crimp cycles, **mandrel shape pressing**

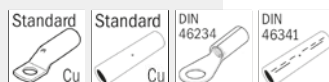

Art. no.	∅	kg	PU
213092	0,75 - 10	0,480	1

Crimping pliers

for non insulated crimp cable lugs, lever translated version for better transmission of force, with **mandrel pressing**, for standard tubular cable lugs and connectors. Particularly well suited to nickel tubular cable lugs and connectors

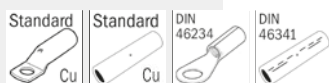

Ni



Art. no.	mm ²	kg	PU
210771	0,75-1-2,5-4-6	0,478	1

Crimping pliers

for non insulated crimp cable lugs, lever translated version for better transmission of force, with mandrel pressing, for standard tubular cable lugs and connectors. Particularly well suited to nickel tubular cable lugs and connectors



Ni



Art. no.	mm ²	kg	PU
210772	1-2,5-4 > 6-10	0,478	1
210774	1 > 2-6-10-16	0,503	1

Crimping pliers

for non insulated crimp cable lugs, lever translated version for better transmission of force, with mandrel pressing, for standard tubular cable lugs and connectors

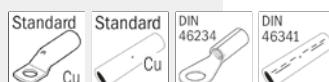

Art. no.	mm ²	kg	PU
210799	0,5 - 16	0,903	1

haupa[®]

... convincing solutions

INFO

Crimping pliers for uninsulated tubular cable lugs

1. Choosing the connector

To achieve a standard-compliant connection it is necessary to choose the correct connector for the application and the right cable cross section.

2. Stripping

Before notching, the cable must be stripped according to the insertion length (+10% due to change in length of the crimping sleeve).

3. Cleaning

The ends of the wire must be cleaned thoroughly to remove all traces of dirt and oxidation before being assembled.

4. Assembly

Insert the cable into the cable lug or connector to its full insertion length. Crimp the cable lug or connector with the correct tool, taking account of the crimping direction (see figure).

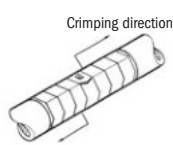
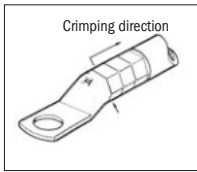

Tube cable lugs



Tin-plated copper

DIN cable lugs



Butt connectors, DIN



Tin-plated copper



with inspection



bare



bare

Crimping pliers

for non insulated crimp cable lugs, lever translated version for better transmission of force, with **mandrel pressing**, for standard tubular cable lugs and connectors. Particularly well suited to nickel tubular cable lugs and connectors



Art. no.	mm ²	kg	PU
210771	0,75-1-2,5-4-6	0,478	1

Crimping pliers

for non insulated crimp cable lugs, lever translated version for better transmission of force, with **mandrel pressing**, for standard tubular cable lugs and connectors. Particularly well suited to nickel tubular cable lugs and connectors

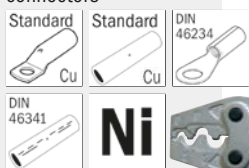

Art. no.	mm ²	kg	PU
210772	1-2,5-4 > 6-10	0,478	1
210774	1 > 2-6-10-16	0,503	1

Crimping pliers

Lever translated version for better transmission of force, with **mandrel pressing**, for standard tubular cable lugs and connectors. Particularly well suited to nickel tubular cable lugs and connectors

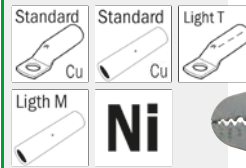

Art. no.	mm ²	kg	PU
210830 *	0,75 - 16	0,574	1

Crimping pliers

with punch and adjustable screw for different cross-sections, for standard tube terminals and connectors, **mandrel shape pressing**

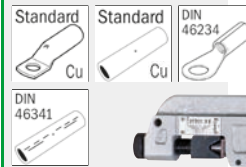

Art. no.	mm ²	kg	PU
210791	10 - 120	3,040	1

Crimping pliers

for uninsulated "Standard" tube terminals/connectors and tube terminals for fine-wire cables, with integrated rotatable profile disc, **mandrel shape pressing**, with telescopic grips, also suited for thinned, compacted conductors

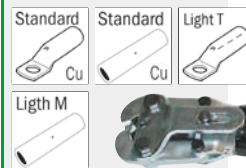

Art. no.	mm ²	kg	PU
210836	50 - 120	5,280	1
210838	120 - 240	5,200	1
210840	185 - 400	5,200	1

Crimping pliers

with built-in rotatable profile disk, **hexagon pressing**

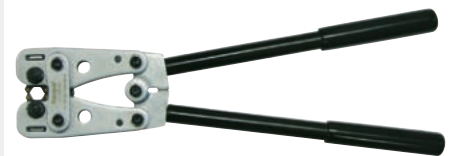
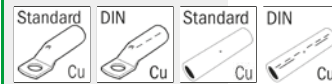

Art. no.	mm ²	kg	PU
210805 *	6 - 50	1,351	1
210805 K *	6 - 50	1,352	1
210850 *	10 - 120	3,970	1
210853 *	10 - 120	4,016	1

Crimping pliers for modular plugs

INFO

Crimping pliers for modular plugs

Stripping and crimping in one step. The following distinctions can be made between Western plugs:

- 4pole plug for telephone, power supply
- 6pole plug for fax and telephone connection
- 8pole plug for ISDN and PC connections

Crimping pliers for modular plugs

for unshielded modular plugs, inexpensive, lightweight tool for the casual usage



Art. no.	crimp	kg	PU
210867	RJ10 4(4), RJ14	0,218	1
210865	RJ11 6(4), RJ12 6(4)	0,220	1
210869	RJ45	0,233	1

Crimping pliers for modular plugs

for unshielded modular plugs, with cable cutter and stripper, light construction (6p, 8p, 6DEC, 4p)



Art. no.	crimp	kg	PU
213050	RJ11 6(4), RJ12 6(4), RJ45, RJ10 4(4), RJ14	0,300	1

Crimping pliers for modular plugs

for unshielded modular plugs, with cable cutter and stripper. Exactly crimp process through parallel crimping, even crimping quality by means of safety catch



Art. no.	crimp	kg	PU
210857	RJ11, RJ12 6(4), RJ45	0,471	1

Crimping pliers for modular plugs

for unshielded modular plugs 4-,6- and 8pole plug, 6DEC, heavy construction, with linear stroke and locking device, with cable cutter and stripper. Exactly crimp process through parallel crimping, even crimping quality by means of safety catch



Art. no.	crimp	kg	PU
210871	RJ11 6(4), RJ12 6(4), RJ45, RJ10 4(4), RJ14	0,520	1

Crimping pliers for modular plugs

Semi-professional crimping pliers for shielded and unshielded Western plugs, with replaceable crimping dies, easy to use, light on the arms due to optimum leverage, optimum crimping, pliers body made of hardened quality steel, quick and simple replacement of crimping dies, adjustable crimping pressure and depth, application area for small and medium series, 50.000 working processes guaranteed, without dies



Art. no.	kg	PU
213000	0,420	1

Dies

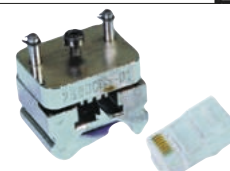

Art. no.	crimp	kg	PU
213002	RJ10 4(4)	0,082	1
213004	RJ11 6(4), RJ12 6(4)	0,081	1
213006	6DEC	0,080	1
213008	8 pole, unshielded RJ45	0,076	1
213010	10 pole, unshielded RJ50	0,074	1
213012	8pole, shielded	0,076	1
213014	10pole plug, shielded	0,071	1



213000

haupa[®]

... convincing solutions

HAUPA GmbH & Co. KG, Koenigstr. 165-169, 42853 Remscheid, Phone: +49 (0)2191 8418-0, Fax: +49 (0)2191 8418-840, sales@haupa.com

Crimping pliers for modular plugs



Professional crimping pliers for screened and unscreened Western plugs, with replaceable crimping dies, easy to use, light on the arms due to optimum leverage, optimum crimping, pliers body made of hardened quality steel, quick and simple replacement of crimping dies, adjustable crimping pressure and depth, application area for medium to large series, 50.000 working processes guaranteed, without dies



Art. no.	kg	PU
213020	0,474	1

Network range

Case with insert. With tools for cable stripping, cutting, crimping and applying to strips, sockets or fields.

Content:

- 1 crimping pliers for Western plugs (213050)
- 1 wire stripper for UTP/STP data cable (200068)
- 1 Sensor input tool LSA for UTP and STP cable (300322)



Art. no.	kg	PU
300033	0,700	1

Dies



for crimping pliers 213020



Art. no.	crimp	kg	PU
213022	8pole, shielded	0,103	1
213024	10pole, shielded	0,102	1
213026	RJ10 4(4)	0,096	1
213028	RJ11 6(4), RJ12 6(4)	0,093	1
213030	6DEC	0,091	1
213032	RJ45	0,106	1
213034	RJ50	0,102	1
213036	8pole, CAT 5	0,106	1
213038	6pole, shielded	0,106	1
213040	8pole, shielded	0,113	1
213042	Ø 3,7 mm	0,030	1
213044	Ø 4,5 mm	0,030	1
213046	Ø 5,2 mm	0,030	1
213048	Ø 6,0 mm	0,030	1



213000



213020

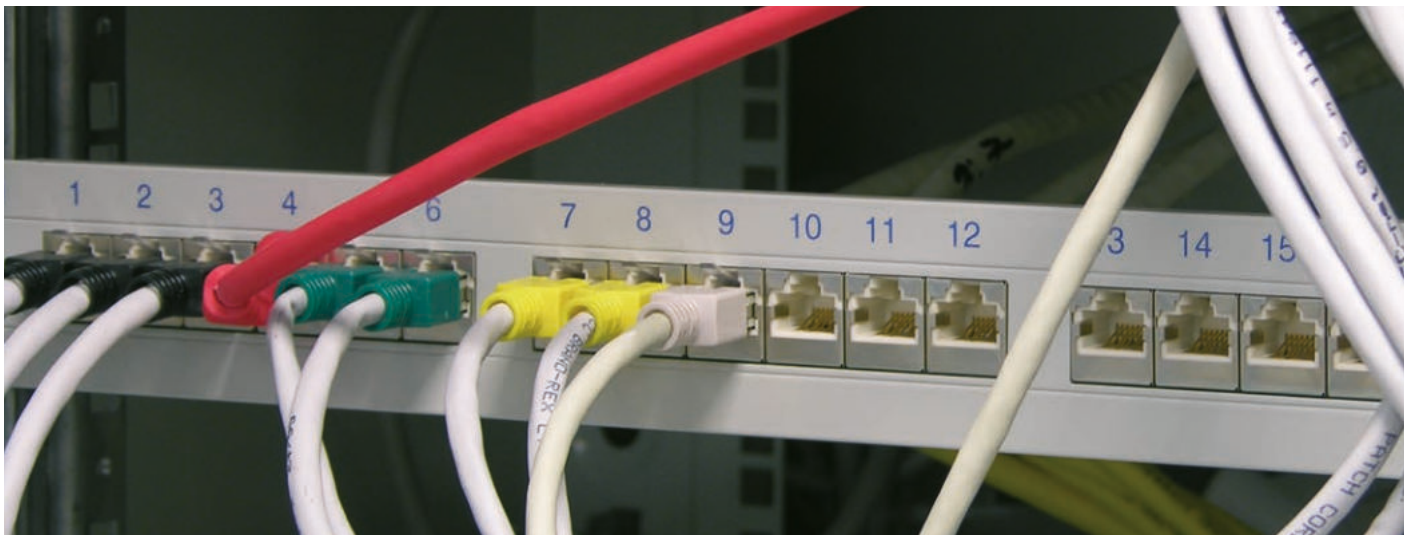

Multi-functional pliers



INFO

Crimp stars for open and closed tool frames

Crimping pliers HUPstar from HAUPA

When it comes to high-end crimping technology for professional, industrial users, with the HUPstar HAUPA has succeeded in introducing a range which uses 3 different frame types to handle all common connection pressings simply by quickly and reliably replace the relevant star. Thus making it the ideal complete tool for your tool case and in the workshop.

7 versions of HUPstar are already permanent components of the range:

1. End sleeves

Insulated crimp-style cable lugs

Ring cable lugs (DIN 46234 / DIN 46341)

2. End sleeves 0.14 – 16 mm²

Open brass cable lugs

3. Coaxial:

4. Photovoltaics / Solar

5. Fibre Optic Connector

6. Twisted contacts, square

7. Automotive contacts

The star can be changed in just 30 seconds!

The colour code on the stars enables fast and correct assignment.

The extremely precise parallel feed and the eroded precision crimp profile mean that this product has been very well received by the industry. Not just thanks to the high quality processing of the crimp star which is, thanks to the surface properties for around 80,000 precision crimps.

After all a precise and safe normed crimp is the guarantee for complication-free, high quality and long-lasting connections.

Ergonomically, the HUPstar can, thanks to the short construction of the handles and the rather small opening angle, also be operated quickly, safely and gentle to joints even with small hands.

Due to the innovative manufacturing procedure, individual stars, designed for industrial customers, can also be made without additional costs.

Video HUPstar



Tool frame „HUPstar” – open

Tool frame without star crimp, open design specifically for connectors



Art. no.	TL	kg	PU
213078	230	0,510	1

Tool frame „HUPstar” – closed

Tool frame without star crimp, closed-frame design



Art. no.	TL	kg	PU
213077	230	0,510	1

Crimping pliers „HUPstar”



Pressing star 213086/E:

End sleeves: 0,5 / 0,75 / 1,5 / 2,5 / 4 / 6 / 10

Insulated crimp cable lugs:

0.1-0.25 / 0.5-1 / 1.5 / 2.5 / 4 / 6

Non-insulated crimp cable lugs:

0.25 / 0.5 / 1 / 1.5 / 2.5 / 4 / 6 / 10



Art. no.	TL	kg	PU
213086	230	0,650	1

Crimping pliers „HUPstar”



Pressing star 213080/E:

End sleeves:

0.14-0.25 / 0.25-0.5 / 1 / 1.5 / 2.5 / 4 / 6 / 10 / 16

Open non-insulated brass cable lugs:

0.14-0.25 / 0.25-0.5 / 1 / 1.5 / 2.5 / 4 / 6

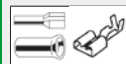

Art. no.	TL	kg	PU
213080	230	0,650	1

213086/E			213080/E		213082/E	213098/E	213102/E
						Fibre Optik	
0,5	0,1-0,25	0,25	0,14-0,25	0,14-0,25	1,07		0,1
0,75	0,5-1,0	0,5	0,25-0,5	0,25-0,5	1,2	1,69	0,14
1,5	1,5	1,0	0,75	0,75	1,46	3,0	0,25
2,5	2,5	1,5	1,0	1,0	1,69	3,25	0,34
4,0	4,0	2,5	1,5	1,5	1,72	4,2	0,5
6,0	6,0	4,0	2,5	2,5	1,75	4,52	1,0
10,0	-	6,0	4,0	2,54	2,54	4,95	1,5
-	-	10,0	6,0	6,0	3,25	5,0	2,5
			10,0	-	6,48	6,5	4,0
			16,0	-	7,0	10,9	6,0
					8,1		10
					8,23		Lokator für
					9,73		ø 1,6
					10,9		ø 2,5
							ø 4,0

213084/E - Photovoltaic			
Amphenol	Multi Contact	Multi Contact	Tyco
2,5	2,5	2,5	1,5
2,5	2,5	2,5	1,5
6,0	6,0	6,0	4,6

Dies for HUPstar

Crimping pliers HUPstar Coax



Pressing star 213082/E

Coax:

Hexagon pressure bonding, BNC, TNC, SNB, SNC, SMS, SMA, MCX, 1.07 to 10.9 mm



Art. no.	TL	kg	PU
213082	230	0,650	1

Crimping pliers HUPstar Photovoltaic



Pressing star 213084/E

Photovoltaics:

Amphenol Helios H4: 2,5 / 4 / 6

Multi-Contact MC3: 2,5 / 4 / 6

Multi-Contact MC4: 2,5 / 4 / 6

Tyco Solarlok: 1,5 / 2,5 / 4 / 6



Art. no.	TL	kg	PU
213084	230	0,650	1

HUPstar „Fibre Optic Connector“



Fiber Optic Connector

1.69; 2.5; 3; 3.25; 3.65; 4.2; 4.52; 4.95; 5; 6.5; 10.9



Art. no.	TL	kg	PU
213098	230	0,650	1

HUPstar „Twisted contacts“



Twisted contacts, square

0,1; 0,14; 0,25; 0,34; 0,5 1; 1,5; 2,5; 4; 6; 10

Locator for Ø 1,6; 2,5; 4



Art. no.	TL	kg	PU
213102	230	0,650	1

HUPstar „Automotive“



Automotive contacts

Hirose DF1B-2428SC UL1007 / Litz wire

Hirose DF1B-2428PC UL1007 / Litz wire 0,08; 0,14; 0,25

Hirose DF1B-30SC UL1007 / Litz wire

Hirose DF1B-30PC UL1007 / Litz wire 0,05

Hirose DF1B-2022SC, Hirose DF1B-2022PC 0,34; 0,50



Art. no.	TL	kg	PU
213100	230	0,650	1

HUPstar



End sleeves 0.5 - 10 mm²

Insulated cable lugs 0.25 - 6 mm²

Ring cable lugs (DIN 46234 / DIN 46341) 0.75 - 10 mm²



Art. no.	dies	kg	PU
213086/E		0,160	1

HUPstar



End sleeves 0,25 - 16 mm²

Socket sleeves 0,25 - 6 mm²



Art. no.	dies	kg	PU
213080/E		0,160	1

HUPstar „Coaxial“



Coaxial

BNC, TNC, SNB, SNC, SMS, SMA, MCX, 1.07 - 10.9 mm



Art. no.	dies	kg	PU
213082/E		0,160	1

HUPstar „Photovoltaic“



for art. 213077

Photovoltaics / Solar

Amphenol Helios H4 2.5 - 6, multi-contact MC3/ MC4 2.5 - 6.0

Tyco Solarlok, 1.5 - 6 mm²



Art. no.	dies	mm ²	kg	PU
213084/E		1,5 - 6	0,160	1

HUPstar „Fibre Optic Connector“



Fibre Optic Connector

1.62; 2.5; 3; 3.25; 3.65; 4.2; 4.52; 4.95; 5; 6.5; 10.9



Art. no.	dies	kg	PU
213098/E		0,170	1

HUPstar „Twisted contacts, square“



for frame Art. no. 213077

Twisted contacts, square

0,1; 0,14; 0,25; 0,34; 0,5 1; 1,5; 2,5; 4; 6; 10

Locator for Ø 1,6; 2,5; 4



Art. no.	dies	kg	PU
213102/E		0,170	1

haupa[®]

... convincing solutions

Multi-function pliers

Crimping pliers Combi-Crimp

crimping pliers for insulated terminals 0,5 - 2,5 mm² and end sleeves 0,5 - 6 mm²

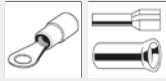

Art. no.	mm ²	kg	PU
210784 *	0,5 - 6,0	0,560	1

Crimpset X-Crimp including nylon bag

Crimping pliers used to quickly change HAUPA precision pressing inserts. Supplied in robust nylon bag (article 220260).

- Reliable crimping results just like with fixed pressing inserts
- Forced lock ensures standardised pressing actions
- Flat construction enables you to work precisely even when space is at a premium



Content:

Art. 211690
Art. 210763/E
Art. 210764/E
Art. 210765/E
Art. 210761/E



Art. no.		kg	PU
211692 *	set	0,900	1
220260	bag	0,060	1

Crimpset X-Crimp Photovoltaics

Crimping pliers for quick change of HAUPA precision crimping dies especially for photovoltaics. Delivery in robust nylon bag (Art. 220260).



Inhalt:

Art. 211690
Art. 211657/E
Art. 211659/E
Art. 210842/E
Art. 210761/E



Art. no.		kg	PU
211697	set PV	0,900	1

Crimping pliers X-Crimp

Crimping pliers used to quickly change HAUPA precision pressing inserts, including dies article 210761/E.

- Reliable crimping results just like with fixed pressing inserts
- Forced lock ensures standardised pressing actions
- Flat construction enables you to work precisely even when space is at a premium



Art. no.		kg	PU
211690	210761/E	0,566	1

Crimping dies for insulated crimp cable lugs

for insulated crimp cable lugs, oval pressing



Art. no.	mm ²	kg	PU
210761/E	0,5 - 6,0	0,053	1

Crimping dies for uninsulated terminals

for uninsulated terminals, mandrel shape pressing



M
210

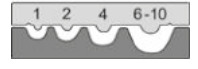

Art. no.	mm ²	kg	PU
210764/E	1 - 10	0,111	1

Crimping dies for end sleeves

for end sleeves, trapezoid pressing



M
210



Art. no.	mm ²	kg	PU
210763/E	0,5 - 4	0,072	1
210842/E	1 - 10	0,054	1
210765/E	6 - 16	0,111	1
211672/E	10 - 25	0,050	1

Crimping dies for TWIN end sleeves

for TWIN-end sleeves, trapezoid pressing



M
210



Art. no.	mm ²	kg	PU
211676/E	0,5 - 6	0,050	1

Crimping dies for coaxial cable

for coaxial cable, hexagon pressing



M
210

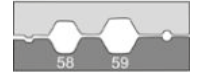

Art. no.	crimp	kg	PU
210767/E	RG 58-59-62-6	0,050	1

Crimping dies for flat connectors

for flat connectors, uninsulated open brass cable lugs, roll pressing



M
210



Art. no.	mm ²	kg	PU
210762/E	0,5 - 6	0,111	1

Crimping dies for Photovoltaik MC3

for „multi-contact“ contacts



M
210

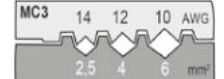

Art. no.	mm ²	kg	PU
211657/E	2,5 - 6 MC3	0,050	1

Crimping dies for Photovoltaik MC4

for „multi-contact“ contacts



M
210



Art. no.	mm ²	kg	PU
211659/E	2,5 - 6 MC4	0,050	1

Crimping dies for cable lugs / end sleeves

for end sleeves 0,5 - 6 mm² / cable lugs 0,5 - 2,5 mm²



M
210



Art. no.	mm ²	kg	PU
210784/E	0,5 - 6,0	0,56	1

Multi-function pliers

Crimpset MULTI

Innovative crimping tool with rapid change system for the expert - tools for almost all crimping applications

Contents:

- crimping plier MULTI

Dies for:

- (211998) insulated terminals 0.5 - 6 mm²
- (211963) insulated and uninsulated end sleeves 0.5 - 16 mm²
- (211999) uninsulated terminals 0.5 - 10 mm²
- (210000) dies for BNC and TNC coaxial connectors RG 58-59-62-71

Product specifications

- fast change system • easy changing of crimp dies by means of thumb screws
- easy interlock • Nickel plated surface
- no big strength required
- with ratchet and built-in safety release, guarantees proper electrical connection
- adjustable crimp pressure
- Pliers body from 3 mm, specially compensated, hardened sheet steel
- ergonomic 2 component handle with soft synthetic material insert



Art. no.	width	height	depth	kg	PU
211960	260	40	200	1,119	1

Crimping pliers „Multi“

Long version, also suitable for two-handed operation, no dies



Art. no.	kg	PU
211962	0,582	1

More possibilities of dies - please, order separately

211963	End sleeves 0,5 - 16 mm ²	1
211964	End sleeves 16 - 35 mm ²	1
211965	Sockets 0.5 - 2.5 mm ²	1
211990	Coax, Thinnet, Mini-UHF, BNC/TNC RG 58, RG 174	1
211991	Coax, BNC/TNC RG 174, RG 179, small coaxial connectors	1
211992	SMA, SMB, Mini-59, Mini-UHF, BNC/TNC RG 6, RG 6 Quad	1
211993	Coax, CATV "F" Typ, BNC/TNC RG 6, RG 6 Quad	1
211994	N-Typ RG 8, RG 11	1
211995	Coax, N-Typ RG 8, RG 11, RG 213, RG 216	1
211996	Fibre Optic, SMA Typ	1
211997	Fibre Optic, SMA, SMB, SFR, ST, SC Typ	1
211968	RJ 45 - 8P8K, Steward Connectors, 22-24 AWG	1
211969	RJ 11, RJ 12 - 6P6K, Steward Connectors, 22-24 AWG	1
211970	Telefon 4P4K, AMP+Steward Connectors, 22-24 AWG	1
211971	RJ 45 - 8P8K, AMP, 22-24 AWG	1
211972	RJ 11, RJ 12 - 6P6C, AMP, 22-24 AWG	1
211973	RJ 11, DEC MMJ - 6P6K, AMP, 22-24 AWG	1
211974	RJ 50 - 10P10K, AMP, 22-24 AWG	1
211980	RJ 45 - 8P8K, short, Steward Connectors, STP 22-24 AWG	1
211981	RJ 45 - 8P8K, long, Hirose, STP 22-24 AWG	1
211982	RJ 45 - 8P8K, short, Hirose, STP 22-24 AWG	1
211985	RJ 45 - 8P8K, AMP, Molex, for Ø 6.0 mm, STP 22-24 AWG	1
211998	insulated terminals 0,5-6,0 mm ²	1
211999	uninsulated terminals 0,5-6,0 mm ²	1
212000	Coax RG58-59-62-71	1
212007	MC3	1
212008	MC4	1

Elektric crimper

HAUPA electric crimper

The Electric crimper is an ideal device to securely crimp wires and cable terminals such as:

- insulated cable lugs to 6 mm²/10 AWG
- Tubular cable lugs, solderl. terminals to 10 mm²/8 AWG
- Flat tab terminals to 6 mm²/10 AWG
- Wire end sleeves to 50 mm²/1 AWG

The Electric Crimper can be operated in one of two modes:

Mode 1: controls the entire crimp process by pressing down the pedal switch.

Mode 2: allows the user to fix the terminal on the cable by actuating the foot switch once. To finish the crimping process, he presses down the foot switch once again. Mode 2 is used for more complex terminals.

The onset of compression force can be adjusted for each new terminal to satisfy crimp integrity. That way, damage to dies and terminals can be minimised.

Simply press a button to select the opening for each die. Since some female terminals are more difficult to crimp, a moveable locator can be utilised to ensure proper crimping. Various standard dies are available, as well as dies designed to customer specifications.

Technical Data Art. No. 217050: Dimensions (w x h x d): 140 x 220 x 320 mm
Weight: 10 kg / Weight of foot pedal: 1.2 kg / Max. press capacity: 10 kN
Pressing time: 1 s / Counter: -digit LCD display /
Mains connection: 30 V/50 Hz (120 V/60 Hz) / Power consumption: 160 VA



Art. no.	mm ²	kg	PU
217050	6 - 50	10,000	1

Dies for elektro crimper 217050

217052	Rolled contacts 0.14-1/1,5/2.5/4 mm ²	1
217056	Rolled contacts 0.1-1.5 mm ²	1
217058	Rolled crimp contacts 0.1-1.5 mm ²	1
217060	Rolled crimp contacts 0.5-6 mm ²	1
217062	End sleeves 0.25-6 mm ²	1
217064	Insolated terminals 0.5-6 mm ² symetric	1
217066	Insolated terminals 0.5-6 mm ² asymmetric	1
217068	Tube terminals 0.34-2.5 mm ²	1
217070	Tube terminals "super flex" 4-10 mm ²	1
217072	Tube terminals "standard" 4-10 mm ²	1
217074	Crimping terminals 4-10 mm ²	1
217076	Crimping terminals 0.5-10 mm ²	1
217078	Protection cover to 21 70 56, 21 70 60	1
217080	Protection cover to 21 70 70, 21 70 72, 21 70 74, 21 70 76	1
217082	Protection cover to 21 70 68	1
217084	Protection cover to 21 70 62	1
217086	Protection cover to 21 70 64, 21 70 66	1
217088	Locator to 21 70 60, socket sleeves 6.3 mm	1
217090	Locator to 21 70 56, 21 70 58, 21 70 60, socket sleeves 4.8 mm	1
217092	Locator to 21 70 56, socket sleeves (female) 2.8 x 5 mm	1
217094	Locator to 21 70 56, socket sleeves (female) 2.8 x 6 mm	1
217096	Locator to 21 70 60, socket (male) 6.3 mm	1
217098	Locator to 21 70 60, socket (male) 6.3 mm HN	1

haupa®

... convincing solutions

INFO

Mechanical crimping pliers for tubular cable lugs

Mechanical crimping tool characterised by its compact design. It is possible to make crimps even in confined working conditions, where conventional large tools cannot be used.

The mature construction of the drive has proven its reliability many times over in practice. In this manual crimping tool very little wear can be seen even after many years of use, this is decisive for the reliable repetition of the required crimping depth. After all, today's highly stressed crimped connections only comply with safety regulations when the required electrical and mechanical values are achieved over long periods.

Another safety aspect is that the crimping tool can only be detached from the crimped lug when the required crimping depth has been reached. By turning the wheel on the handle in an anti-clockwise direction the crimping inset can be set in position on the lug. Only then does the actual crimping process begin with the one-hand lever.

The quality of the crimped connection is dependent on the choice of cable lug, the crimp inset and the correct choice of cable cross section.

Crimping pliers

one hand precise tool, with ratchet and built-in-force-blocking device, crimping pressure 20 kN, interchangeable dies, easy to remove from the crimped lug by opening the crimping head, special small design for working in small areas



Product-specific features

- outstanding manageability
- compact construction
- precision drive
- fast forward feed
- can be used anywhere

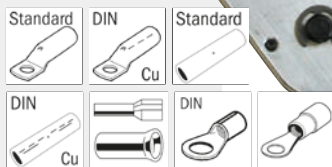

Art. no.	mm ²	kg	PU
215000	6 - 50	1,531	1

Metal box

for storing of crimping pliers and dies



Art. no.	kg	PU
215002	0,934	1

Crimping dies

for standard cable lugs and compacted cables, suitable for compacted cables,

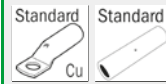

WM pressing



Art. no.	mm ²	kg	PU
215004	10	0,041	1
215006	16	0,040	1
215008	25	0,037	1
215010	35	0,036	1
215012	50	0,033	1

Crimping dies

noninsulated crimping terminals, **mandrel shape pressing**, DIN 46234



Art. no.	mm ²	kg	PU
215014	6	0,018	1
215016	10	0,190	1
215018	16	0,190	1
215020	25	0,190	1
215022	35	0,020	1
215024	6 - 35	0,020	1

Crimping dies

noninsulated crimping terminals, **mandrel shape pressing**, DIN 46234



Art. no.	mm ²	kg	PU
215026	10	0,039	1
215028	16	0,039	1

Crimping dies

for crimping terminals DIN, **hexagon pressing**



Art. no.	Cu	Al	KZ	kg	PU
215030	6	-	5	0,100	1
215032	10	-	6	0,100	1
215034	16	10	8	0,100	1
215036	25 - 25	16	10	0,150	1
215038	35 - 35	25	12	0,150	1
215040	50 - 50	35	14	0,150	1

Crimping dies

for end sleeves, **trapezoid pressing**



Art. no.	mm ²	kg	PU
215042	6	0,150	1
215044	10	0,150	1
215046	16	0,150	1
215048	25	0,200	1
215050	35	0,200	1

INFO

Mechanical crimping pliers for tubular cable lugs

These mechanical manual crimping pliers are modern, high performance tools. They can be used anywhere in the wide range of solder-free connection technology thanks to a comprehensive range of crimping dies.

Crimping stroke and pressure (to approx. 5.5 t) are created by several hand lever movements. The manual force required is low due to the high efficiency of the system. The press and the connecting parts can only be separated from one another when the crimp is complete. This drive system ensures that the required crimping depth is always achieved. The hinged cover guarantees comfortable handling of the press, even in awkward-to-reach positions such as in control cabinets.

By turning the fast forward feed lever to place the crimp inset on the cable lug, the number of manual lever movements is considerably reduced and rational work is guaranteed.

Only then does the actual crimping process begin with the hand lever. When the required crimping depth has been reached the press releases pressure spontaneously and the hinged cover can be opened to remove the connector. The crimping process can be interrupted if an error has been made in the choice of the inset, cable lug or cable. To do this swing the hand lever completely out, depress the ratchet and turn the forward feed lever backwards.

Crimping pliers

precise tool with ratchet and built-in-force-locking device, crimping pressure 50 kN, interchangeable dies, easy to remove from the crimped lug by opening the crimping head

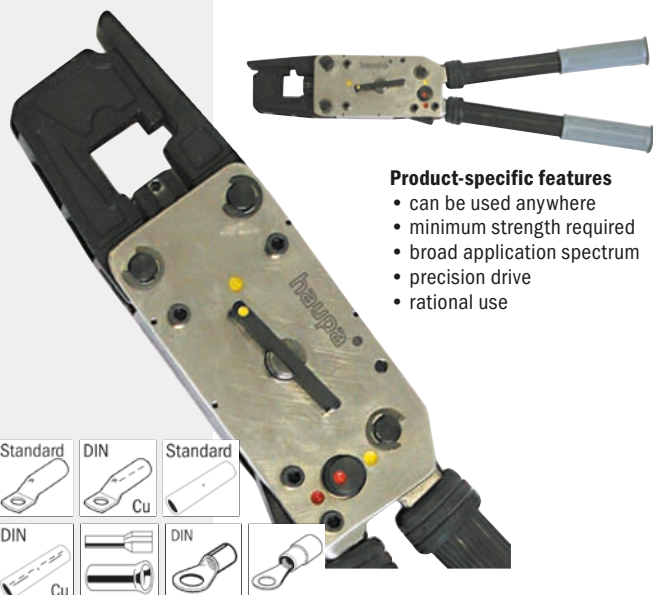

Product-specific features

- can be used anywhere
- minimum strength required
- broad application spectrum
- precision drive
- rational use

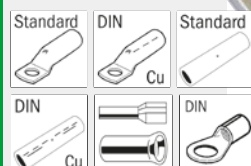

Art. no.	mm ²	kg	PU
215100	6 - 120	2,100	1

Metal box

for storing of crimping pliers and dies



Art. no.	kg	PU
215102	1,700	1

Crimping dies

for standard cable lugs and compacted cables, **WM pressing**

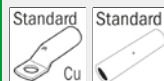

Art. no.	mm ²	kg	PU
215104	10 - 70	0,130	1
215106	16 - 35	0,132	1
215108	25 - 50	0,126	1
215110	95	0,138	1
215112	120	0,136	1

Crimping dies

for uninsulated crimping terminals, for up to four diameter, **mandrel shape pressing**, DIN 46234 + DIN 46341



Art. no.	mm ²	kg	PU
215114	6 - 70	0,080	1
215116	10 - 35	0,060	1
215118	16 - 50	0,055	1
215120	6 - 50	0,150	1
215122	70	0,150	1

Crimping dies

for insulated crimping terminals, **oval pressing**



Art. no.	mm ²	kg	PU
215124	10	0,147	1
215126	16	0,152	1
215128	25	0,153	1
215130	35	0,154	1

Crimping dies

for crimping terminals DIN, **hexagonal pressing**



Art. no.	Cu	Al	KZ	kg	PU
215142	-	10 - 50	6 - 16	0,128	1
215144	16 - 35	16 - 25	8 - 12	0,130	1
215146	25 - 50	25 - 35	10 - 14	0,130	1
215148	95	70	18	0,130	1
215150	120	-	20	0,130	1

Crimping dies

for rounding of square copper and aluminium



Art. no.	mm ²	kg	PU
215152	25 - 35	0,155	1
215154	35 - 70	0,150	1
215156	95	0,150	1

Crimping dies

for end sleeves, **trapezoid pressing**



Art. no.	mm ²	kg	PU
215164	25	0,059	1
215166	35	0,059	1
215168	50	0,059	1
215170	70	0,059	1
215172	95	0,059	1

haupa

... convincing solutions

INFO

Mechanical crimping pliers for tubular cable lugs

In this hand press the crimping stroke is produced by a number of hand lever movements. The transport ratchet starts the eccentric wheel moving and con-rods convert the eccentric turning motion into a straight-line stroke of the guide that runs in grooves.

The bottom crimping inset is placed in the guide. It sits on an adjustment plate that is screwed on to the guide. This plate compensates for all the tolerances resulting from the manufacturing process or wear and tear.

By turning the wheel on the handle in an anti-clockwise direction the crimping inset can be transported directly to the installation on the connecting part. Only then does the actual crimping process begin with the hand lever. When the required crimping depth has been reached the press releases the pressure spontaneously and the hinged cover can be opened to remove the connector.

The crimping process can be interrupted if an error has been made in the classification of the inset, cable lug or cable. To do this swing the hand lever completely out, depress the ratchet and turn the forward feed lever backwards. The quality of the crimped connection is dependent on the choice of cable lug, the crimp inset and the correct choice of cable cross section.

Crimping pliers

precise tool with ratchet and built-in-force-locking device, interchangeable dies, easy to remove from the crimped lug by opening the crimping head

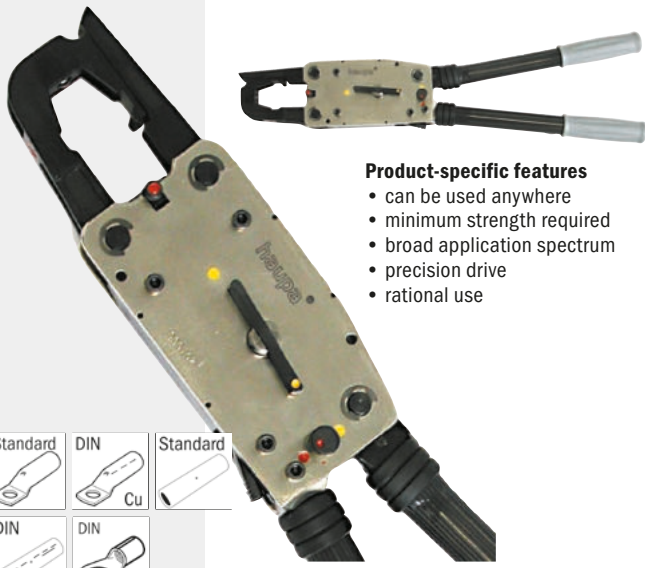

Product-specific features

- can be used anywhere
- minimum strength required
- broad application spectrum
- precision drive
- rational use

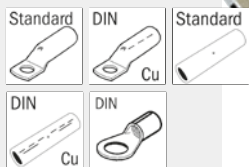

Art. no.	mm ²	kg	PU
215200	10 - 240	4,500	1

Metal box

for storing of crimping pliers and dies



Art. no.	kg	PU
215202	3,700	1

Crimping dies

for standard cable lugs and compacted cables, **WM pressing**

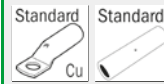

Art. no.	mm ²	kg	PU
215204	10 - 25	0,221	1
215206	16 - 35	0,320	1
215208	50	0,349	1
215210	70	0,331	1
215212	95	0,330	1
215201	120	2,486	1
215203	150	0,308	1
215205	185	0,317	1
215207	240	0,300	1

Crimping dies

for uninsulated crimping terminals, **mandrel shape pressing**,

DIN 46234 + DIN 46341



Art. no.	mm ²	kg	PU
215214	10 - 70	0,178	1
215216	95 - 150	0,169	1
215218	10 - 70	0,163	1
215220	16 - 35	0,170	1
215222	25 - 50	0,163	1
215224	95	0,161	1
215226	120	0,152	1
215228	150	0,144	1

Crimping dies

for crimping terminals DIN, **hexagon pressing**

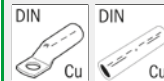

Art. no.	Cu	Al	KZ	kg	PU
215230	10	-	6	0,350	1
215232	16	-	8	0,330	1
215234	25	16	10	0,328	1
215236	35	25	12	0,330	1
215238	50	35	14	0,326	1
215240	70	50	16	0,326	1
215242	95	70	18	0,321	1
215244	120	-	20	0,300	1
215246	150	95 - 120	22	0,305	1
215248	185	150	25	0,305	1
215250	240	185	28	0,290	1



0,5

1,5

















0,25

















1,5

0,5

10

Pictogram cable connectors

	End sleeves
	TWIN end sleeves
	Insulated crimp-style cable lugs
	Insulated shrink connectors
	non-insulated cable lugs
	Socket sleeves (female)
	Socket sleeves (female) with cable stop
	Coaxial connectors
	for twisted contacts and connectors
	for rolled contacts and connectors
	for D-Sub connectors
	Multi-contact M3 for Photovoltaics
	Multi-contact M4 for Photovoltaics
	Amphenol for Photovoltaics
	Tyco-Solar for Photovoltaics
	Connectors for modular connectors

	Stewart connectors for modular connectors
	Hirose connectors for modular connectors
	non-insulated cable lugs DIN 46234
	non-insulated connectors DIN 46341
	Standard Cu standard tubular terminals
	DIN Cu DIN tubular terminals CU
	DIN Al DIN tubular terminals AL
	Light T standard tubular terminals, light
	Nylon-insulated tubular cable terminals
	Standard standard connectors CU
	DIN Cu DIN connectors CU
	DIN Al DIN connectors AL
	Ligth M standard connectors, light
	F-Type F-type
	Deep Indent Deep indent connectors
	Four thorn pressing without inserts

Pictogram press-profiles

Technical notes for the various pressing formats for the pressing of cables using HAUPA cable lugs and connectors.

The following pressing formats are available:



Hexagonal pressing
for pressing standard CU tubular terminals and connectors, tubular terminals for switching device connections, pressing cable lugs and connectors DIN 46235/DIN 46267, Al pressing cable lugs and connectors and end sleeves



Mandrel shape pressing
for pressing of standard CU tubular terminals and connectors, tubular terminals for switching device connections, crimp-style cable lugs DIN 46234 and pin cable lugs DIN 46230, insulated crimp-style cable lugs, conduit terminals for fine-wired conductors, nickel tubular terminals and connectors



Oval pressing
for pressing of dual pressing cable lugs, C clamps, insulated tubular terminals and connectors, insulated pin cable lugs, press connectors DIN 48217, insulated cable connections



Trapezoidal pressing
for pressing of end sleeves ends and twin end sleeves



Square pressing
for pressing of end sleeves ends and twin end sleeves



Hexagonal pressing
for pressing of end sleeves



Square pressing
Multi-contact
Application area:
Photovoltaics, twisted contacts



Roll pressing
for pressing of brass cable lugs, D-Sub, MC4



WM pressing
for standard cable lugs and compacted cables



Round pressing
of sector-shaped conductors 90° and 120°



Four thorn pressing
for pressing standard tubular terminals and connectors - also on sealed conductors - F-type tubular terminals and connectors Light cable lugs and connectors Tubular terminals = Switching device connections

Hydraulic crimping tools





Battery powered crimping tools with sensor technology

- Compression force in kN: 60 - 120
- Working pressure in bar: 700
- Pressing time, battery-operated in seconds: 4 - 10
- Battery type: Li-Ion, 18 V, 2 - 4 Ah

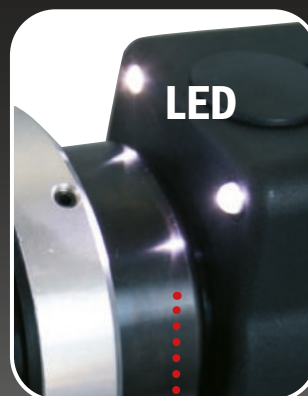
Working area illumination



-  Light is green: Pressing completed in accordance with standard, motor stopped
-  Light is orange: Battery voltage not sufficient
-  Light is red: Pressing interrupted before completed



Smart Battery powered crimping tool universal „US-6M“

Sensor

Hydraulics for interchangeable pressing tools, crimping head can be rotated by 180°, with fast opening, manual return flow after perfect pressure.

- for 4 different interchangeable heads (item no. 216761, item no. 216762, item no. 216763, item no. 216764)
- Heads can be changed easily
- Can be locked using 2 extractable pins
- Battery charging time in minutes: 30
- Battery type: Li-Ion, 18 V, 2 Ah
- With the new HAUPA battery item no. 215523 and charger item no. 215527
- Pressing load kN: 60
- Working pressure in bar: 700

With the different colours of the sensor LED, it shows whether the pressing has been completed successfully or which errors have occurred:

- Light is green: Pressing completed as standard, motor stopped.
- Light is orange: Battery voltage not sufficient
- Light is red: Pressing interrupted before completed

The device also has 1 white LED designed to illuminate the working area.

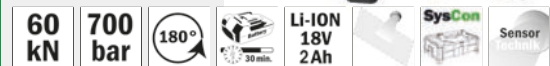

Art. no.	TL	kg	PU
216760-1	315	6,728	1
216760-1-NO	315	5,329	1
216760-1-N	315	2,413	1

Hydraulic hand pliers Universal „HUS-6“

Hand pliers for interchangeable pressing tools

- Pressing load kN: 60
- Working pressure in bar: 700



Art. no.	TL	kg	PU
216768	315	6,728	1



Scope of delivery for all battery-hydraulic cable cutters:
1 tool, 1 quick charger and 1 rechargeable battery in SysCon or system case incl. Insert.

For versions -NO:
no battery, no charger
For versions -N:
only machine in transport packaging

Crimping headstock „U-KO-6“

Pressing head for interchangeable pressing applications, with quick opening, without inserts.

- Head can be opened
- Opening / Hub: 17 mm
- Pressing width: slim
- Cable lugs: standard Cu 6-300 / DIN Cu 6-300 / DIN Al 16-300
- Connectors: standard Cu 6-300 / DIN Cu 6-300 / DIN Al 16-300

Corresponding inserts can be found on page 66.



Art. no.	mm ²	TL	kg	PU
216761	6 - 300	140	1,700	1

Crimping headstock „U-KDE240-6“

Pressing head with quick opening, indent v-shape pressing, no inserts required.

- Head can be opened
- Cable lugs / Connectors standard Cu: 10-240 mm²
- Cable lugs / Connectors DIN Al: 50-240 mm²
- DIN 46234 10-240 mm²

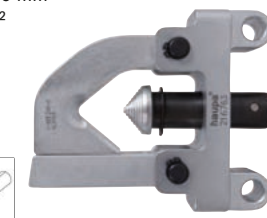

Art. no.	mm ²	TL	kg	PU
216763	16 - 240	130	1,200	1

Cutting headstock „U-KS6-S50“

for copper and aluminium cable



Art. no.	Ø	GL	kg	PU
216762	50	233	2,800	1

Punching headstock „U-S-6“

without inserts, including tension rods and adapter

Advantages:

- Head can be rotated by 360°
- Flexible aluminium head

Punching capacity:

Shaped holes 138 x 138 mm (ST37 2.5 mm)

Round holes 150 mm (ST37 3 mm) / 63 mm (VA 2 mm)

Corresponding punch inserts can be found on page 86.



Art. no.	TL	kg	PU
216764	180	2,700	1

haupa

... convincing solutions

Crimping headstock „U-D300-6“

Pressing head 4-mandrel „U-KD300-6“ for exchange head system US-6M (216760-1), insert does not need to be changed, **mandrel pressing**.

- Pressing force in kN: 60 kN
- Cable lugs: standard Cu 16 - 300
- Connectors: standard Cu 16 - 120

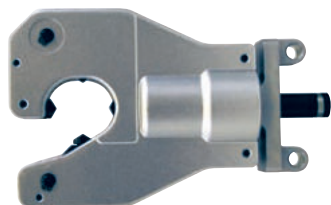

Art. no.	mm ²	TL	kg	PU
216665-U	16 - 300	180	2,700	1

Crimping headstock „U-D400-6“

Pressing head 4-mandrel „U-HKD400-6“ for exchange head system US-6M (216760-1), insert does not need to be changed, **mandrel pressing**.

- Pressing force in kN: 60 kN • Head can be opened
- Cable lugs: standard Cu 25 - 400
- Connectors: standard Cu 25 - 400



Art. no.	mm ²	TL	kg	PU
216666-U	25 - 400	180	2,700	1

Adapter for pumps

For hydraulic pump item 216357 so the interchangeable heads for the smart universal can be used (items 216761, 216762, 216763, 216764, 216665-U, 216666-U)

- with quick-lock hydraulic connection (Cejn Series 115)



700 bar

Art. no.	TL	kg	PU
216765	155	1,200	1

Scope of delivery for all battery-hydraulic cable cutters:
1 tool, 1 quick charger and 1 rechargeable battery in SysCon or system case incl. Insert.

For versions -NO: no battery, no charger
For versions -N: only machine in transport packaging

Universal set 1

Made up of item 216760-1, item 216763 and item 216762.

Technical data and scope of delivery see item 216760-1, item 216763 and item 216762.

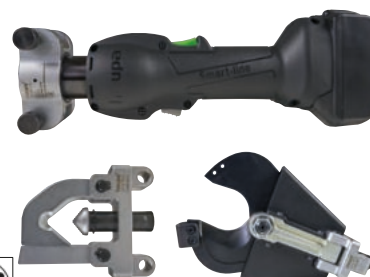

Art. no.	kg	PU
216766	Set 11,200	1

Universal set 2

Made up of item 216760-1, item 216761 and item 216762.

Technical data and scope of delivery see item 216760-1, item 216761 and item 216762.



Art. no.	kg	PU
216767	Set 11,700	1



Hydraulic crimping tools

Hydraulic hand pliers „HHs-6“

Crimping head can be rotated by 180°, manual return after completed pressing, light and compact construction in black plastic case, without dies.

- Pressing force in kN: 60
- Working pressure in bar: 700
- Head can be opened
- Pressing width: slim
- Cable lugs: standard Cu 10-240
- DIN Cu 10-185 • DIN Al 16-150
- Connectors: standard Cu 10-240
- DIN Cu 10-185 • DIN Al 16-150



185-H6

10-240 standard Cu	10-185 DIN Cu	16-150 DIN Al	10-240 standard Cu	10-185 DIN Cu	16-150 DIN Al	
60 kN	700 bar	180°				
Art. no.	mm ²	dimension		kg	PU	
215765	10 - 240	370 x 140 x 75 mm		4,600	1	

Battery powered crimping tool „SHs-6“

for interchangeable interchangeable dies, Crimping head can be rotated by 180°, manual return flow after perfect pressure.

- Pressing force in kN: 60 kN
- Working pressure in bar: 700
- Head can be opened
- Pressing width: slim
- Cable lugs: standard Cu 10-240 • DIN Cu 10-185 • DIN Al 16-150
- Connectors: standard Cu 10-240 • DIN Cu 10-185 • DIN Al 16-150
- Pressing time, battery-operated in seconds: 5
- Battery charging time in minutes: 30
- Battery type: Li-Ion 18 V, 2 Ah



185-H6

10-240 standard Cu	10-185 DIN Cu	16-150 DIN Al	10-240 standard Cu	10-185 DIN Cu	16-150 DIN Al	
60 kN	700 bar	180°		LI-ION 18V 2Ah		
Art. no.	mm ²	dimension		kg	PU	
215770-1	10 - 185	398 x 75 mm		6,540	1	
215770-1-NO	10 - 185	398 x 75 mm		5,370	1	
215770-1-N	10 - 185	398 x 75 mm		2,480	1	

Scope of delivery for all battery-hydraulic cable cutters:
1 tool, 1 quick charger and 1 rechargeable battery in SysCon or system case incl. Insert.

For versions -NO: no battery, no charger
For versions -N: only machine in transport packaging

Battery powered crimping tool „SHs-6M“



Technical data and scope of delivery, see 215770-1.

With the different colours of the sensor LED, it shows whether the pressing has been completed successfully or which errors have occurred:

- Light is green: Pressing completed as standard, motor stopped.
- Light is orange: Battery voltage not sufficient
- Light is red: Pressing interrupted before completed

The device also has 1 white LED designed to illuminate the working area.



185-H6

10-240 standard Cu	10-185 DIN Cu	16-150 DIN Al	10-240 standard Cu	10-185 DIN Cu	16-150 DIN Al	
60 kN	700 bar	180°		LI-ION 18V 2Ah		
Art. no.	mm ²	dimension		kg	PU	
215770/M-1	10 - 185	398 x 75 mm		6,570	1	
215770/M-1-NO	10 - 185	398 x 75 mm		5,400	1	
215770/M-1-N	10 - 185	398 x 75 mm		2,480	1	

Crimping dies standard

standard copper tube terminals and connectors, **hexagonal pressing**

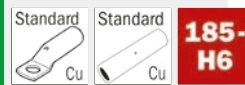

Art. no.	mm ²	PB	kg	PU
215641	10/16	5	0,157	1
215642	25/35	5	0,155	1
215643	50/70	5	0,150	1
215644	95/120	5	0,145	1
215645	150	5	0,159	1
215646	185	5	0,156	1
215648	240	5	0,156	1

Crimping dies DIN

DIN Cu/Al tube terminals and connectors, **hexagonal pressing**

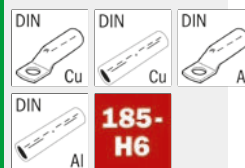

Art. no.	mm ²	PB	KZ	kg	PU
215650	10/16	5	6/8	0,155	1
215651	25/35	5	10/12	0,151	1
215652	50/70	5	14/16	0,149	1
215653	95/120	5	18/20	0,129	1
215654	150	5	22	0,145	1
215655	185	5	25	0,147	1

Hydraulic crimping tools

Battery powered crimping tool „SH-6“

Hydraulic for interchangeable dies, crimping head can be rotated by 180°, with fast opening, manual return flow after perfect pressure.

- Pressing force in kN: 60 kN
- Working pressure in bar: 700
- Head can be opened yes
- Opening/ Hub: 17 mm
- Pressing width: slim
- Cable lugs: standard Cu 10-240 • DIN Cu 10-240 • DIN Al 16-185
- Connectors: Cu 10-240 • DIN Cu 10-240 • DIN Al 16-185
- Pressing time, battery-operated in seconds: ca. 5
- Battery charging time in minutes: 30
- Battery type: Li-Ion, 18 V, 2 Ah



Art. no.	mm ²	dimension	kg	PU
215881-1	10 - 240	415 x 75 mm	6,650	1
215881-1-NO	10 - 240	415 x 75 mm	5,480	1
215881-1-N	10 - 240	415 x 75 mm	2,560	1

Battery powered crimping tool „SH-6M“

Sensor

Technical data and scope of delivery, see 215881-1.

With the different colours of the sensor LED, it shows whether the pressing has been completed successfully or which errors have occurred:

- Light is green: Pressing completed as standard, motor stopped.
- Light is orange: Battery voltage not sufficient
- Light is red: Pressing interrupted before completed

The device also has 1 white LED designed to illuminate the working area.



Art. no.	mm ²	Größe	kg	PU
215881/M-1	10 - 240	415 x 75 mm	6,670	1
215881/M-1-NO	10 - 240	415 x 75 mm	5,500	1
215881/M-1-N	10 - 240	415 x 75 mm	2,590	1

Hydraulic hand pliers „HH-6“

Crimping head can be rotated by 180°, manual return after completed pressing, light and compact construction, in SysCon stacking box, without dies.

- Pressing force in kN: 60
- Working pressure in bar: 700
- Opening / Hub: 17 mm
- Head can be opened
- Pressing width: slim
- Cable lugs: standard Cu 10-240 • DIN Cu 10-240 • DIN Al 16-185
- Connectors: standard Cu 10-240 • DIN Cu 10-240 • DIN Al 16-185
- Dual-piston pump
- Weight in kg: 3,0
- Weight of set in kg: 4,5



Art. no.	mm ²	dimension	kg	PU
215800	10 - 240	400 x 150 x 65 mm	4,500	1

Crimping dies

standard copper tube terminals and connectors, **hexagonal pressing**



Art. no.	mm ²	kg	PU
215852	10 - 16	0,157	1
215854	25 - 35	0,155	1
215856	50 - 70	0,150	1
215858	95 - 120	0,145	1
215859	150	0,159	1
215860	185	0,156	1
215861	240	0,156	1

Crimping dies DIN Cu + Al

DIN Cu/Al tube terminals and connectors, **hexagonal pressing**



Art. no.	mm ²	Al	Id.	kg	PU
215862	10 - 16	-	6 - 8	0,155	1
215864	25 - 35	16 - 25	10 - 12	0,151	1
215866	50 - 70	35 - 50	14 - 16	0,149	1
215868	95 - 120	70	18 - 20	0,129	1
215869	150	95 - 120	22	0,145	1
215870	185	150	25	0,147	1
215872	240	185	28	0,114	1

Scope of delivery for all battery-hydraulic cable cutters:
1 tool, 1 quick charger and 1 rechargeable battery in SysCon or system case incl. Insert.

For versions -NO: no battery, no charger
For versions -N: only machine in transport packaging

Hydraulic crimping tools

Battery powered crimping tool „S0-6“

Hydraulic for interchangeable dies, crimping head can be rotated by 180°, Head can be opened, manual return flow after perfect pressure.

- Pressing force in kN: 60 kN
- Working pressure in bar: 700
- Head can be opened
- Opening/ Hub: 17 mm
- Pressing width: slim
- Pressing time, battery-operated in seconds: ca. 5
- Battery charging time in minutes: 30
- Battery type: Li-Ion, 18 V, 2 Ah
- With the new HAUPA battery item no. 215523 and charger item no. 215527
- Cable lugs: standard Cu 6-300 • DIN Cu 6-300 • DIN Al 16-300
- Connectors: Cu 6-300 • DIN Cu 6-300 • DIN Al 16-300

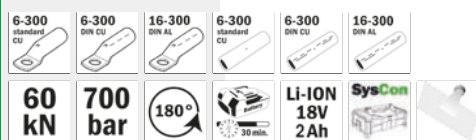

Art. no.	mm ²	dimension	kg	PU
216801-1	6 - 300	383 x 75 mm	7,070	1
216801-1-NO	6 - 300	383 x 75 mm	5,910	1
216801-1-N	6 - 300	383 x 75 mm	2,990	1

Battery powered crimping tool „S0-6M“

Sensor

Technical data and scope of delivery, see 216801.

With the different colours of the sensor LED, it shows whether the pressing has been completed successfully or which errors have occurred:

- Light is green: Pressing completed as standard, motor stopped.
- Light is orange: Battery voltage not sufficient
- Light is red: Pressing interrupted before completed

The device also has 1 white LED designed to illuminate the working area.



Art. no.	mm ²	dimension	kg	PU
216801/M-1	6 - 300	383 x 75 mm	6,670	1
216801/M-1-NO	6 - 300	383 x 75 mm	5,920	1
216801/M-1-N	6 - 300	383 x 75 mm	3,000	1

Battery powered crimping tool „A0-6“

Sensor

2 step hydraulic for replaceable pressing dies, crimping head can be rotated by 180°, can be opened, with quick opening, manual return after completed pressing, LED to check battery status.

- Pressing force in kN: 60
- Working pressure in bar: 700
- Opening/ Hub: 17 mm
- Head can be opened
- Pressing width: slim
- Cable lugs: standard Cu 6-300 • DIN Cu 6-300 • DIN Al 16-300
- Connectors: standard Cu 6-300 • DIN Cu 6-300 • DIN Al 16-300
- Pressing time, battery-operated in seconds: 4
- Battery charging time in minutes: 120
- Battery type: Li-Ion 18 V, 4 Ah
- Dual-piston pump

With the different colours of the sensor LED, it shows whether the pressing has been completed successfully or which errors have occurred:

- Light is green: Pressing completed as standard, motor stopped.
- Light is orange: Battery voltage not sufficient
- Light is red: Pressing interrupted before completed

The device also has 2 white LED designed to illuminate the working area.

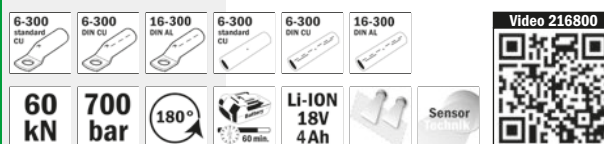

Art. no.	mm ²	dimension	kg	PU
216800-1	6 - 300	375 x 343 x 75 mm	9,400	1
216800-1-NO	6 - 300	375 x 343 x 75 mm	8,000	1
216800-1-N	6 - 300	375 x 343 x 75 mm	4,750	1

Scope of delivery for all battery-hydraulic cable cutters:
 1 tool, 1 quick charger and 1 rechargeable battery in SysCon or system case incl. Insert.
 For versions -NO: no battery, no charger
 For versions -N: only machine in transport packaging

haupa®

... convincing solutions

Hydraulic crimping tools

Hydraulic hand pliers „HO-6“

Crimping head can be rotated by 180°, manual return after completed pressing, light and compact construction in black plastic case, without dies.

- Pressing force in kN: 60
- Working pressure in bar: 700
- Head can be opened
- Opening / Hub: 17 mm
- Pressing width: slim
- Cable lugs: standard Cu 6-300 • DIN Cu 6-300 • DIN Al 16-300
- Connectors: standard Cu 6-300 • DIN Cu 6-300 • DIN Al 16-300
- Dual-piston pump
- Weight in kg: 3,5
- Weight of set in kg: 5,0



Art. no.	mm ²	dimension	kg	PU
216802	6 - 300	500 x 170 x 80 mm	5,000	1

Hand pliers „MO-6“ for exchangeable dies

Extent of supply: 1 crimping tool, in metal suitcase.

- Crimping range cable lugs: Cu 6-300 • DIN Cu 6-300 / DIN Al 16-300
- Crimping range connectors: Cu 6-300 • DIN Cu 6-300 / DIN Al 16-300



Art. no.	mm ²	dimension	kg	PU
216804	10 - 300	765 x 175 mm	11,800	1

Crimping headstock „KO-6“

in plastic case, without dies.

- Pressing force in kN: 60
- Working pressure in bar: 700
- Head can be opened
- Opening / Hub: 17 mm
- Pressing width: slim
- Cable lugs: standard Cu 6-300 • DIN Cu 6-300 • DIN Al 16-300
- Connectors: standard Cu 6-300 • DIN Cu 6-300 • DIN Al 16-300
- Quick coupling
- Weight in kg: 3,2
- Weight of set in kg: 4,2



Art. no.	mm ²	dimension	kg	PU
216807	6 - 300	235 x 91,5 x 57 mm	4,200	1

Crimping Dies

Crimping dies set Standard Cu

13 standard crimping dies in practical transport case
Set contains:

216806 CU 6, 216808 CU 10, 216810 CU 16, 216812 CU 25,
216814 CU 35, 216816 CU 50, 216818 CU 70, 216820 CU 95,
216822 CU 120, 216824 CU 150, 216826 CU 185,
216828 CU 240, 216830 CU 300

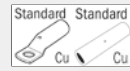

Art. no.	TL	mm ²	kg	PU
216805-SET	235	6 - 300	4,200	1

Crimping dies set DIN Cu

12 DIN-Crimping dies in practical transport case

Set contains:

216834 DIN 10, 216836 DIN 16, 216838 DIN 25, 216840 DIN 35,
216842 DIN 50, 216844 DIN 70, 216846 DIN 95, 216848 DIN 120,
216850 DIN 150, 216852 DIN 185, 216854 DIN 240, 216856 DIN 300

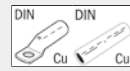

Art. no.	TL	mm ²	kg	PU
216831-SET	235	10 - 300	4,200	1

Crimping dies set DIN Aluminium

9 DIN-Crimping dies in practical transport case

Set contains:

216840/AL DIN 16-25, 216842/AL DIN 35, 216844/AL DIN 50,
216846/AL DIN 70, 216850/AL DIN 95-120, 216852/AL DIN 150,
216854/AL DIN 185, 216856/AL DIN 240,
216858/AL DIN 300



Art. no.	TL	mm ²	kg	PU
216840/AL-SET	235	16 - 300	4,200	1

Crimping dies set Standard Aluminium

9 standard crimping dies in practical transport case

Set contains:

216812/Al AL 25, 216814/Al AL 35, 216816/Al AL 50,
216818/Al AL 70, 216820/Al AL 95, 216822/Al AL 120,
216824/Al AL 150, 216826/Al AL 185, 216828/Al AL 240



Art. no.	TL	mm ²	kg	PU
216812/AL-SET	235	25 - 240	4,200	1

Dies

Dies for terminals and connectors DIN

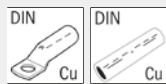

Cu



300-06

Art. no.	Cu	ld.	PW	kg	PU
216832	6	5	5	0,123	1
216834	10	6	5	0,122	1
216836	16	8	5	0,125	1
216838	25	10	5	0,120	1
216840	35	12	5	0,120	1
216842	50	14	5	0,119	1
216844	70	16	5	0,120	1
216846	95	18	5	0,120	1
216848	120	20	5	0,120	1
216850	150	22	5	0,120	1
216852	185	25	5	0,120	1
216854	240	28	5	0,115	1
216856	300	32	5	0,120	1

Dies for terminals and connectors standard

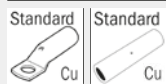

Cu



300-06

Art. no.	mm ²	PW	kg	PU
216806	6	5	0,136	1
216808	10	5	0,136	1
216810	16	5	0,136	1
216812	25	5	0,135	1
216814	35	5	0,135	1
216816	50	5	0,134	1
216818	70	5	0,132	1
216820	95	5	0,132	1
216822	120	5	0,130	1
216824	150	5	0,128	1
216826	185	5	0,125	1
216828	240	5	0,121	1
216830	300	5	0,118	1

Dies for terminals and compacted connectors

for standard tube terminals and compacted connectors, also on compacted thinned connectors

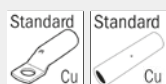

Cu



300-06

Art. no.	mm ²	PW	kg	PU
216806/V	6	5	0,136	1
216808/V	10	5	0,136	1
216810/V	16	5	0,136	1
216812/V	25	5	0,135	1
216814/V	35	5	0,135	1
216816/V	50	5	0,134	1
216818/V	70	5	0,132	1
216820/V	95	5	0,132	1
216822/V	120	5	0,130	1
216824/V	150	5	0,128	1
216826/V	185	5	0,125	1
216828/V	240	5	0,121	1
216830/V	300	5	0,118	1



Dies for tubular terminals „F-Type“



300-06

Cu



Art. no.	mm ²	PW	kg	PU
216878	10	8	0,146	1
216880	16	9	0,153	1
216882	25	11	0,162	1
216884	35	13	0,171	1
216886	50	13	0,167	1
216888	70	13	0,160	1
216890	95	13	0,164	1
216892	120	20	0,174	1
216894	150	20	0,162	1
216896	185	8	0,124	1
216898	240	8	0,119	1
216899	300	8	0,089	1

Dies for end sleeves

for end sleeves on compacted thinned connectors (wave form)



300-06

Cu



Art. no.	mm ²	kg	PU
216952	10	0,120	1
216954	16	0,120	1
216956	25	0,120	1
216958	35	0,120	1
216960	50	0,120	1
216962	70	0,120	1
216964	95	0,120	1
216966	120	0,120	1
216968	150	0,120	1
216970	185	0,120	1
216972	240	0,120	1

Dies for rounding of round conductors

300-06

Cu
Al



Art. no.	mm ²	sm	se	kg	PU
216926	10	10	-	0,120	1
216928	16	16	-	0,120	1
216930	25 - 35	25	35	0,120	1
216932	35 - 50	35	50	0,120	1
216934	50 - 70	50	70	0,120	1
216936	70 - 95	70	95	0,120	1
216938	95 - 120	95	120	0,120	1
216940	120 - 150	120	150	0,240	1
216942	150 - 185	150	185	0,197	1
216944	185 - 240	185	240	0,120	1
216946	240 - 300	240	300	0,120	1

haupa

... convincing solutions

Oval crimp for stripped pipe cable lugs

300-06

Cu



Art. no.	mm ²	PW	kg	PU
216670	10	5	0,136	1
216672	16	5	0,136	1
216674	25	5	0,136	1
216676	35	5	0,135	1
216678	50	5	0,135	1
216680	70	5	0,134	1
216682	95	5	0,134	1
216684	120	5	0,134	1
216686	150	5	0,134	1

Dies for indent crimping for compacted cables

300-06

Cu



Art. no.	mm ²	kg	PU
216863	16	0,136	1
216865	25	0,136	1
216867	35	0,136	1
216869	50	0,135	1
216871	70	0,135	1
216873	95	0,134	1
216875	120	0,134	1
216877	150	0,134	1

Dies for standard aluminium pipe cable lugs



300-06

Al



Art. no.	mm ²	PW	kg	PU
216812/AL	16-25	7	0,135	1
216814/AL	35	7	0,135	1
216816/AL	50	7	0,134	1
216818/AL	70	7	0,132	1
216820/AL	95	7	0,132	1
216822/AL	120	7	0,13	1
216824/AL	150	7	0,128	1
216826/AL	185	7	0,125	1
216828/AL	240	7	0,121	1

Dies for C-connectors

300-06

Cu



Art. no.	mm ²	PW	kg	PU
216984	16	5	0,135	1
216984/25	25	5	0,135	1
216985	35	5	0,135	1
216986	50	5	0,134	1
216986/70	70	5	0,132	1
216987	4-4	5	0,132	1
216988	10-10	5	0,132	1
216989	10-1	5	0,132	1

Dies for connectors with notch



300-06

Al



Art. no.	mm ²	kg	PU
216813	25	0,143	1
216815	35	0,143	1
216817	50	0,143	1
216819	70	0,143	1
216821	95	0,143	1
216823	120	0,143	1

Dies for DIN aluminium pipe cable lugs



300-06

Al



Art. no.	mm/sm	re/se	mm ²	PW	ld	kg	PU
216840/AL	16-25	25-35	7	12	0,120	1	
216842/AL	35	50	7	14	0,119	1	
216844/AL	50	70	7	16	0,120	1	
216846/AL	70	95	7	18	0,120	1	
216850/AL	95-120	120-150	7	22	0,120	1	
216852/AL	150	185	7	25	0,120	1	
216854/AL	185	240	7	28	0,120	1	
216856/AL	240	300	5	32	0,115	1	
216858/AL	300	400	5	34	0,120	1	

Hydraulic crimping tools

Battery powered crimping tool „AC25-12“

Sensor

2 step hydraulic for replaceable pressing dies, crimping head can be rotated by 180°, can be opened, with quick opening, manual return after completed pressing, LED to check battery status.

- Pressing force in kN: 120
- Working pressure in bar: 700
- Opening/ Hub: 25 mm
- Pressing width: wide
- Cable lugs: standard Cu 10-400 • DIN Cu 10-300 • DIN Al 16-300
- Connectors: standard Cu 10-185 • DIN Cu 10-150 • DIN Al 16-120
- Pressing time, battery-operated in sec.: 6 - 12
- Battery charging time in min.: 120
- Battery type: Li-Ion, 18 V, 4 Ah
- Dual-piston pump

With the different colours of the sensor LED, it shows whether the pressing has been completed successfully or which errors have occurred:

- Light is green: Pressing completed as standard, motor stopped.
- Light is orange: Battery voltage not sufficient
- Light is red: Pressing interrupted before completed

The device also has 2 white LED designed to illuminate the working area.



400-C12

10-400 Standard CU	10-300 DIN CU	16-300 DIN AL	10-185 Standard CU	10-150 DIN CU	16-120 DIN AL
120 kN	700 bar	180°	60 min.	LI-ION 18V 4Ah	Sensor Technik

Video 216601

Art. no.	mm ²	dimension	kg	PU
216601-1	10 - 400	375 x 375 x 75 mm	11,830	1
216601-1-NO	10 - 400	375 x 375 x 75 mm	9,150	1
216601-1-N	10 - 400	375 x 375 x 75 mm	5,900	1

Scope of delivery for all battery-hydraulic cable cutters:
1 tool, 1 quick charger and 1 rechargeable battery in SysCon or system case incl. Insert.

For versions -NO: no battery, no charger
For versions -N: only machine in transport packaging

Hydraulic hand pliers „HC25-12“

Crimping head can be rotated by 180°, manual return after completed pressing, light and compact construction in black plastic case, without dies.

- Pressing force in kN: 120
- Working pressure in bar: 700
- Opening/ Hub: 25 mm
- Pressing width: wide
- Cable lugs: standard Cu 10-400 • DIN Cu 10-300 • DIN Al 16-300
- Connectors: standard Cu 10-185 • DIN Cu 10-150 • DIN Al 16-120
- Dual-piston pump
- Weight in kg: 6,2
- Weight of set in kg: 7,7



400-C12

10-400 Standard CU	10-300 DIN CU	16-300 DIN AL	10-185 Standard CU	10-150 DIN CU	16-120 DIN AL
120 kN	700 bar	180°			

Art. no.	mm ²	dimension	kg	PU
216124	10 - 400	585 x 180 x 72 mm	7,700	1

Hydraulic crimping headstock „KC25-12“

in plastic case, without dies.

- Pressing force in kN: 120
- Working pressure in bar: 700
- Cable lugs: standard Cu 10-400 • DIN Cu 10-300 • DIN Al 16-300
- Connectors: standard Cu 10-185 • DIN Cu 10-150 • DIN Al 16-120
- Opening/ Hub: 25 mm
- Pressing width: wide
- Quick coupling
- Weight in kg: 3,6
- Weight of set in kg: 4,6



400-C12

10-400 Standard CU	10-300 DIN CU	16-300 DIN AL	10-185 Standard CU	10-150 DIN CU	16-120 DIN AL
120 kN	700 bar				

Art. no.	mm ²	dimension	kg	PU
216004	10 - 400	245 x 130 x 72 mm	4,600	1

haupa®

... convincing solutions

Hydraulic crimping tools

Battery powered crimping tool „AC42-12“

Sensor

2 step hydraulic for replaceable pressing dies, crimping head can be rotated by 180°, can be opened, with quick opening, manual return after completed pressing, LED to check battery status.

- Pressing force in kN: 120
- Working pressure in bar: 700
- Opening/ Hub: 42 mm
- Pressing width: wide
- Cable lugs: standard Cu 10-400 • DIN Cu 10-300 • DIN Al 16-300
- Connectors: standard Cu 10-400 • DIN Cu 10-300 • DIN Al 16-300
- Pressing time, battery-operated in sec.: 7 - 13
- Battery charging time in min.: 120
- Battery type: Li-Ion, 18 V, 4 Ah
- Dual-piston pump

With the different colours of the sensor LED, it shows whether the pressing has been completed successfully or which errors have occurred:

- Light is green: Pressing completed as standard, motor stopped.
- Light is orange: Battery voltage not sufficient
- Light is red: Pressing interrupted before completed

The device also has 2 white LED designed to illuminate the working area.



400-C12

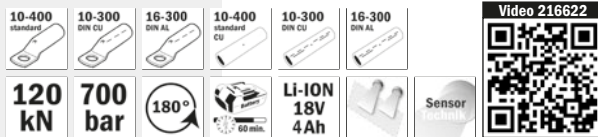

Art. no.	mm ²	dimension	kg	PU
216622-1	10 - 400	430 x 340 x 75 mm	11,830	1
216622-1-NO	10 - 400	430 x 340 x 75 mm	10,430	1
216622-1-N	10 - 400	430 x 340 x 75 mm	7,180	1

Scope of delivery for all battery-hydraulic cable cutters:
1 tool, 1 quick charger and 1 rechargeable battery in SysCon or system case incl. Insert.

For versions -NO: no battery, no charger
For versions -N: only machine in transport packaging

Hydraulic hand pliers „HC42-12“

Crimping head can be rotated by 180°, manual return after completed pressing, light and compact construction in black plastic case, without dies.

- Pressing force in kN: 120
- Working pressure in bar: 700
- Opening/ Hub: 42 mm
- Pressing width: wide
- Cable lugs: standard Cu 10-400 • DIN Cu 10-300 • DIN Al 16-300
- Connectors: standard Cu 10-400 • DIN Cu 10-300 • DIN Al 16-300
- Dual-piston pump
- Weight in kg: 8,2
- Weight of set in kg: 9,7



400-C12

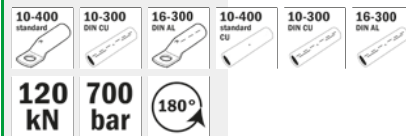

Art. no.	mm ²	dimension	kg	PU
216125	10 - 400	640 x 170 x 77 mm	9,700	1

Hydraulic crimping headstock „KC42-12“

in plastic case, without dies.

Pressing force in kN: 120

- Working pressure in bar: 700
- Opening/ Hub: 42 mm
- Pressing width: wide
- Cable lugs: standard Cu 10-400 • DIN Cu 10-300 • DIN Al 16-300
- Connectors: standard Cu 10-400 • DIN Cu 10-300 • DIN Al 16-300
- Quick coupling
- Weight in kg: 5,3
- Weight of set in kg: 6,3



400-C12

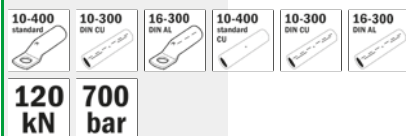

Art. no.	mm ²	dimension	kg	PU
216005	10 - 400	320 x 130 x 76 mm	6,300	1

Hydraulic crimping tools

Battery powered crimping tool „AH-12“

Sensor

2 step hydraulic for replaceable pressing dies, crimping head can be rotated by 180°, can be opened, with quick opening, manual return after completed pressing, LED to check battery status.

Pressing tool for deep indent pressing.

- Pressing force in kN: 120
- Working pressure in bar: 700
- Head can be opened
- Opening/ Hub: 20 mm
- Pressing width: wide
- Cable lugs: standard Cu 10-400 • DIN Cu 10-300 • DIN Al 16-300
- Connectors: standard Cu 10-400 • DIN Cu 10-300 • DIN Al 16-300
- Pressing time, battery-operated in sec.: 6 - 13
- Battery charging time in minutes: 120
- Battery type: Li-Ion, 18 V, 4 Ah
- Dual-piston pump

With the different colours of the sensor LED, it shows whether the pressing has been completed successfully or which errors have occurred:

- Light is green: Pressing completed as standard, motor stopped.
- Light is orange: Battery voltage not sufficient
- Light is red: Pressing interrupted before completed

The device also has 2 white LED designed to illuminate the working area.



400-C12

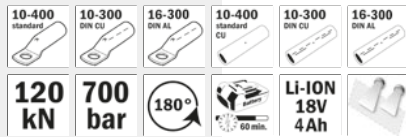

Art. no.	mm ²	dimension	kg	PU
216503-1	10 - 400	405 x 353 x 75 mm	10,970	1
216503-1-NO	10 - 400	405 x 353 x 75 mm	9,570	1
216503-1-N	10 - 400	405 x 353 x 75 mm	5,320	1

Scope of delivery for all battery-hydraulic cable cutters:
1 tool, 1 quick charger and 1 rechargeable battery in SysCon or system case incl. Insert.

For versions -NO: no battery, no charger
For versions -N: only machine in transport packaging

Hydraulic hand pliers „HH-12“

Crimping head can be rotated by 180°, manual return flow after perfect pressure, in black metal suitcase, without dies.

- Pressing force in kN: 120
- Working pressure in bar: 700
- Head can be opened
- Opening/ Hub: 20 mm
- Pressing width: wide
- Cable lugs: standard Cu 10-400 • DIN Cu 10-300 • DIN Al 16-300
- Connectors: standard Cu 10-400 • DIN Cu 10-300 • DIN Al 16-300
- Dual-piston pump
- Weight in kg: 4,0
- Weight set in kg: 5,0



400-C12

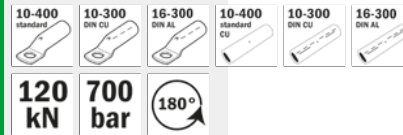

Art. no.	mm ²	dimension	kg	PU
215946	10 - 400	615 x 180 x 76 mm	7,500	1

Crimping headstock „KH-12“

in plastic case, without dies.

- Pressing force in kN: 120
- Working pressure in bar: 700
- Head can be opened
- Opening/ Hub: 20 mm
- Pressing width: wide
- Cable lugs: standard Cu 10-400 • DIN Cu 10-300 • DIN Al 16-300
- Connectors: standard Cu 10-400 • DIN Cu 10-300 • DIN Al 16-300
- Quick coupling
- Weight in kg: 4
- Weight of set in kg: 5



400-C12

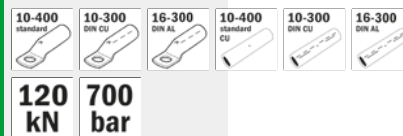

Art. no.	mm ²	dimension	kg	PU
215980	10 - 400	275 x 90 x 76 mm	5,000	1

haupa®

... convincing solutions

Crimping dies DIN

for Copper and Aluminium, **hexagonal pressing**



400-C12

Cu



Art. no.	mm ²	PW	ld.	kg	PU
216036	10	10	6	0,248	1
216038	16	10	8	0,248	1
216040	25	13	10	0,244	1
216042	35	13	12	0,235	1
216044	50	13	14	0,231	1
216046	70	13	16	0,226	1
216048	95	14	18	0,229	1
216050	120	14	20	0,225	1
216052	150	10	22	0,197	1
216054	185	10	25	0,193	1
216056	240	10	28	0,185	1
216060	300	10	32	0,142	1

Crimping dies

Standard copper tube terminals and connectors, **hexagonal pressing**

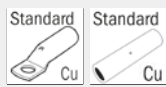

400-C12

Cu



Art. no.	mm ²	PW	kg	PU
216008	10	10	0,211	1
216010	16	10	0,212	1
216012	25	10	0,210	1
216014	35	13	0,207	1
216016	50	13	0,224	1
216018	70	14	0,221	1
216020	95	14	0,226	1
216022	120	14	0,200	1
216024	150	11	0,200	1
216026	185	11	0,191	1
216028	240	11	0,186	1
216030	300	11	0,200	1
216032	400	11	0,200	1

Dies for compacted connectors

for standard cable lugs and compacted connectors, also on compacted thinned connectors

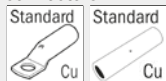

400-C12

Cu



Art. no.	mm ²	PW	kg	PU
216008/V	10	10	0,211	1
216010/V	16	10	0,212	1
216012/V	25	10	0,210	1
216014/V	35	13	0,207	1
216016/V	50	13	0,224	1
216018/V	70	14	0,221	1
216020/V	95	14	0,226	1
216022/V	120	14	0,200	1
216024/V	150	11	0,200	1
216026/V	185	11	0,191	1
216028/V	240	11	0,186	1
216030/V	300	11	0,200	1
216032/V	400	11	0,200	1

Crimping dies DIN

for DIN Aluminium terminals and connectors, **hexagonal pressing**



400-C12

Al



Art. no.	rm/sm	re/se	PW	ld.	kg	PU
216042/AL	16-25	25-35	12	12	0,235	1
216044/AL	35	50	12	14	0,231	1
216046/AL	50	70	12	16	0,226	1
216048/AL	70	95	12	18	0,229	1
216052/AL	95-120	120-150	14	22	0,197	1
216054/AL	150	185	14	25	0,193	1
216056/AL	185	240	14	28	0,185	1
216060/AL	240	300	17	32	0,142	1
216062/AL	300	-	17	34	0,142	1

Crimping dies

for standard Aluminium terminals and connectors, **hexagonal pressing**

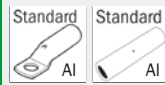

400-C12

Al



Art. no.	mm ²	PW	kg	PU
216012/AL	16-25	10	0,210	1
216014/AL	35	10	0,207	1
216016/AL	50	13	0,224	1
216018/AL	70	13	0,221	1
216020/AL	95	13	0,226	1
216022/AL	120	13	0,200	1
216024/AL	150	14	0,200	1
216026/AL	185	14	0,191	1
216028/AL	240	10	0,186	1

Crimping dies

Standard copper tube terminals and connectors, **mandrel shape crimping**

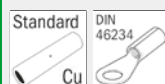

400-C12

Cu



Art. no.	mm ²	kg	PU
216064	10	0,200	1
216066	16	0,120	1
216068	25	0,118	1
216070	35	0,116	1
216072	50	0,118	1
216074	70	0,131	1
216076	95	0,119	1
216078	120	0,111	1
216080	150	0,107	1
216082	185	0,095	1
216084	240	0,085	1
216086	300	0,060	1
216065	10 - 25	0,112	1
216067	35 - 50	0,121	1
216069	70 - 120	0,136	1
216071	150 - 300	0,125	1

Crimping dies for cable class 5+6, F-Type



tubular terminals and connectors, F-Type



400-C12

Cu



Art. no.	mm ²	PW	kg	PU
216160	10	8	0,211	1
216162	16	8	0,216	1
216164	25	11	0,227	1
216168	50	13	0,232	1
216166	35	13	0,234	1
216170	70	13	0,111	1
216172	95	13	0,230	1
216174	120	20	0,247	1
216176	150	20	0,235	1
216178	185	8	0,190	1
216180	240	8	0,179	1
216182	300	8	0,126	1

Crimping dies



for prerounding of square connectors

400-C12

Cu
Al



Art. no.	mm ²	sm	se	kg	PU
216088	50	50	70	0,518	1
216090	70	70	95	0,505	1
216092	95	95	120	0,489	1
216094	120	120	150	0,474	1
216096	150	150	185	0,463	1
216098	185	185	240	0,441	1
216100	240	240	300	0,406	1

Crimping dies



for end sleeves and compacted thinned conductors, wave form



400-C12

Cu



Art. no.	mm ²	PW	kg	PU
216112	50	26	0,194	1
216114	70	26	0,200	1
216116	95	26	0,188	1
216118	120	26	0,200	1
216120	150	26	0,200	1
216122	185	26	0,200	1
216123	240	26	0,200	1

Crimping dies



for insulated tube terminals, oval pressing



400-C12

Cu



Art. no.	mm ²	PW	kg	PU
216126	10	5	0,200	1
216128	16	5	0,200	1
216130	25	5	0,220	1
216132	35	5	0,218	1
216134	50	5	0,200	1
216136	70	5	0,200	1
216138	95	5	0,200	1
216140	120	5	0,200	1
216142	150	5	0,200	1

Crimping dies



C-connectors, oval pressing

400-C12

Cu



Art. no.	mm ²	PW	kg	PU
216148	16	16	0,135	1
216149	25	17	0,135	1
216150	35	20	0,135	1
216152	50	20	0,134	1
216153	70	20	0,132	1
216154	70	30	0,132	1
216156	95	30	0,132	1
216157	120	20	0,132	1

Deep indent crimping accessories

Cu

Pressing inserts „Deep Indent“ (AH-12/KH-12/HH-12)



for conduit terminals and connectors, thorn pressing



Art. no.	mm ²	kg	PU
216552	50 - 70	Cable Lugs	0,211 1
216554	95 - 185	Cable Lugs	0,211 1
216556	240	Cable Lugs	0,211 1
216562	50 - 70	Connectors	0,211 1
216564	95 - 185	Connectors	0,211 1
216566	240	Connectors	0,211 1

Adapter pressing thorn



Art. no.	dimension	kg	PU
216570	1 - 4	0,211	1

Pressing thorn



Art. no.	mm ²	dimension	kg	PU
216574	50 - 70	1	0,211	1
216576	95 - 185	2	0,211	1
216578	240	4	0,211	1

Holder for „Deep Indent“ pressing inserts



Art. no.	mm ²	kg	PU
216580	50 - 185	0,211	1
216582	240	0,211	1

Battery powered crimping tool „SDE240-6“

Crimping head can be rotated by 180°, with fast opening, return manually once compressing is complete, no inserts required, **mandrel shape pressing**.

- Pressing force in kN: 60
- Working pressure in bar: 700
- Pressing width: thorn
- Cable lugs: standard Cu 10-240 • DIN AL 50-240
- Connectors: standard Cu 10-240 • DIN AL 50-240
- Pressing time, battery-operated in sec.: 6-12
- Battery charging time in min.: 30
- Battery type: Li-Ion, 18 V, 2 Ah



Art. no.	mm ²	dimension	kg	PU
216669-1	10 - 240	455 x 75 mm	7,270	1
216669-1-NO	10 - 240	455 x 75 mm	6,100	1
216669-1-N	10 - 240	455 x 75 mm	3,180	1

Akkuhydraulisches Presswerkzeug „SDE240-6M“ **Sensor**

Technical data and scope of delivery, see 216669-1.

With the different colours of the sensor LED, it shows whether the pressing has been completed successfully or which errors have occurred:

- Light is green: Pressing completed as standard, motor stopped.
- Light is orange: Battery voltage not sufficient
- Light is red: Pressing interrupted before completed

The device also has 1 white LED designed to illuminate the working area.



Art. no.	mm ²	dimension	kg	PU
216669/M-1	10 - 240	455 x 75 mm	7,280	1
216669/M-1-NO	10 - 240	455 x 75 mm	6,110	1
216669/M-1-N	10 - 240	455 x 75 mm	3,190	1

Scope of delivery for all battery-hydraulic cable cutters:
1 tool, 1 quick charger and 1 rechargeable battery in SysCon or system case incl. Insert.

For versions -NO: no battery, no charger
For versions -N: only machine in transport packaging

Hydraulic crimping tools

Battery powered crimping tool „SD300-6“

Crimping head can be rotated by 360°, manual return flow after perfect pressure, **quad-mandrel pressing**.

- Pressing force in kN: 60
- Working pressure in bar: 700
- Pressing width: thorn
- Cable lugs: standard Cu 16-300
- Connectors: standard Cu 16-120
- Pressing time, battery-operated in sec.: 6-12
- Battery charging time in min.: 30
- Battery type: Li-Ion, 18 V, 2 Ah



Art. no.	mm ²	dimension	kg	PU
216663-1	16 - 300	443 x 75 mm	7,970	1
216663-1-NO	16 - 300	443 x 75 mm	6,800	1
216663-1-N	16 - 300	443 x 75 mm	3,880	1

Battery powered crimping tool „SD300-6M“ Sensor

Technical data and scope of delivery, see 216663-1.

With the different colours of the sensor LED, it shows whether the pressing has been completed successfully or which errors have occurred:

- Light is green: Pressing completed as standard, motor stopped.
- Light is orange: Battery voltage not sufficient
- Light is red: Pressing interrupted before completed

The device also has 1 white LED designed to illuminate the working area.

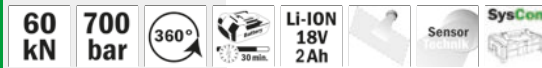

Art. no.	mm ²	dimension	kg	PU
216663/M-1	16 - 300	443 x 75 mm	8,280	1
216663/M-1-NO	16 - 300	443 x 75 mm	7,110	1
216663/M-1-N	16 - 300	443 x 75 mm	4,200	1

Test pin and gauge, see page 76.

Scope of delivery for all battery-hydraulic cable cutters:
1 tool, 1 quick charger and 1 rechargeable battery in SysCon or system case incl. Insert.

For versions -NO: no battery, no charger
For versions -N: only machine in transport packaging

Hydraulic hand pliers „HD300-6“

Crimping head can be rotated by 360°, manual return after completed pressing, light and compact construction in black plastic case.

- Pressing force in kN: 60
- Working pressure in bar: 700
- Cable lugs: standard Cu 16-300
- Connectors: standard Cu 16-120
- Dual-piston pump
- Weight in kg: 5,0
- Weight of set in kg: 6,5

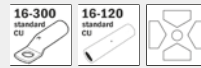

Art. no.	mm ²	dimension	kg	PU
216660	16 - 300	570 x 160 x 60 mm	6,500	1

Crimping headstock „KD300-6“

in plastic case.

- Pressing force in kN: 60
- Working pressure in bar: 700
- Cable lugs: standard Cu 16-300
- Connectors: standard Cu 16-120
- Quick coupling
- Weight in kg: 2,8
- Weight of set in kg: 3,8

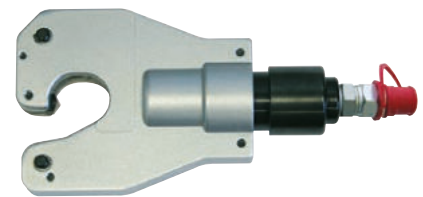

Art. no.	mm ²	dimension	kg	PU
216665	16 - 300	275 x 130 x 60 mm	3,800	1

Hydraulic quad-mandrel pressing tool for pressing ordinary conduit terminals and connectors, wide pressing. Reliable, robust, hydraulic pressing tool. The solution for your tough jobs!



- Tool adjusts automatically to the conductor cross-section being pressed
- Guaranteed DIN suitable connection
- No need to purchase further pressing inserts
- No need to change insert for each conductor cross-section
- Ideally suited for pressing extremely flexible finest-wired conductors of the cable classes 5 & 6
- Ideally suited to pressing of compacted conductors (no sleeve, no special cable shoe)
- Test thorn and guide for fast, simple, optical pressing pressure control

Note:
DIN pressing cable shoes must be processed in accordance with

haupa[®]

... convincing solutions

Hydraulic crimping tools

Battery powered crimping tool „SD400-6“

Crimping head can be rotated by 360°, manual return flow after perfect pressure, mandrel shape pressing.

- Pressing force in kN: 60
- Working pressure in bar: 700
- Head can be opened
- Cable lugs: standard Cu 25-400
- Connectors: standard Cu 25-400
- Pressing time, battery-operated in sec.: 6-12
- Battery charging time in min.: 30
- Battery type: Li-Ion, 18 V, 2 Ah



Art. no.	mm ²	dimension	kg	PU
216667-1	25 - 400	455 x 75 mm	8,070	1
216667-1-NO	25 - 400	455 x 75 mm	6,900	1
216667-1-N	25 - 400	455 x 75 mm	3,890	1

Battery powered crimping tool „SD400-6M“ Sensor

Technical data and scope of delivery, see 216667-1.

With the different colours of the sensor LED, it shows whether the pressing has been completed successfully or which errors have occurred:

- Light is green: Pressing completed as standard, motor stopped.
- Light is orange: Battery voltage not sufficient
- Light is red: Pressing interrupted before completed

The device also has 1 white LED designed to illuminate the working area.



Art. no.	mm ²	dimension	kg	PU
216667/M-1	25 - 400	455 x 75 mm	8,260	1
216667/M-1-NO	25 - 400	455 x 75 mm	7,090	1
216667/M-1-N	25 - 400	455 x 75 mm	4,170	1

Test pin

Test pin for hydraulic four mandrel pressing tools



Art. no.	kg	PU
216660/B	0,566	1

Hydraulic hand pliers „HD400-6“

Crimping head can be rotated by 360°, manual return after completed pressing, light and compact construction in black plastic case.

- Pressing force in kN: 60
- Working pressure in bar: 700
- Head can be opened
- Cable lugs: standard Cu 25-400
- Connectors: standard Cu 25-400
- Dual-piston pump
- Weight in kg: 5,2
- Weight of set in kg: 6,7

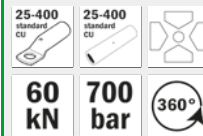

Art. no.	mm ²	dimension	kg	PU
216661	25 - 400	585 x 160 x 75 mm	6,700	1

Crimping headstock „HKD400“

in plastic case.

- Pressing force in kN: 60
- Working pressure in bar: 700
- Head can be opened
- Cable lugs: standard Cu 25-400
- Connectors: standard Cu 25-400
- Quick coupling
- Weight in kg: 3
- Weight of set in kg: 4

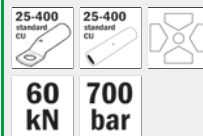

Art. no.	mm ²	dimension	kg	PU
216666	25 - 400	300 x 136 x 82 mm	4,000	1

Template for four mandrel pressing

Template for hydraulic four mandrel pressing tools to be used in connection with 216660/B



Art. no.	kg	PU
216660/L	0,566	1

Pressure testing tool

Hydraulic hand pliers „HDE500-12“

Crimping headstock 180° rotatable, no dies necessary, single-mandrel crimp.

- Pressing force in kN: 120
- Working pressure in bar: 700
- Hinged head
- Cable Lugs: standard Cu 35-500 • DIN AL 95-500
- Connectors: standard Cu 35-500 • DIN AI 95-500 • DIN 46234
- Weight in kg: 7,7



60 kN
700 bar
360°

Art. no.	mm ²	kg	PU
216691	35 - 500	7,700	1

Battery powered crimping tool „ADE500-12M“ **Sensor**

With the different colours of the sensor LED, it shows whether the pressing has been completed successfully or which errors have occurred.

- Pressing force in kN: 120
- Working pressure in bar: 700
- Hinged Head
- Cable Lugs: standard Cu 35-500 • DIN AL 95-500
- Connectors: standard Cu 35-500 • DIN AI 95-500 • DIN 46234
- Pressing time, battery-operated in sec.: 6-12
- Battery charging time in min: 60
- Battery type: Li-Ion, 18 V, 4 Ah



Art. no.	TL	mm ²	kg	PU
216668/M-1	450	35 - 500	11,430	1
216668/M-1-NO	450	35 - 500	9,700	1
216668/M-1-N	450	35 - 500	6,780	1

Headstock „KDE500-12“

- Pressing force in kN: 120
- Working pressure in bar: 700
- Hinged Head
- Cable Lugs: standard Cu 35-500 • DIN AL 95-500
- Connectors: standard Cu 35-500 • DIN AI 95-500 • DIN 46234
- Weight in kg: 3,5

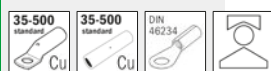

120 kN
700 bar
360°

Art. no.	mm ²	kg	PU
216690	35 - 500	3,500	1

Pressure testing tool C-head

Dies and indicating manometer for monitoring the pressing force of article 216601, 216124, 216004, 216622, 216125, 216005



400-C12

Art. no.	kg	PU
217100	1,900	1

Pressure testing tool pistol-format

Dies and indicating manometer for monitoring the pressing force, only for battery-operated pressing tools in the 400-C12 and 216800 series



400-C12

Art. no.	kg	PU
217101	0,800	1

Pressure testing tool H-head

Dies and indicating manometer for monitoring the pressing force of article 215946, 215980, 216503



400-C12

Art. no.	kg	PU
217102	5,000	1

Pressure testing tool O-head

Dies and indicating manometer for monitoring the pressing force of article 216801-1, 216801/M-1, 216800, 216802, 216804, 216807



300-06

Art. no.	kg	PU
217103	2,000	1

Pressure testing tool 240-H6

Dies and indicating manometer for monitoring the pressing force of article 215881-1, 215881/M-1, 215800



240-H6

Art. no.	kg	PU
217104	3,400	1

Pressure testing tool 185-H6

Dies and indicating manometer for monitoring the pressing force of article 215765-1, 215770-1, 215770/M-1



185-H6

Art. no.	kg	PU
217105	3,300	1

Pressure testing tool recorder **Sensor**

for all accumulator hydraulics with sensor technology



Art. no.	kg	PU
217107	0,700	1

Accessories

Battery Li-Ion 18 V 2 Ah

Compatible with all Li-Ion 18 V battery devices

- Intelligent battery monitoring, temperature protection, LED capacity indicator
- Charging possible using the HAUPA compact charger item 215527 or original Makita charging technology
- Please note: This battery cannot be charged using the HAUPA quick charger item 215513.



Art. no.	kg	PU
215523	0,350	1

Battery Li-Ion 18 V 4 Ah

Compatible with all Li-Ion 18 V battery devices

- intelligent battery monitoring, temperature protection, LED capacity indicator
- Charging possible using the HAUPA compact charger item 215527 or original Makita charging technology
- Please note: This battery cannot be charged using the HAUPA quick charger item 215513.



Art. no.	kg	PU
215525	0,580	1

Li-Ion 18 V compact charger

For battery models 215503, 215511, 215523, 215525



Art. no.	kg	PU
215527	0,126	1

Battery Li-Ion 18 V 2 Ah

compatible with all Li-Ion, 18 Volt Battery powered tools build before 2018



Art. no.	kg	PU
215503	0,383	1

Battery Li-Ion 18 V 4 Ah

compatible with all Li-Ion, 18 Volt Battery powered tools build before 2018



Art. no.	kg	PU
215511	0,651	1

Quick charger Li-Ion 18 V

for art. 215503, 215511



Art. no.	kg	PU
215513	0,819	1

Hydraulic oil

0,5 l



Art. no.	kg	PU
216254	1,000	1

18V Battery Adapter

Useful adapter for the use of Bosch-, Milwaukee- or Dewalt Batteries with HAUPA Battery powered tools.

- with sliding connection



Art. no.	Adapter for	kg	PU
215529	Bosch	0,350	1
215531	Milwaukee	0,350	1
215533	Dewalt	0,350	1

Scope of delivery for all battery-hydraulic cable cutters:
1 tool, 1 quick charger and 1 rechargeable battery in SysCon or system case incl. Insert.

For versions -NO: no battery, no charger
For versions -N: only machine in transport packaging

Hydraulic crimping headstocks

Hydraulic crimping headstock „KH-25“

for uninsulated terminals 95 - 630 mm², pressure 250 kN, for crimping dies hexagon shape according to DIN 48083 page 3 and 4.

- Pressing force in kN: 250
- Working pressure in bar: 700
- Pressing area Cu/Al: 95-630
- Quick coupling
- Weight in kg: 6,4
- Weight of set in kg: 9



Art. no.	TL	mm ²	kg	PU
216236	185	95 - 630	9,000	1

Crimping dies DIN-connection, Cu/Al

hexagon pressing dies according DIN 48083 page 4 suitable for DIN-connection material according to DIN. Cu ze (free of tensile)



630-H250



Art. no.	mm ²	Al	ld.	kg	PU
212372	95	70	18	1,340	1
212376	120	-	20	1,340	1
212380	150	95 - 120	22	1,335	1
212382	185	150	25	1,325	1
212384	240	185	28	1,250	1
212388	300	240	32	1,275	1
212390	300	300	34	1,180	1
212392	400	400	38	1,160	1
212394	500	-	42	1,110	1
212396	625	500	44	1,100	1

Crimping dies, standard, Cu

standard, hexagonal pressing



630-H250



Art. no.	Cu	kg	PU
212580	95	1,340	1
212581	120	1,340	1
212582	150	1,335	1
212583	185	1,325	1
212584	240	1,250	1
212585	300	1,275	1
212586	400	1,160	1
212587	500	1,110	1
212588	625	1,100	1

Hydraulic crimping headstock set

Content: Art. No. 216236 Hydraulic crimping headstock, Art. No. 216238 Hydraulic high-pressure hose, 2 m, Art. No. 216348 Hydraulic foot pump, Art. No. 216251 Carrycase.

- Pressing force in kN: 250
- Working pressure in bar: 700
- Opening/ Hub: Pin
- Pressing width: wide
- Pressing area Cu/Al: 95-630
- Dual-piston pump
- Quick coupling
- Weight in kg: 18,4
- Weight of set in kg: 21

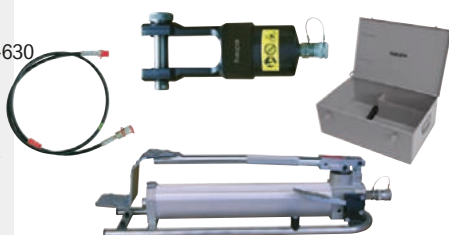
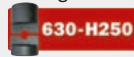

Art. no.	mm ²	kg	PU
216250	95 - 630	21,000	1

Hydraulic crimping headstock + cylinder „KH-45“

for terminals and butt connectors to 1000 mm², together with an adapter it is possible to use all other crimping dies of the other crimping headstock, low weight in comparison to the crimping range, excellent price relation, snap head, extensionable system to bend and punch electric bus bars socket-joint connection.

- Pressing force in kN: 450
- Working pressure in bar: 700
- Pressing width: wide
- Pressing area Cu/Al: 120-1000
- Quick coupling
- Weight of set in kg: 13,5



Art. no.	TL	mm ²	kg	PU
216355	185	120 - 1000	13,500	1

Crimping dies, standard

standard, hexagonal pressing



1000-H450



Art. no.	mm ²	kg	PU
216304	120	2,635	1
216306	150	2,600	1
216308	185	2,620	1
216310	240	2,580	1
216312	300	2,580	1
216314	400	2,235	1
216316	500	2,300	1
216318	625	2,300	1

Crimping dies, DIN

DIN, hexagonal pressing for terminals and connectors DIN 46235 and for Al terminals and Al connectors



1000-H450



Art. no.	mm ²	Al	ld.	kg	PU
216320	120	-	20	2,635	1
216322	150	95 - 120	22	2,600	1
216324	185	150	25	2,620	1
216326	240	185	28	2,580	1
216328	300	240	32	2,580	1
216330	300	300	34	2,235	1
216332	400	-	38	2,300	1
216334	500	-	42	2,300	1
216336	625	-	44	2,300	1
216338	800	-	52	2,300	1
216340	1000	-	58	2,040	1

haupa®

... convincing solutions

Pumps for hydraulic crimping headstocks

Hydraulic foot pump „F-700“

material: aluminium alloy, light design, twin-cam pump, automatic switching from closing (ca. 25 ccm/Hub) to working feed rate (ca. 2.5 ccm/Hub), security valve, max. working pressure 700 bar (+ 10/- 30 bar), without hose, **with quick coupling**



Art. no.	NP	kg	PU
216348	700	12,000	1

Hydraulic high-pressure hose

steel-reinforced with rapid coupling to foot pump art. 216348 and electro-hydraulic pump art. 216352



Art. no.	m	kg	PU
216364	5	1,260	1

Electro-hydraulic pump „PN700 I“

electric foot switch, completely self-acting, also the release of the dies at the end of the operation, 2 m high pressure tube and hydraulic connectors, for industrial uses, where a high level of production is needed, 230 volt, with foot switch control, pump for working outside



Art. no.	NP	kg	PU
216352	700 230V	20,000	1

Battery-hydraulic pump „PA-700“

Sensor

2 stage hydraulics, manual control switch, manual return flow after perfect pressure, LED for battery control, 1 quick charger, 1 battery Li-Ion, 4 Ah, carrying belt, max. operating pressure: 700 bar with 1,8 m hose, **with quick coupling**.

With the different colours of the sensor LED, it shows whether the pressing has been completed successfully or which errors have occurred:

- Light is green: Pressing completed as standard, motor stopped.
- Light is orange: Battery voltage not sufficient
- Light is red: Pressing interrupted before completed

Cutting/Pressing/Punching





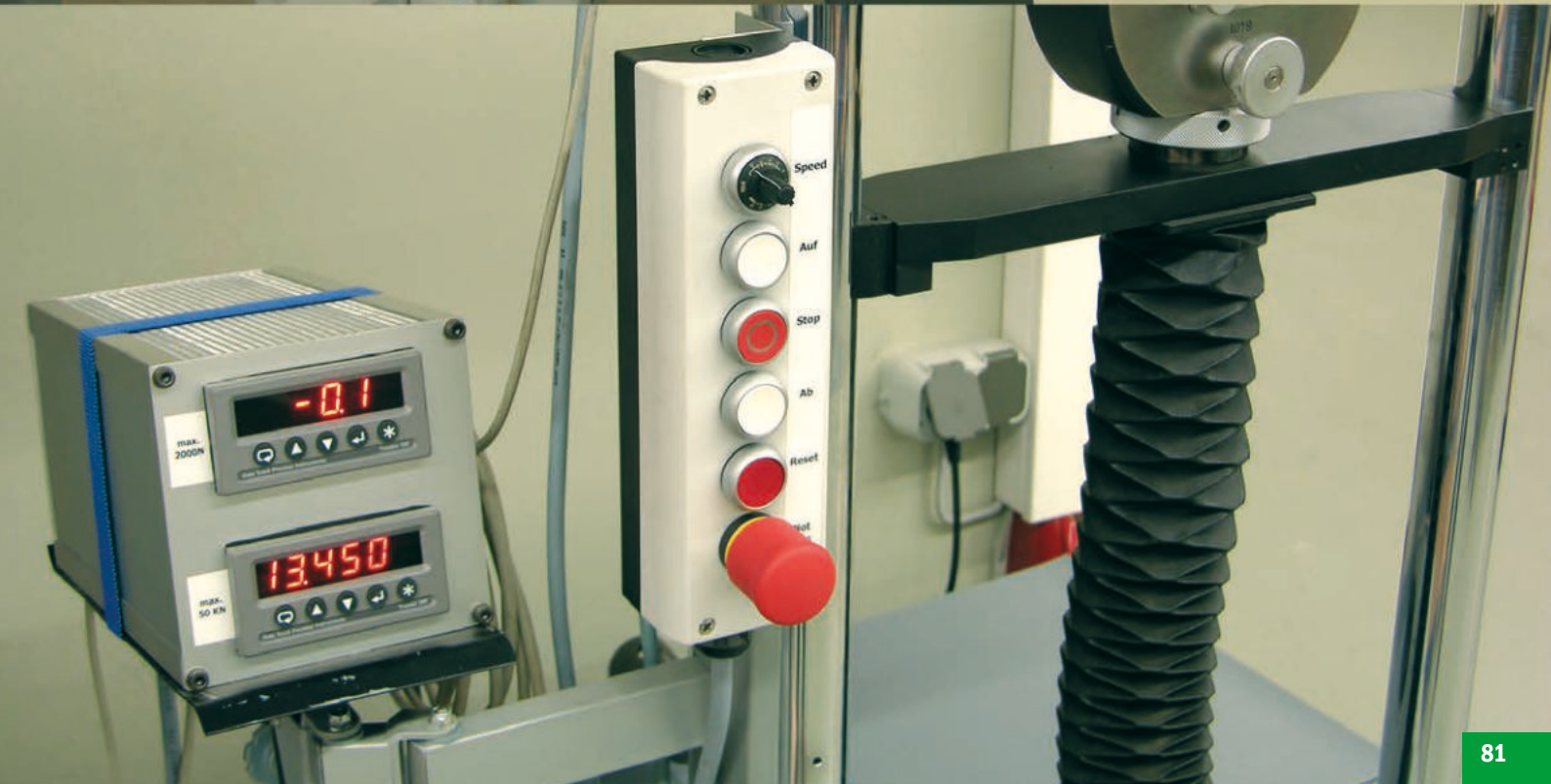
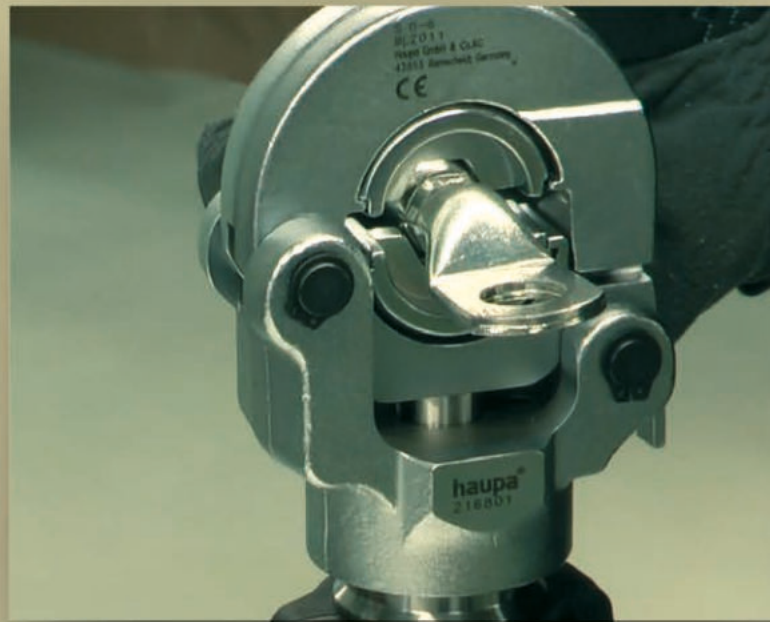
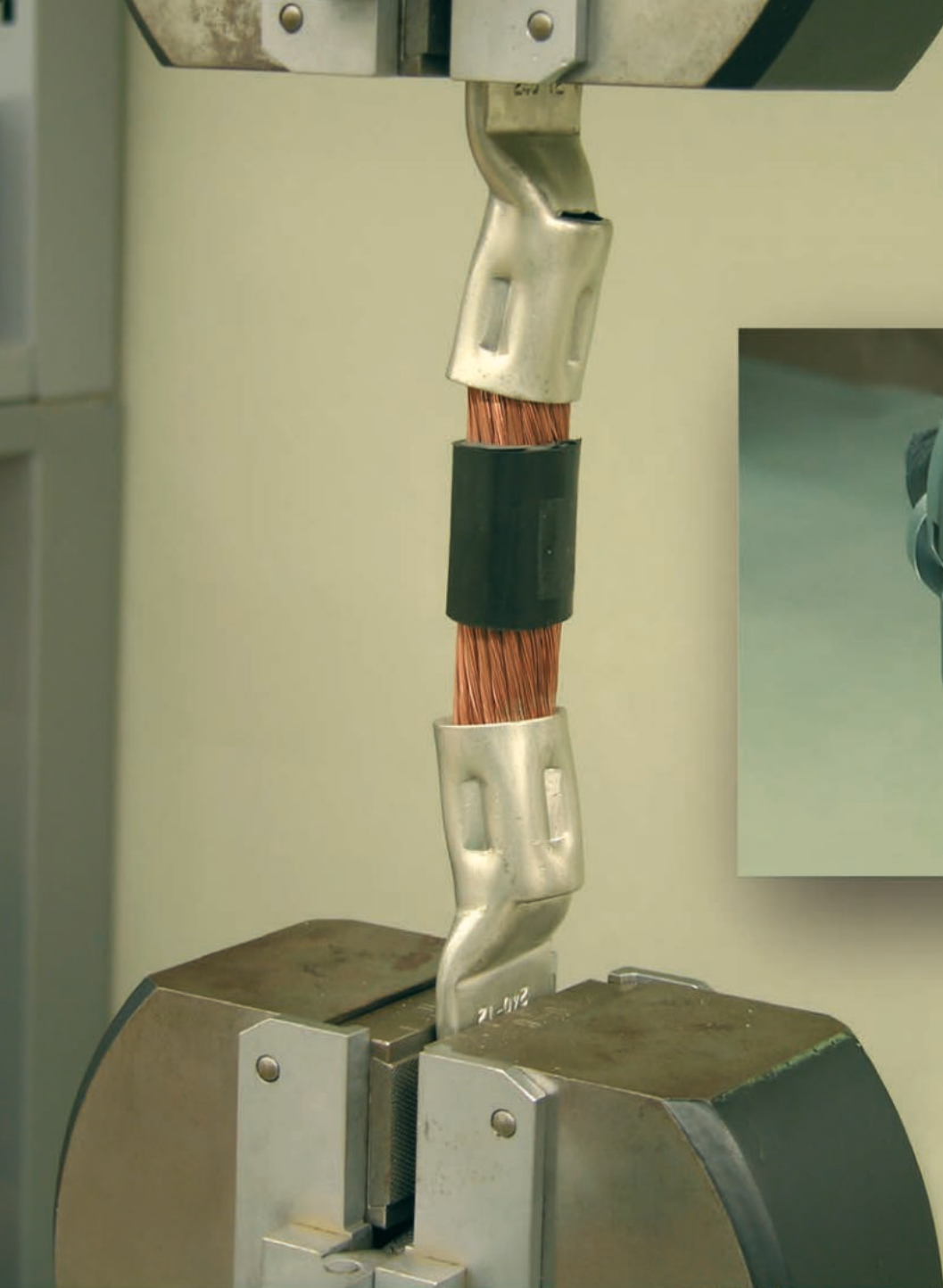







Art. no.	NP	kg	PU
216357	700 Akku	8,000	1



6 tonne pressing tools

Tool	Article No.	Type	Insert range	Pressing width	Sensor technology	Pressing width thorn	Pressing force kN	Working pressure in bar	Head can be opened	Quick coupling	HUB/ opening mm	Pressing range for cable lugs						Pressing range for connectors						kg	Set kg	Battery	Pressing time in sec.			
												Cu	Cu DIN	F-Type	AI DIN	CU standard PL	CU standard light T	Cu	Cu DIN	F-Type	AI DIN	Cu standard PL	Cu standard light M					Dual piston pump		
	215765	HHs-6	185 H6	slim	-	-	60	700	●	-	17	10-240	10-185	-	10-185	10-185	10-185	10-185	10-185	10-185	10-185	10-185	10-185	10-185	10-185	10-185	3,000	7,900	-	-
	215770-1	SHs-6	185 H6	slim	-	-	60	700	●	-	17	10-240	10-185	-	10-240	10-240	10-240	10-240	10-240	10-240	10-240	10-240	10-240	10-240	10-240	10-240	2,400	7,900	Li-Ion 18V 1,5 Ah	5
	215770/M-1	SHs-6	185 H6	slim	●	-	60	700	●	-	17	10-240	10-185	-	10-240	10-240	10-240	10-240	10-240	10-240	10-240	10-240	10-240	10-240	10-240	10-240	2,400	7,900	Li-Ion 18V 1,5 Ah	5
	215800	HH-6	240 H6	slim	-	-	60	700	●	-	17	10-240	10-240	-	10-240	10-240	10-240	10-240	10-240	10-240	10-240	10-240	10-240	10-240	10-240	10-240	3,000	4,500	-	-
	215881-1	SH-6	240 H6	slim	-	-	60	700	●	-	17	10-240	10-240	-	10-240	10-240	10-240	10-240	10-240	10-240	10-240	10-240	10-240	10-240	10-240	10-240	2,400	7,900	Li-Ion 18V 1,5 Ah	5
	215881/M-1	SH-6	240 H6	slim	●	-	60	700	●	-	17	10-240	10-240	-	10-240	10-240	10-240	10-240	10-240	10-240	10-240	10-240	10-240	10-240	10-240	10-240	2,400	7,900	Li-Ion 18V 1,5 Ah	5
	216807	KO-6	300 O6	slim	-	-	60	700	●	●	17	6-300	6-300	6-300	6-300	6-300	6-300	6-300	6-300	6-300	6-300	6-300	6-300	6-300	6-300	6-300	3,200	4,200	-	-
	216804	HO-6	300 O6	slim	-	-	60	700	●	-	17	6-300	6-300	6-300	6-300	6-300	6-300	6-300	6-300	6-300	6-300	6-300	6-300	6-300	6-300	6-300	8,100	11,800	-	-
	215802	HO-6	300 O6	slim	-	-	60	700	●	-	17	6-300	6-300	6-300	6-300	6-300	6-300	6-300	6-300	6-300	6-300	6-300	6-300	6-300	6-300	6-300	3,500	5,000	-	-
	215801-1	SO-6	300 O6	slim	-	-	60	700	●	-	17	6-300	6-300	6-300	6-300	6-300	6-300	6-300	6-300	6-300	6-300	6-300	6-300	6-300	6-300	6-300	2,400	7,900	Li-Ion 18V 1,5 Ah	5
	215801/M-1	SO-6	300 O6	slim	●	-	60	700	●	-	17	6-300	6-300	6-300	6-300	6-300	6-300	6-300	6-300	6-300	6-300	6-300	6-300	6-300	6-300	6-300	2,400	7,900	Li-Ion 18V 1,5 Ah	5
	216800/M	AO-6	300 O6	slim	●	-	60	700	●	-	17	6-300	6-300	6-300	6-300	6-300	6-300	6-300	6-300	6-300	6-300	6-300	6-300	6-300	6-300	6-300	4,500	9,500	Li-Ion 18V 3 Ah	4
	216665	KD300-6		wide	-	●	60	700	-	●	-	16-300	16-300	16-300	16-120	16-300	16-95	16-95	16-120	16-120	16-120	16-120	16-120	16-120	16-120	16-120	2,800	3,800	-	-
	216660	HD300-6		wide	-	●	60	700	-	-	-	16-300	16-300	16-300	16-120	16-300	16-95	16-95	16-120	16-120	16-120	16-120	16-120	16-120	16-120	5,000	6,500	-	-	
	216663/M-1	AD300-6		wide	●	●	60	700	-	-	-	16-300	16-300	16-300	16-120	16-300	16-95	16-95	16-120	16-120	16-120	16-120	16-120	16-120	16-120	4,500	9,500	Li-Ion 18V 1,5 Ah	6	
	216666	KD400-6		wide	-	●	60	700	●	●	-	25-400	25-400	25-400	25-400	25-400	25-400	25-400	25-400	25-400	25-400	25-400	25-400	25-400	25-400	3,000	4,000	-	-	
	216661	HD400-6		wide	-	●	60	700	●	-	-	25-400	25-400	25-400	25-400	25-400	25-400	25-400	25-400	25-400	25-400	25-400	25-400	25-400	25-400	5,200	6,700	-	-	
	216667/M-1	AD400-6		wide	●	●	60	700	●	-	-	25-400	25-400	25-400	25-400	25-400	25-400	25-400	25-400	25-400	25-400	25-400	25-400	25-400	25-400	4,800	9,800	Li-Ion 18V 1,5 Ah	6	
	216669/M-1	SDE240-6		wide	●	●	60	700	●	-	-	6-240	6-240	6-240	6-240	6-240	6-240	6-240	6-240	6-240	6-240	6-240	6-240	6-240	6-240	6-240	2,900	7,900	Li-Ion 18V 1,5 Ah	5

12 tonne pressing tools

Tool	Article No.	Type	Insert range	Pressing width	Sensor technology	Pressing force kN	Working pressure in bar	Head can be opened	Quick coupling	HUB/ opening mm	Pressing range for cable lugs										Pressing range for connectors						Dual piston pump	kg	Set kg	Battery	Pressing time in sec.			
											Cu	Cu DIN	F-Type	Al DIN	CU standard PL	CU standard light T	Cu	Cu DIN	F-Type	Al DIN	Cu standard PL	Cu standard light M	Groove pressing	Cu	Cu DIN	F-Type						Al DIN	Cu standard PL	Cu standard light M
	216004	KC25-12	400 C12	wide	-	120	700	-	●	25	Cu 10-400	Cu DIN 10-300	F-Type 10-300	Al DIN 16-240	CU standard PL 10-400	CU standard light T 10-300	Cu 10-185	Cu DIN 10-150	F-Type 10-150	Al DIN 16-120	Cu standard PL 10-185	Cu standard light M 10-150	-	Cu 10-185	Cu DIN 10-150	F-Type 10-150	Al DIN 16-120	Cu standard PL 10-185	Cu standard light M 10-150	-	3,600	4,600	-	-
	216124	HC25-12	400 C12	wide	-	120	700	-	-	25	Cu 10-400	Cu DIN 10-300	F-Type 10-300	Al DIN 16-240	CU standard PL 10-400	CU standard light T 10-300	Cu 10-185	Cu DIN 10-150	F-Type 10-150	Al DIN 16-120	Cu standard PL 10-185	Cu standard light M 10-150	-	Cu 10-185	Cu DIN 10-150	F-Type 10-150	Al DIN 16-120	Cu standard PL 10-185	Cu standard light M 10-150	-	6,200	7,700	-	-
	216601	AC25-12	400 C12	wide	●	120	700	-	-	25	Cu 10-400	Cu DIN 10-300	F-Type 10-300	Al DIN 16-240	CU standard PL 10-400	CU standard light T 10-300	Cu 10-185	Cu DIN 10-150	F-Type 10-150	Al DIN 16-120	Cu standard PL 10-185	Cu standard light M 10-150	-	Cu 10-185	Cu DIN 10-150	F-Type 10-150	Al DIN 16-120	Cu standard PL 10-185	Cu standard light M 10-150	-	7,000	12,000	Li-Ion 18V 1,5 Ah	6
	216005	KC42-12	400 C12	wide	-	120	700	-	●	42	Cu 10-400	Cu DIN 10-300	F-Type 10-300	Al DIN 16-240	CU standard PL 10-400	CU standard light T 10-300	Cu 10-400	Cu DIN 10-300	F-Type 10-300	Al DIN 16-240	Cu standard PL 10-400	Cu standard light M 10-300	-	Cu 10-400	Cu DIN 10-300	F-Type 10-300	Al DIN 16-240	Cu standard PL 10-400	Cu standard light M 10-300	-	5,300	6,300	-	-
	216125	HC42-12	400 C12	wide	-	120	700	-	-	42	Cu 10-400	Cu DIN 10-300	F-Type 10-300	Al DIN 16-240	CU standard PL 10-400	CU standard light T 10-300	Cu 10-400	Cu DIN 10-300	F-Type 10-300	Al DIN 16-240	Cu standard PL 10-400	Cu standard light M 10-300	-	Cu 10-400	Cu DIN 10-300	F-Type 10-300	Al DIN 16-240	Cu standard PL 10-400	Cu standard light M 10-300	-	8,200	9,700	-	-
	216622	AC42-12	400 C12	wide	●	120	700	-	-	42	Cu 10-400	Cu DIN 10-300	F-Type 10-300	Al DIN 16-240	CU standard PL 10-400	CU standard light T 10-300	Cu 10-400	Cu DIN 10-300	F-Type 10-300	Al DIN 16-240	Cu standard PL 10-400	Cu standard light M 10-300	-	Cu 10-400	Cu DIN 10-300	F-Type 10-300	Al DIN 16-240	Cu standard PL 10-400	Cu standard light M 10-300	-	8,500	13,000	Li-Ion 18V 1,5 Ah	7
	215980	KH-12	400 C12	wide	-	120	700	●	●	20	Cu 10-400	Cu DIN 10-300	F-Type 10-300	Al DIN 16-240	CU standard PL 10-400	CU standard light T 10-300	Cu 10-400	Cu DIN 10-300	F-Type 10-300	Al DIN 16-240	Cu standard PL 10-400	Cu standard light M 10-300	●	Cu 10-400	Cu DIN 10-300	F-Type 10-300	Al DIN 16-240	Cu standard PL 10-400	Cu standard light M 10-300	-	4,000	5,000	-	-
	215946	HH-12	400 C12	wide	-	120	700	●	-	20	Cu 10-400	Cu DIN 10-300	F-Type 10-300	Al DIN 16-240	CU standard PL 10-400	CU standard light T 10-300	Cu 10-400	Cu DIN 10-300	F-Type 10-300	Al DIN 16-240	Cu standard PL 10-400	Cu standard light M 10-300	●	Cu 10-400	Cu DIN 10-300	F-Type 10-300	Al DIN 16-240	Cu standard PL 10-400	Cu standard light M 10-300	-	6,000	7,500	-	-
	216503	AH-12	400 C12	wide	●	120	700	●	-	20	Cu 10-400	Cu DIN 10-300	F-Type 10-300	Al DIN 16-240	CU standard PL 10-400	CU standard light T 10-300	Cu 10-400	Cu DIN 10-300	F-Type 10-300	Al DIN 16-240	Cu standard PL 10-400	Cu standard light M 10-300	●	Cu 10-400	Cu DIN 10-300	F-Type 10-300	Al DIN 16-240	Cu standard PL 10-400	Cu standard light M 10-300	-	7,000	12,000	Li-Ion 18V 1,5 Ah	6
	216236	KH-25	630 - H250	wide	-	250	700	●	●	20	-	95-630	-	70-500	-	-	-	-	95-630	-	70-500	-	-	-	-	-	-	-	-	-	6,400	9,000	-	-
	216355	KH-45	1000 - H450	wide	-	450	700	●	●	-	120-625	120-1000	-	95-300	120-625	-	120-625	120-1000	-	120-625	120-1000	-	-	-	-	-	-	-	-	10,300	13,500	-	-	

Hydraulic punching tools



Hydraulic punching tools

Hydraulic hand-punching tool „HS-8“

Punches precise holes with almost no burring. Ideal for fast, frontal punching of control panels.

Extent of supply: 1 hydraulic hand punch, 1 connecting rod 3/8-24 UNF (article no. 217660), 1 connecting rod 3/4-16 UNF (article no. 217662), 1 adapter (article no. 217664), 1 spacer bushing (article no. 217666), 1 transport case.

- Punching performance: Steel sheet of up to a maximum of 3 mm
- Pressing force: 80 kN
- Length: 308 mm
- Weight: 2,4 kg
- Weight Set: 3,8 kg



**80
kN**

Art. no.	kg	PU
217604	3,800	1

Hydraulic hand-punch-cutter „HS-6“

Punches accurate slugs nearly free of burs. Usable for building and maintaining control boxes, for car retrofitting and for sanitary application.

Extent of supply: 1 hydraulic punching tool, 1 rod 3/8-24 UNF (art. 217660), 1 rod 3/4-16 UNF (art. 217662), 1 adapter (art. 217664), 1 sleeve (art. 217666), 1 plastic case with insert.

- Punching capacity: Steel plates up to max. 3 mm
- Pressing force: 60 kN
- Length: 230 mm
- Weight: 2,4 kg
- Weight Set: 3,8 kg



**60
kN**

Art. no.	kg	PU
217602	3,800	1

Punching dies, metric

- ST37, 3 mm

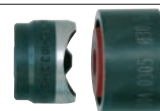

Art. no.	Ø		Connecting rod	kg	PU
217610	16,5	ISO 16	217660	0,070	1
217612	20,5	ISO 20	217660	0,090	1
217614	25,5	ISO 25	217660	0,150	1
217616	32,5	ISO 32	217660	0,220	1
217618	40,5	ISO 40	217662	0,900	1
217620	50,5	ISO 50	217662	0,640	1
217622	63,5	ISO 63	217662	0,950	1

Punching dies, PG

- ST37, 3 mm

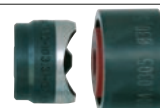

Art. no.	Ø		Connecting rod	kg	PU
217630	15,2	PG9	217660	0,060	1
217632	18,6	PG11	217660	0,084	1
217634	20,4	PG13,5	217660	0,091	1
217636	22,5	PG16	217660	0,120	1
217638	28,3	PG21	217660	0,170	1
217640	37	PG29	217662	0,330	1
217642	47	PG36	217662	0,536	1
217644	54	PG42	217662	0,731	1
217646	60	PG48	217662	0,896	1

Punching dies, square

- ST37, 2,5 mm
- UNF



Art. no.	width/height	kg	PU
217650	46	1,862	1
217652	68	1,500	1
217654	92	2,000	1

Connecting rod

Art. 217660 - 3/8-24 UNF

Art. 217662 - 3/4-16 UNF



Art. no.		kg	PU
217660	1	0,040	1
217662	2	0,203	1

Adapter

for connecting rod art. 217660

- UNF

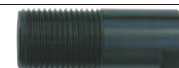

Art. no.	kg	PU
217664	0,100	1

Spacer bushing



Art. no.	kg	PU
217666	0,100	1

The corresponding punching head "U-S-6" (Art. no. 216764) and adapter for pumps (Art. no. 216765) can be found on P. 61.

Punch and bending centre

Basic unit

Basic unit to accommodate bending, hole-making, cutting and cranking tools. The processing of lamellar copper rails is possible! Hydraulic tool for connection to a hydraulic pump with 700 bar (10,000 PSI).

The universal tool system is particularly suited for use in workshops and on building sites. Copper and aluminium rails can be processed up to dimension of 12 x 120 mm. The changing of the individual tools is carried out in seconds thanks to the user-friendly construction. The compact construction and light weight enable transportation in any car.

Bending:

Thanks to an integrated proximity switch a 100% repeat accuracy is achieved. The maximum bending angle is 110°.

Hole-making:

The height-adjustable table with side stopper makes working easier. Marking out and measuring is not necessary. Holes from 6.5 to 21.0 mm in diameter can be punched. Slotted holes up to 14 x 20 mm. With the hole tool II holes can be made in lamellar copper rails and grounding bands.

Cutting:

Our cutting blade geometry enables clean and burr-free cutting.

Cranking:

The offsetting (stepped bending) by a material thickness is carried out in a single process.

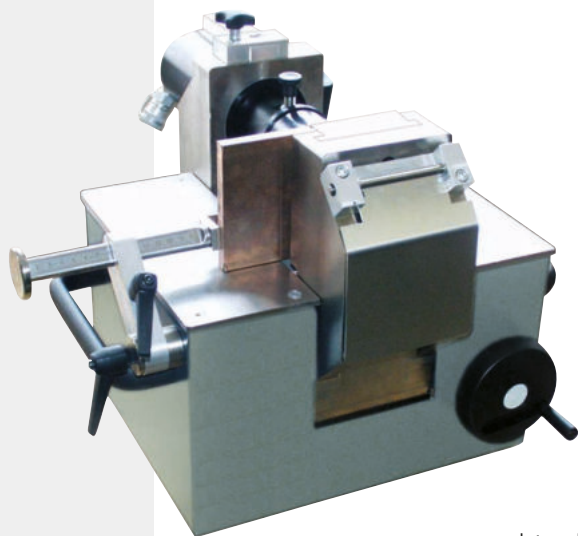

Art. no.	kg	PU
216770	51,000	1

Hole-making tools

For punching round and slotted holes.

- Maximum material thickness: 12 mm
- Maximum diameter: 21 mm
- Maximum slotted hole: 17 x 20 mm

216776:

Hole tool for solid copper and aluminium rails

216777:

Hole-making tool for solid copper and aluminium rails as well as for laminated copper rails and grounding bands

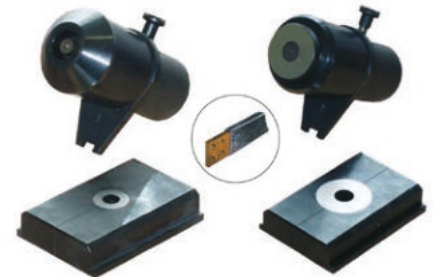

Art. no.	kg	PU
216776	4,300	1
216777	4,300	1

Hole inserts for round holes

For both hole-making tools, the following diameters can be supplied

Art. no.	Ø		kg	PU
216778	6,5	M6 > 216776	0,118	1
216778/L	6,5	M6 > 216777	0,421	1
216779	9,0	M8 > 216776	0,114	1
216779/L	9,0	M8 > 216777	0,420	1
216780	10,5	M8 > 216776	0,110	1
216780/L	10,5	M8 > 216777	0,419	1
216781	11,0	M10 > 216776	0,106	1
216781/L	11,0	M10 > 216777	0,418	1
216782	12,7	M10 > 216776	0,102	1
216782/L	12,7	M10 > 216777	0,416	1
216783	13,0	M12 > 216776	0,098	1
216783/L	13,0	M12 > 216777	0,414	1
216784	17,0	M16 > 216776	0,094	1
216784/L	17,0	M16 > 216777	0,412	1
216785	21,0	M20 > 216776	0,090	1
216785/L	21,0	M20 > 216777	0,411	1

Hole inserts for slotted holes

For both hole-making tools, the following diameters can be supplied

Art. no.	Ø		kg	PU
216786	9 x 18	M8 > 216776	0,098	1
216786/L	9 x 18	M8 > 216777	0,423	1
216787	11 x 20	M10 > 216776	0,095	1
216787/L	11 x 20	M10 > 216777	0,421	1
216788	13 x 20	M12 > 216776	0,092	1
216788/L	13 x 20	M12 > 216777	0,419	1
216789	17 x 20	M16 > 216776	0,089	1
216789/L	17 x 20	M16 > 216777	0,417	1



haupa®

... convincing solutions

Bending tool

for bending of solid copper or aluminium rails up to 12 x 120 mm. The bending matrix suits all bending radii

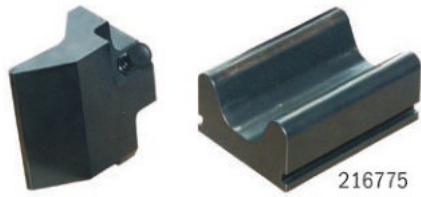

Art. no.		kg	PU
216772	8	4,100	1
216775	universal (counterholder)	3,200	1

Cutting tool

for separating solid copper and aluminium rails up to 12 x 120 mm

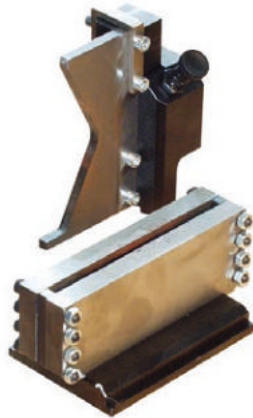

Art. no.	mm	kg	PU
216790	12 x 120	5,500	1

Cutting tool for lamellar rails

for separating lamellar rails made from copper, maximum dimensions: 12 x 120 mm



Art. no.	mm	kg	PU
216791	12 x 120	9,000	1

Cranking tool for stepped bending of power rails

for creating a material offset in rail thicknesses on a length of just 30 mm. Possible offset 5, 6, 8, 10 and 12 mm

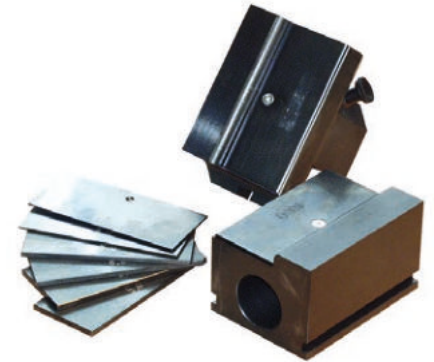

Art. no.		kg	PU
216792		10,000	1

Tool cases

stable metal sheet case for accommodation of hole-making tool with inserts (1) or two tools (2)

Art. no.	numbers	kg	PU
216793	1	2,000	1
216794	2	2,000	1

Electro-hydraulic pump „Special“

electric foot switch, completely self-acting, also the release of the dies at the end of the operation, 2 m high pressure tube and hydraulic connectors, for industrial uses, where a high level of production is needed, 230 volt, with foot switch control, pump for working outside



Art. no.		kg	PU
216359	230V	22,000	1

Fish tapes
Cable pulling device system

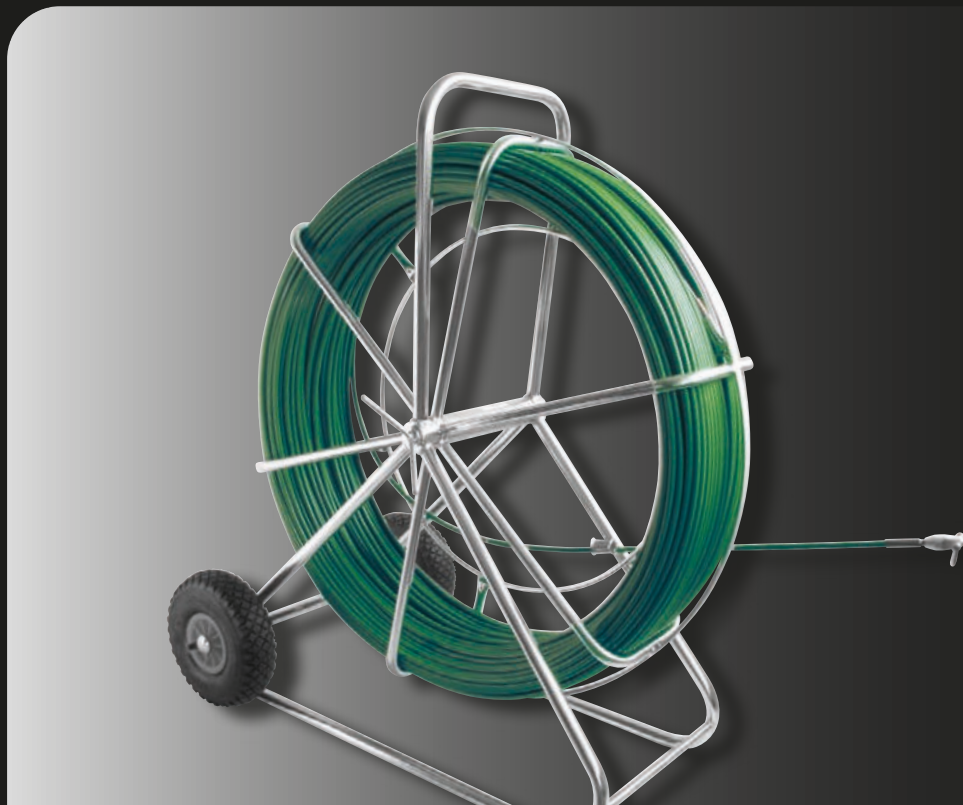

Fish tapes

Steel fish tapes

with eyelet and brass rolling ball, without additional pilot spring

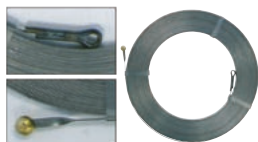

Art. no.	TL	Ø	kg/100	PU	PE
150152	10	3,5	13,100	1	1
150154	15	3,5	20,800	1	1
150156	20	3,5	26,800	1	1
150158	25	3,5	32,300	1	1

Spiral fish tapes

made from steel spirals, fourfold twisted, with solid steel end pieces, strip size 4 mm



Art. no.	TL	Ø	kg/100	PU	PE
150200	5	4	31,200	1	1
150202	10	4	69,100	1	1
150204	15	4	98,800	1	1
150206	20	4	134,300	1	1
150208	25	4	182,000	1	1
150210	30	4	185,900	1	1

Perlon fish tapes

made from stretched „Bayer-Perlon wire“, black, with solid steel end pieces, with additional pilot spring, approx. 120 mm length



Art. no.	TL	Ø	kg/100	PU	PE
150220 *	5	3	6,000	1	1
150222 *	10	3	10,300	1	1
150224 *	15	3	14,100	1	1
150226 *	20	3	18,800	1	1
150228	25	3	24,600	1	1
150230	30	3	24,400	1	1
150241 *	10	4	16,000	1	1
150243 *	15	4	23,400	1	1
150245 *	20	4	30,300	1	1
150247 *	25	4	38,600	1	1

Perlon fish tapes

made from stretched „Bayer-Perlon wire“, black, with solid steel end pieces, without additional pilot spring, strip size 4 mm



Art. no.	TL	Ø	kg/100	PU	PE
150232	10	4	15,200	1	1
150234	15	4	23,600	1	1
150236	20	4	30,300	1	1
150238	25	4	40,200	1	1
150239	30	4	44,500	1	1

Perlon fish tapes

made from stretched „Bayer-Perlon wire“, black, with solid steel end pieces, with 2 eyes, strip size 3 mm



Art. no.	TL	Ø	kg/100	PU	PE
150450	5	3	4,800	1	1
150452	10	3	9,900	1	1
150454	15	3	13,900	1	1
150456	20	3	16,300	1	1
150458	25	3	21,800	1	1
150462	5	4	8,000	1	1
150464	10	4	15,800	1	1
150466	15	4	24,000	1	1
150468	20	4	29,200	1	1
150470	25	4	38,900	1	1

Perlon fish tapes

made from stretched „Bayer-Perlon wire“, black, with solid steel end pieces, with 2 spring and 2 eyes, strip size 4 mm

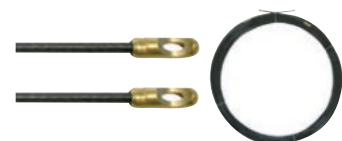

Art. no.	TL	Ø	kg/100	PU	PE
150476	10	4	18,000	1	1
150478	15	4	26,000	1	1
150480	20	4	33,200	1	1
150482	25	4	41,200	1	1

Fibreglas section fish rods kits

Fibre glass push rod set

in nylon bag.

Scope of delivery:

Push rod length: 7 m
5 rods 8 mm Ø black
2 rods 8 mm Ø white

Accessories:

1 hook, 1 chain, 1 magnet, 1 starting block, 1 pulling knob

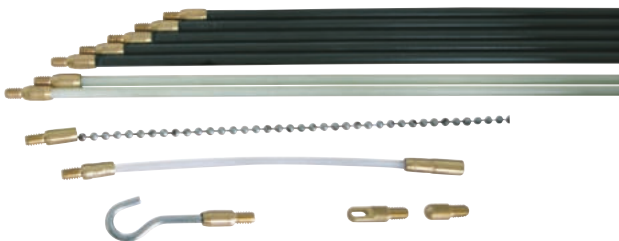

Art. no.	TL		kg	PU
150560	7	12 pcs.	0,500	1

Fibre glass push rod set

in nylon bag.

Scope of delivery:

Push rod length: 10 m
2 rods 6 mm Ø white
6 rods 5 mm Ø yellow
2 rods 4 mm Ø green

Accessories:

1 hook, 1 chain, 1 magnet, 1 starting block, 1 pulling knob, 1 LED lamp

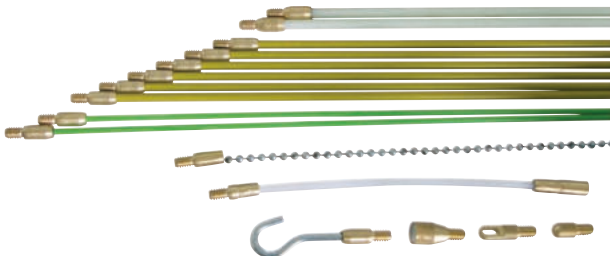

Art. no.	TL		kg	PU
150562 *	10	16 pcs.	0,700	1

HAUPA PullTec

Cable pulling device HAUPA PullTec

with special plastic coating, M5 thread and probe, in durable plastic housing, colour: black
„Single Composite“, 4 mm green

The advantages of the HAUPA PullTec at a glance:

- Material: Coated with a special plastic
- Slides very well and is highly elastic
- Low friction • Does not break or bend
- M5 thread • With probe
- In durable plastic housing • Breaking load: 300 kg



Art. no.	TL	Ø		kg	PU	
143500	20	M5	4	1,300	1	
143502 *	30	M5	4	1,500	1	
143501	20	M5	4	replacement rod	1,000	1
143503	30	M5	4	replacement rod	1,200	1
143508		M5	6	guiding head	0,200	1

Cable pulling device HAUPA PullTec

with special plastic coating, M5 thread and probe, in durable plastic housing, colour: black
„Single Composite“, 5,2 mm black

The advantages of the HAUPA PullTec at a glance:

- Material: Coated with a special plastic
- Slides very well and is highly elastic
- Low friction • Does not break or bend
- M5 thread • With probe
- In durable plastic housing • Breaking load: 350 kg



Art. no.	TL	Ø		kg	PU	
143506 *	30	M5	5,2	1,700	1	
143505	20	M5	5,2	replacement rod	1,100	1
143507	30	M5	5,2	replacement rod	1,300	1
143509		M5	6	guiding head	0,200	1

Additional accessories, see HAUPA fibre, page 92

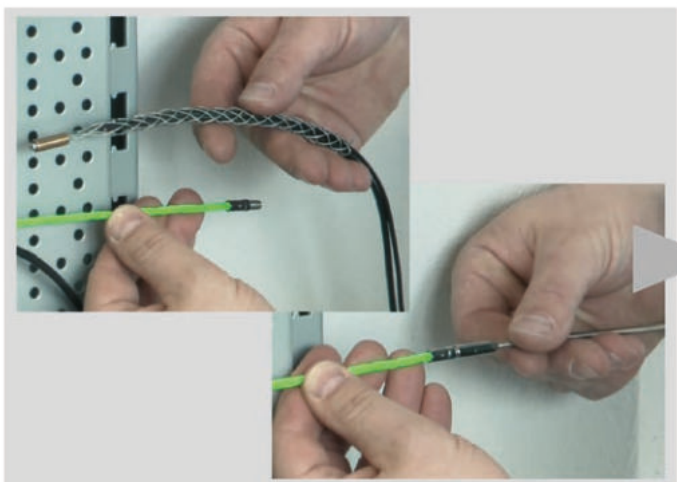

haupa®

... convincing solutions

Cable pulling device, accessories

Cable pulling device HAUPA-FIBRE

Cable pulling device with glass fibre rod \varnothing 3 mm, with PP casing, including front/end sleeve M5, 143010, 143024.

143000/143002 including:

- 143008 (2x)
- 143016 (2x)
- 143018 (2x)
- 143012
- 143014
- 143020
- 143026

143002/ECO including:

- 143008 (1x)



Art. no.	TL	\varnothing		kg	PU
143000	20	M5	3	HAUPA-FIBRE 20 m	1,199 1
143002	30	M5	3	HAUPA-FIBRE 30 m	1,500 1
143002/ECO	30	M5	3	HAUPA-FIBRE 30 m	1,198 1

Pulling unit with loop M5



Art. no.	\varnothing	kg	PU
143008	M5 6	0,020	1

Guiding head with loop M5



Art. no.	\varnothing	kg	PU
143010	M5 6	0,200	1

Guiding head M5



Art. no.	\varnothing	kg	PU
143012	M5 7	0,010	1

Guiding head M5



Art. no.	\varnothing	kg	PU
143014	M5 10	0,011	1

Guiding head \varnothing 13 mm M5



Art. no.	\varnothing	kg	PU
143030	M5 13	0,017	1

Front/end sleeve M5



Art. no.	kg	PU
143016	M5 0,005	1

Connection sleeve for probes \varnothing 3 mm

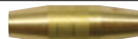

Art. no.	\varnothing	kg	PU
143018	M5 3	0,003	1

Cable grips



Art. no.	TL	\varnothing	kg	PU
143020	200	M5 4-6	0,007	1

Special pulling aid

for fast pulling of glass fibre rods \varnothing 3 mm



Art. no.	\varnothing	kg	PU
143024	3 - 6	0,047	1

Special fast glue for glass fibre rod \varnothing 3 mm



Art. no.	kg	PU
143026	0,012	1

Replacement glass fibre rod

\varnothing 3 mm, length 20/30 m, including front/end sleeve M5



Art. no.	TL	\varnothing	kg	PU
143004	20	3	0,022	1
143006	30	3	0,034	1

Service set for HAUPA-FIBRE

5 front sleeves, 5 guiding heads, 3 connection sleeves, 1 special fast glue



Art. no.	kg	PU
143028	M5 0,041	1

Cable pulling device, accessories

Cable pulling device FOX

Cable pulling device FOX with glass fibre rod \varnothing 4.5 mm and green PP coating RAL 6018, with zinc steel winder \varnothing 330 mm, standing version, complete with front/end sleeve M5 and pulling head M5 with loop



Art. no.	TL		\varnothing	kg	PU
143050	40	M5	4,5	3,900	1
143052	60	M5	4,5	4,400	1
143054	80	M5	4,5	4,800	1

Replacement glass fibre rod FOX

\varnothing 4.5 mm, complete with front/end sleeve M5



Art. no.	TL		\varnothing	kg	PU
143056	40	M5	4,5	0,900	1
143058	60	M5	4,5	1,400	1
143060	80	M5	4,5	1,800	1

Guiding head with loop M5



Art. no.		kg	PU
143062	M5	0,011	1

Front bulb with shackle M5



Art. no.		kg	PU
143064	M5	0,100	1

Guiding role made from aluminium M5



Art. no.		kg	PU
143066	M5	0,100	1

Guiding head M5



Art. no.		\varnothing	kg	PU
143012	M5	7	0,010	1
143014	M5	10	0,011	1
143030	M5	13	0,017	1

Guiding head set with heads \varnothing 7, 10, 13 mm M5



Art. no.			kg	PU
143068	M5	3-pieces	0,038	1

Front/end sleeve M5



Art. no.		kg	PU
143070	M5	0,100	1

Connection sleeve for probes \varnothing 4.5 mm



Art. no.	\varnothing	kg	PU
143072	4,5	0,002	1

haupa[®]

... convincing solutions

HAUPA GmbH & Co. KG, Koenigstr. 165-169, 42853 Remscheid, Phone: +49 (0)2191 8418-0, Fax: +49 (0)2191 8418-840, sales@haupa.com

Cable pulling device, accessories

Cable pulling device SIX

Cable pulling device SIX with glass fibre rod Ø 6.0 mm and green PP coating RAL 6018, with zinced steel winder Ø 550 mm, in lying and standing version with wheels, complete with front/end sleeve M6 and pulling head M6 with loop



lying version

Art. no.	TL	Ø	kg	PU
143100	40 M6	6	5,200	1
143102	60 M6	6	5,900	1
143104	80 M6	6	6,800	1
143105	100 M6	6	7,700	1

standing version

Art. no.	TL	Ø	kg	PU
143106	40 M6	6	7,200	1
143108	60 M6	6	8,300	1
143110	80 M6	6	9,400	1
143111	100 M6	6	10,300	1

standing version with wheels

Art. no.	TL	Ø	kg	PU
143112	40 M6	6	7,400	1
143114	60 M6	6	8,500	1
143116	80 M6	6	9,600	1
143117	100 M6	6	10,500	1

Replacement glass fibre rod SIX

Ø 6 mm, including front/end sleeve M5



Art. no.	TL	Ø	kg	PU
143118	40 M6	6	1,700	1
143120	60 M6	6	2,500	1
143122	80 M6	6	3,250	1
143124	100 M6	6	4,150	1

Guiding head with loop M6



Art. no.	Ø	kg	PU
143126	M6 6	0,018	1

Front bulb with shackle M6



Art. no.	Ø	kg	PU
143128	M6 6	0,022	1

Guiding role made from aluminium M6



Art. no.	Ø	kg	PU
143130	M6 6	0,026	1

Guiding head M6



Art. no.	Ø	kg	PU
143132	M6 6	0,017	1

Front/end sleeve M6



Art. no.	Ø	kg	PU
143134	M6 6	0,013	1

Connection shackle for probes Ø 6 mm



Art. no.	Ø	kg	PU
143136	6	0,012	1

Cable pulling device, accessories

Cable pulling device FIX

Cable pulling device FIX with glass fibre rod \varnothing 7.5 mm ad green PP coating RAL 6018, with zinced steel winder \varnothing 630 mm, in standing version and with wheels, including front/end sleeve M12 and front bulb with shackle M12



standing version

Art. no.	TL	\varnothing	kg	PU
143150	40 M12	7,5	8,100	1
143152	60 M12	7,5	9,400	1
143154	80 M12	7,5	10,700	1
143156	100 M12	7,5	11,900	1
143158	120 M12	7,5	13,100	1

standing version with wheels

Art. no.	TL	\varnothing	kg	PU
143160	40 M12	7,5	9,100	1
143162	60 M12	7,5	10,400	1
143164	80 M12	7,5	11,700	1
143166	100 M12	7,5	12,900	1
143168	120 M12	7,5	14,100	1

Replacement glass fibre rod FIX

\varnothing 7.5 mm, including front/end sleeve M12



Art. no.	TL	\varnothing	kg	PU
143170	40 M12	7,5	1,500	1
143172	60 M12	7,5	2,000	1
143174	80 M12	7,5	3,000	1
143176	100 M12	7,5	3,700	1
143178	120 M12	7,5	4,500	1

Front bulb with shackle M12



Art. no.	kg	PU
143180 M12	0,010	1

Guiding role made from aluminium M12



Art. no.	kg	PU
143182 M12	0,200	1

Guiding role made from aluminium, length 80 mm M12



Art. no.	\varnothing	kg	PU
143184 M12	40	0,220	1

Front/end sleeve M12



Art. no.	kg	PU
143186 M12	0,004	1

Connection sleeve for probes \varnothing 9 + 11 mm



Art. no.	\varnothing	kg	PU
143187 7,5	7,5	0,003	1

Connection sleeve with rotator



Art. no.	TL	\varnothing	kg	PU
143190	83 M12	30	0,006	1

Pipe cleaning brush



Art. no.	\varnothing	kg	PU
143200	80 mm	0,200	1
143202	97 mm	0,098	1
143204	117 mm	0,400	1

haupa[®]

... convincing solutions

HAUPA GmbH & Co. KG, Koenigstr. 165-169, 42853 Remscheid, Phone: +49 (0)2191 8418-0, Fax: +49 (0)2191 8418-840, sales@haupa.com

Cable pulling device, accessories

Cable pulling device STRONG

Cable pulling device STRONG with glass fibre rod \varnothing 9 mm and green PP coating RAL 6018, with zinc steel winder \varnothing 795 mm (1000 with wheels), in standing version and with wheels, including front/end sleeve M12 and front bulbs with shackle M12



standing version

Art. no.	TL	\varnothing	kg	PU
143210	40 M12	9	9,100	1
143212	60 M12	9	12,900	1
143214	80 M12	9	14,820	1

standing version with wheels

Art. no.	TL	\varnothing	kg	PU
143216	100 M12	9	29,400	1
143218	120 M12	9	31,300	1
143220	150 M12	9	33,900	1

Replacement glass fibre rod STRONG

\varnothing 9 mm, including front/end sleeve M12

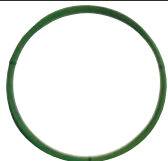

Art. no.	TL	\varnothing	kg	PU
143222	40 M12	9	3,800	1
143224	60 M12	9	5,500	1
143226	80 M12	9	7,500	1
143228	100 M12	9	9,400	1
143230	120 M12	9	11,300	1
143232	150 M12	9	13,900	1

Cable pulling device POWER

Cable pulling device POWER with glass fibre rod \varnothing 11 mm and green PP coating RAL 6018, with zinc steel winder \varnothing 1000 mm, width 150 mm, standing version with wheels, including front/end sleeve M12 and front bulb with shackle M12



standing version with wheels

Art. no.	TL	\varnothing	kg	PU
143250	150 M12	11	43,000	1
143252	200 M12	11	50,000	1
143254	250 M12	11	56,500	1
143256	300 M12	11	64,500	1

Replacement glass fibre rod POWER

\varnothing 11 mm, including front/end sleeve M12

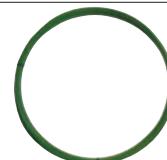

Art. no.	TL	\varnothing	kg	PU
143258	150 M12	11	21,900	1
143260	200 M12	11	29,200	1
143262	250 M12	11	36,400	1
143264	300 M12	11	43,900	1

Cable pulling device KING

Cable pulling device KING with glass fibre rod \varnothing 14.5 mm and black PP coating, with steel winder \varnothing 1500 mm with wheels, including front/end sleeve M12 and front bulb with shackle M12



standing version with wheels

Art. no.	TL	\varnothing	kg	PU
143270	150 M12	14,5	85,000	1
143272	200 M12	14,5	99,000	1
143274	250 M12	14,5	113,000	1
143276	300 M12	14,5	127,000	1
143278	350 M12	14,5	141,000	1
143280	400 M12	14,5	156,000	1

Cable pulling device, accessories

Front bulb with shackle M12



Art. no.			kg	PU
143180	M12		0,010	1

Guiding role made from aluminium M12



Art. no.			kg	PU
143182	M12		0,200	1

Guiding role made from aluminium, length 80 mm M12



Art. no.		Ø		kg	PU
143184	M12	40		0,220	1

Front/end sleeve M12



Art. no.		Ø		kg	PU
143185	M12	11		0,004	1

Connection sleeve for probes



Art. no.		Ø		kg	PU
143188		9		0,150	1
143266		11		0,075	1

Connection sleeve with rotator

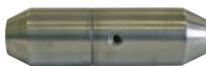

Art. no.	TL	Ø		kg	PU
143190	83 M12	30		0,006	1

Pipe cleaning brush



Art. no.		Ø		kg	PU
143200		80 mm		0,200	1
143202		97 mm		0,098	1
143204		117 mm		0,400	1

Accessories

Cable grips for electrical installations

Hand-braided cable grips made from zinc steel braid with a flexible Towing ring with front unit M5 and integrally moulded Talurit ferrule



Art. no.	TL	Ø	kg	PU
143300	200	M5 4-6	0,009	1
143302	210	M5 6-9	0,013	1
143304	350	M5 9-12	0,024	1
143306	350	M5 12-15	0,029	1
143308	500	M5 15-19	0,200	1
143310	500	M5 19-25	0,052	1
143312	450	M5 25-31	0,400	1

Cord und cable grips



Art. no.	TL	Ø	kg	PU
143336	2000	8-16	0,250	1
143338	2000	10-20	0,250	1
143340	2000	20-30	0,250	1
143342	2000	30-40	0,250	1

Cable grips for subterranean cable laying

Hand-braided cable grips made from zinc steel braid with 1 loop or 2 loops and integrally moulded Talurit ferrule.

Cable stocking with 2 loops enables, both the pulling of cables and the tightening of cables by way of relocating the stocking on the pulled cable.

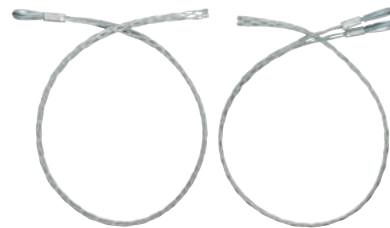

Art. no.	TL	Ø	Q	kg	PU
143314	1250	10-20	1	0,378	1
143318	1250	20-30	1	0,380	1
143322	1250	30-40	1	0,424	1
143326	1250	40-50	1	0,430	1
143330	1250	50-65	1	0,388	1
143334	1250	65-80	1	1,120	1
Art. no.	TL	Ø	Q	kg	PU
143316	1250	10-20	2	0,465	1
143320	1250	20-30	2	0,460	1
143324	1250	30-40	2	0,510	1
143328	1250	40-50	2	0,200	1
143332	1250	50-65	2	0,520	1

Legend cable pulling device

Rod diameter	Pipe diameter	Pushing energy	Min. bending radius	Breaking strength	Pulling strength with starting/ ending	Advised length	page
Ø mm	Ø mm	kg	mm	kg	kg	m	
FIBRE 3,0 mm	16-32	+++	160	400	110	20-30 (+ 2-3 m)	88
PullTec 4,0 mm	16-32	+++	100	300	130	10-30 (+ 3-5 m)	87
PullTec 5,2 mm	20-32	+++	100	350	140	10-40 (+ 3-5 m)	87
FOX 4,5 mm	40-60	+++	310	1200	170	20-40 (+ 3-5 m)	89
SIX 6,0 mm	50-80	++++	400	2000	230	30-60 (+ 3-5 m)	90
FIX 7,5 mm	63-100	++++	500	3200	290	40-70 (+ 3-5 m)	91
STRONG 9,0 mm	63-125	++++	620	4400	340	60-150 (+ 3-5 m)	92
POWER 11,0 mm	63-150	++++	770	6250	500	100-300 (+ 3-5 m)	92
KING 15,0 mm	100-250	++++	1150	15000	550	150-450 (+ 3-5 m)	92
PERLON® 3,0 mm	16	+	80	200	110	5-15 (+ 2-3 m)	86
SPIRAL 4,0 mm	20-32	+	180	115	115	10-25 (+ 3-5 m)	86

Decoiler



Decoiler

Decoiler 600

The new HAUPA decoiler have been designed for daily intensive use. The most important characteristics of this product are the ease of operation and the light weight. The side elements are made from galvanised powder-coated steel. The ball bearing drums can be adjusted without the need for specialist tools. Four vibration-damping feet prevent unwanted movement of the roller and protect the floor.

Technical data

Length: 350 mm
Width: 350 mm
Height: 105 mm



Art. no.	drum/width	drum-Ø	drum/kg	kg	PU
143398	330	600	50	3,5	1

Decoiler 1200

The new HAUPA cable decoilers are developed for intensive use. Ease of use and a low weight are fundamental characteristics of this product. The front and the rear sides are made of anodized aluminum with antiskid ribs. For the left and the right side, sink steel with powder coating has been used. Because of this construction, the decoilers are strong, flexible to use, and resistant against heavy circumstances. The roles have bearings and a sliding axis, which make it easy to change the position of the roles without any special tools. Four antiskid buffers ensure that vibrations are subdued and floors remain intact.

Technical data

Length: 610 mm
Width: 570 mm
Height: 115 mm



Art. no.	drum/width	drum-Ø	drum/kg	kg	PU
143400 *	560	1200	175	9	1

Decoiler 1200 +

The new HAUPA cable decoilers are developed for intensive use. Ease of use and a low weight are fundamental characteristics of this product. The front and the rear sides are made of anodized aluminum with antiskid ribs. For the left and the right side, sink steel with powder coating has been used. Because of this construction, the decoilers are strong, flexible to use, and resistant against heavy circumstances. The roles have bearings and a sliding axis, which make it easy to change the position of the roles without any special tools. Four antiskid buffers ensure that vibrations are subdued and floors remain intact.

Technical data

Length: 705 mm
Width: 670 mm
Height: 115 mm



Art. no.	drum/width	drum-Ø	drum/kg	kg	PU
143402	660	1200	300	10,5	1

Cable unwinder

Cable unwinder

4 box cable unwinder.

Carton size 240 x 240 mm



Art. no.	drum/width	drum-Ø	drum/kg	kg	PU
143406	600	130	50	5,5	1

Cable unwinder

Length: 400 mm

Width: 400 mm

Height: 390 mm



Video 143404



Art. no.	drum-Ø	drum/kg	kg	PU
143404	600	50	8	1

CableGo

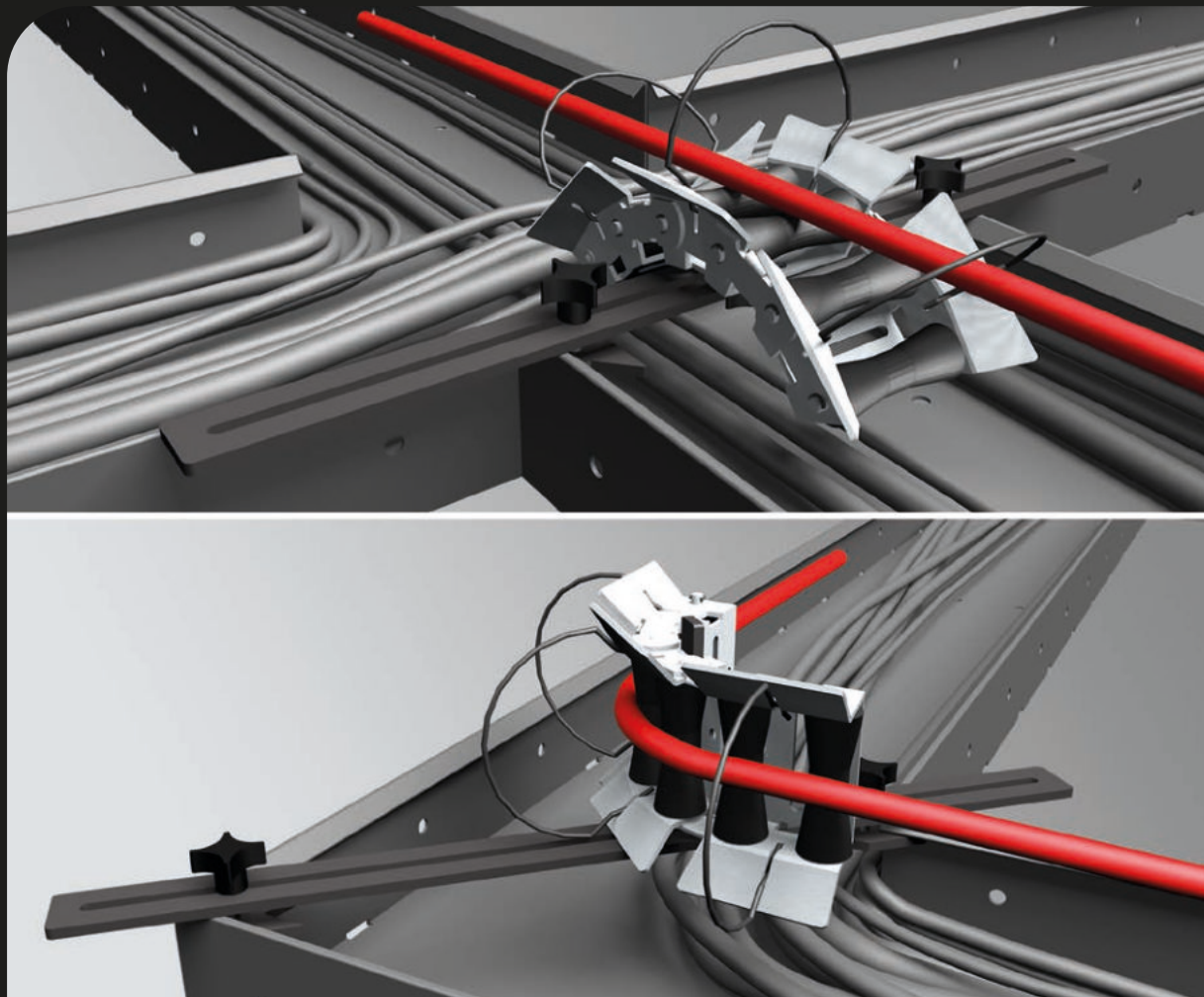

INFO

CableGo

An innovation in the cable pulling device technology

- suitable for all cable pulling devices
- quick and easy, with just one person
- reduced force expenditure
- no damage to cables, thus particularly suitable for cables in the field of data technology (for example, fiber optic cables)



CableGo

Cable pulling device „CableGo profi“



Content in plastik case:

- 3 x basic module „CableGo“ + 3 wire brackets
- 3 x table clamp „CableGo“
- 3 x mounting bracket „CableGo“
- 1 x connection set and several mounting parts „CableGo“

Video 143422



Art. no.		kg	PU
143422	14 pcs.	4,800	1

Cable pulling device „CableGo master“



Content in plastik case:

- 5 x basic module „CableGo“ + 3 wire brackets
- 5 x table clamp „CableGo“
- 5 x mounting bracket „CableGo“
- 1 x connection set and several mounting parts „CableGo“

Cable pulling device „CableGo starter“

Content in plastik case:

- 1 x basic module „CableGo“ + 3 wire brackets
- 1 x table clamp „CableGo“
- 1 x mounting bracket „CableGo“



Art. no.		kg	PU
143420	6 pcs.	9,000	1



Art. no.		kg	PU
143424	17 pcs.	6,800	1

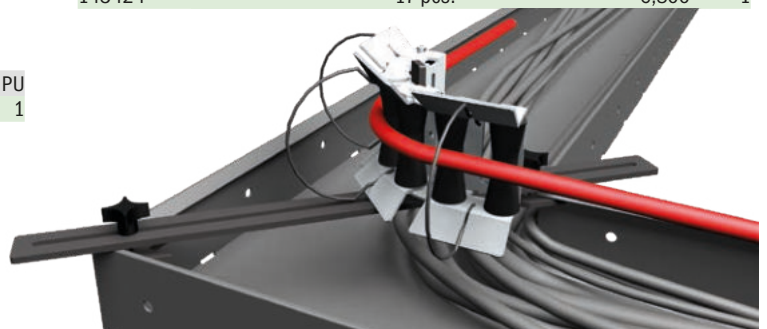

SysCon CableGo

SysCon cable pulling device „CableGo starter“

Content in SysCon stacking box art. 220372:

- 1 x basic module „CableGo“ + 3 wire brackets
- 1 x table clamp „CableGo“
- 1 x connection set and several mounting parts „CableGo“



Art. no.		kg	PU
143430	6 pcs.	3,700	1

SysCon cable pulling device „CableGo profi“



Content in SysCon stacking box art. 220372:

- 3 x basic module „CableGo“ + 3 wire brackets
- 3 x table clamp „CableGo“
- 3 x mounting bracket „CableGo“
- 1 x connection set and several mounting parts „CableGo“

Art. no.		kg	PU
143432	14 pcs.	5,700	1

SysCon cable pulling device „CableGo master“



Content in SysCon stacking box art. 220372:

- 5 x basic module „CableGo“ + 3 wire brackets
- 5 x table clamp „CableGo“
- 5 x mounting bracket „CableGo“
- 1 x connection set basic module „CableGo“

Art. no.		kg	PU
143434	17 pcs.	7,700	1

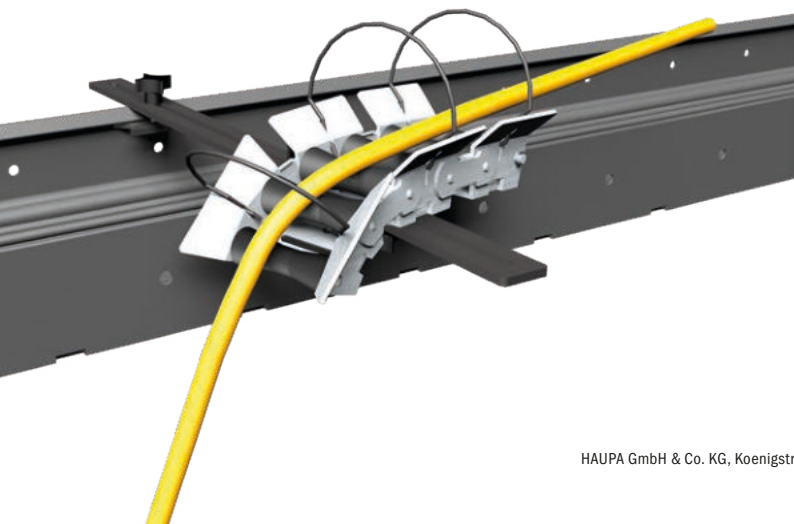

CableGo, accessories

Basic module „CableGo“ + 3 wire brackets

Basic module for easy cable penetrations in corners and roundings.

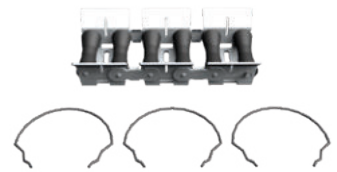

Art. no.		kg	PU
143440	4 pcs.	0,500	1

Table clamp „CableGo“

Table clamp for fixing basic modules.



Art. no.		kg	PU
143441	1 pcs.	0,080	1

Mounting bracket „CableGo“

Mounting bracket for fixing basic modules.



Art. no.		kg	PU
143442	7 pcs.	0,360	1

Connection set basic module „CableGo“

Connection set for connecting several basic modules.



Art. no.		kg	PU
143443	2 pcs.	0,025	1

Set 3 wire brackets „CableGo“

Wire brackets for basic modules.



Art. no.		kg	PU
143444	3 pcs.	0,045	1

haupa®

... convincing solutions

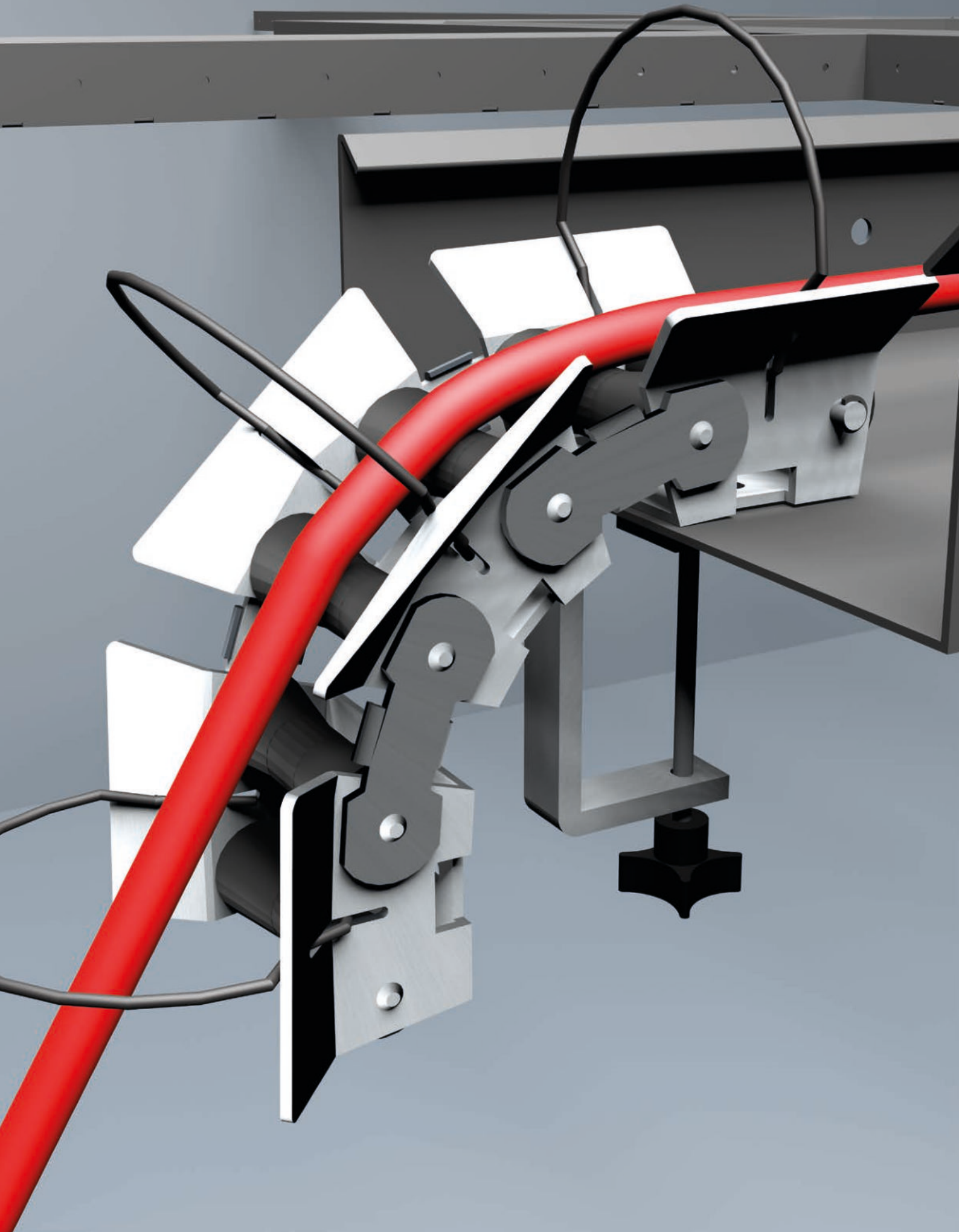

Connecting clamps



Connecting clamps

Connecting clamps PC

Transparent connecting clamps 2-8 pin, polycarbonate

PC



Art. no.	CSS	Pol	Volt	A	kg/100	PU
265013	1,0 - 2,5	2	450	24	0,013	100
265014	1,0 - 2,5	3	450	24	0,013	100
265015	1,0 - 2,5	4	450	24	0,013	100
265016	1,0 - 2,5	5	450	24	0,013	100
265017	1,0 - 2,5	8	450	24	0,013	100

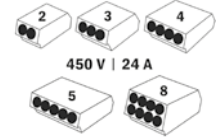

Connecting clamps, Nylon

Connecting clamps, 2-8 pin, Nylon

Nylon



Art. no.	CSS	Pol	Volt	A	kg/100	PU
265033	1,0 - 2,5	2	450	24	0,013	100
265034	1,0 - 2,5	3	450	24	0,013	100
265035	1,0 - 2,5	4	450	24	0,013	100
265036	1,0 - 2,5	5	450	24	0,013	100

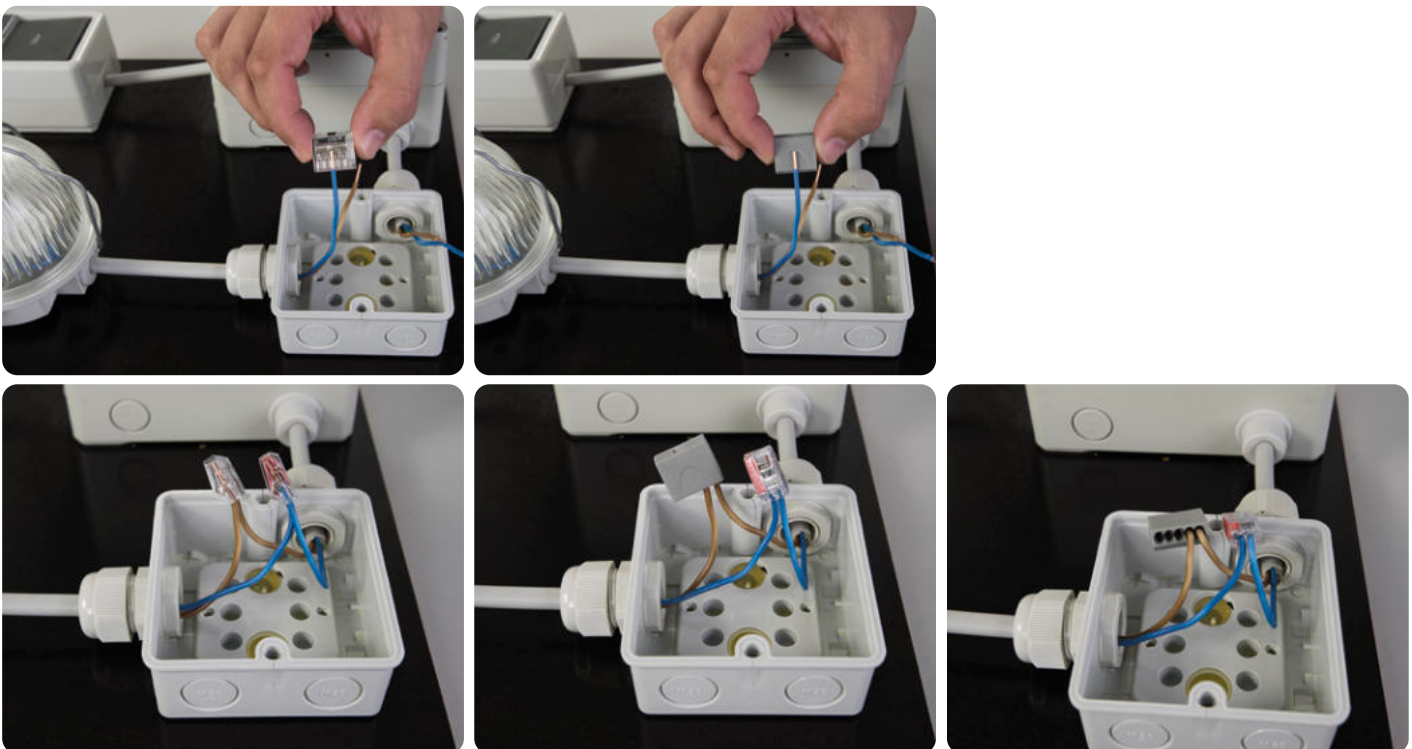
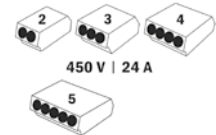

End sleeves



End sleeves

- of electrolytic copper, bare
- Dimensions to DIN 46228, Part 1

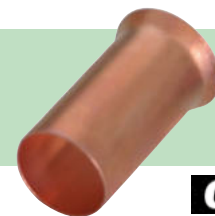

Cu

Art. no.	CSS	d1	d2	s	TL	kg/100	PU
270141	0,34	0,85	1,8	0,15	5	0,003	1000
270140	0,5	1,0	2,1	0,15	6	0,004	1000
270140/500		1,0	2,1	0,15	6	0,002	500
270142	0,75	1,2	2,3	0,15	6	0,005	1000
270142/500		1,2	2,3	0,15	6	0,003	500
270143		1,2	2,3	0,15	10	0,005	1000
270143/500		1,2	2,3	0,15	10	0,005	500
270144		1,2	2,3	0,15	12	0,007	1000
270146	1	1,4	2,5	0,15	6	0,005	1000
270146/500		1,4	2,5	0,15	6	0,004	500
270148		1,4	2,5	0,15	10	0,007	1000
270148/500		1,4	2,5	0,15	10	0,006	500
270149		1,4	2,5	0,15	12	0,009	1000
270149/500		1,4	2,5	0,15	12	0,009	500
270150	1,5	1,7	2,8	0,15	7	0,005	1000
270150/500		1,7	2,8	0,15	7	0,005	500
270152		1,7	2,8	0,15	10	0,009	1000
270152/500		1,7	2,8	0,15	10	0,008	500
270154		1,7	2,8	0,15	12	0,012	1000
270154/500		1,7	2,8	0,15	12	0,009	500
270156		1,7	2,8	0,15	18	0,014	1000
270156/500		1,7	2,8	0,15	18	0,014	500
270158	2,5	2,5	3,4	0,15	7	0,008	1000
270158/500		2,5	3,4	0,15	7	0,010	500
270159		2,5	3,4	0,15	10	0,013	1000
270159/500		2,5	3,4	0,15	10	0,013	500
270160		2,5	3,4	0,15	12	0,012	1000
270160/500		2,5	3,4	0,15	12	0,011	500
270164	4	2,8	4,0	0,2	9	0,018	1000
270164/500		2,8	4,0	0,2	9	0,014	500
270166		2,8	4,0	0,2	12	0,019	1000
270166/500		2,8	4,0	0,2	12	0,018	500
270168		2,8	4,0	0,2	18	0,030	1000
270168/500		2,8	4,0	0,2	18	0,030	500
270170	6	3,5	4,7	0,2	10	0,020	250
270172		3,5	4,7	0,2	12	0,022	250
270174		3,5	4,7	0,2	15	0,034	250
270176		3,5	4,7	0,2	18	0,034	250
270178	10	4,5	5,8	0,2	12	0,028	250
270180		4,5	5,8	0,2	15	0,054	250
270182		4,5	5,8	0,2	18	0,068	250
270184	16	5,8	7,5	0,2	12	0,045	250
270186		5,8	7,5	0,2	15	0,057	250
270188		5,8	7,5	0,2	18	0,059	250
270190	25	7,3	9,5	0,2	12	0,058	250
270192		7,3	9,5	0,2	18	0,080	250
270194	35	8,3	11,0	0,2	18	0,114	100
270195		8,3	11,0	0,2	20	0,108	100
270196		8,3	11,0	0,2	22	0,100	100
270198		8,3	11,0	0,2	26	0,110	100

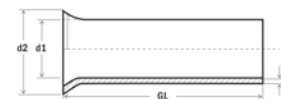

End sleeves

End sleeves

- of electrolytic copper, tin-plated
- Dimensions to DIN 46228, Part 1



Cu

Art. no.	CSS	d1	d2	s	TL	kg/100	PU
270066	0,25	0,75	1,7	0,15	5	0,003	1000
270066/500		0,75	1,7	0,15	5	0,002	500
270068	0,34	0,85	1,8	0,15	5	0,003	1000
270068/500		0,85	1,8	0,15	5	0,001	500
270070	0,5	1,0	2,1	0,15	6	0,003	1000
270070/500		1,0	2,1	0,15	6	0,003	500
270072	0,75	1,2	2,3	0,15	6	0,003	1000
270072/500		1,2	2,3	0,15	6	0,003	500
270074		1,2	2,3	0,15	12	0,007	1000
270074/500		1,2	2,3	0,15	12	0,003	500
270076	1	1,4	2,5	0,15	6	0,004	1000
270077		1,4	4,0	0,15	8	0,005	1000
270078		1,4	2,5	0,15	10	0,007	1000
270078/500		1,4	2,5	0,15	10	0,003	500
270079		1,4	2,5	0,15	12	0,008	1000
270079/500		1,4	2,5	0,15	12	0,004	500
270080	1,5	1,7	2,8	0,15	7	0,006	1000
270082		1,7	2,8	0,15	10	0,009	1000
270082/500		1,7	2,8	0,15	10	0,005	500
270084		1,7	2,8	0,15	12	0,010	1000
270084/500		1,7	2,8	0,15	12	0,005	500
270086		1,7	2,8	0,15	18	0,010	1000
270086/500		1,7	2,8	0,15	18	0,010	500
270087		1,7	2,8	0,15	20	0,018	1000
270088	2,5	2,2	3,4	0,15	7	0,008	1000
270089		2,2	3,4	0,15	10	0,017	1000
270089/500		2,2	3,4	0,15	10	0,017	500
270090		2,2	3,4	0,15	12	0,011	1000
270090/500		2,2	3,4	0,15	12	0,011	500
270091		2,2	3,4	0,15	15	0,015	1000
270091/500		2,2	3,4	0,15	15	0,015	500
270092		2,2	3,4	0,15	18	0,023	1000
270092/500		2,2	3,4	0,15	18	0,023	500
270093		2,2	3,4	0,15	20	0,020	1000
270093/500		2,2	3,4	0,15	20	0,020	500
270094	4	2,8	4,0	0,2	9	0,015	1000
270096		2,8	4,0	0,2	12	0,020	1000
270097		2,8	4,0	0,2	15	0,024	1000
270098		2,8	4,0	0,2	18	0,030	1000
270100	6	3,5	4,7	0,2	10	0,020	250
270102		3,5	4,7	0,2	12	0,024	250
270104		3,5	4,7	0,2	15	0,031	250
270106		3,5	4,7	0,2	18	0,036	250
270107		3,5	4,7	0,2	20	0,040	250
270108	10	4,5	5,8	0,0	12	0,032	250
270110		4,5	5,8	0,2	15	0,039	250
270112		4,5	5,8	0,2	18	0,045	250
270114	16	5,8	7,5	0,2	12	0,044	250
270116		5,8	7,5	0,2	15	0,056	250
270118		5,8	7,5	0,2	18	0,068	250
270119		5,8	7,5	0,2	24	0,104	250
270120	25	7,3	9,5	0,2	12	0,063	250
270121		7,3	9,5	0,2	15	0,075	250
270122		7,3	9,5	0,2	18	0,085	250
270123		7,3	9,5	0,2	25	0,121	100
270124	35	8,3	11,0	0,2	18	0,112	100
270126		8,3	11,0	0,2	22	0,132	100
270128		8,3	11,0	0,2	25	0,143	100
270130		8,3	11,0	0,2	30	0,155	100
270131	50	10,3	13,0	0,3	22	0,202	100
270132	70	12,5	15,0	0,4	25	0,259	100
270134	95	14,5	17,0	0,4	30	0,500	50
270135	120	16,5	19,0	0,5	32	0,660	50
270136	150	18,5	21,0	0,5	38	0,529	50
270137	185	20,0	23,5	0,6	40	1,350	25

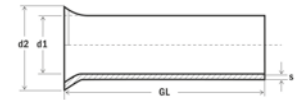

End sleeves DIN colour range

- insulated
- Electrolytic copper, tin-plated
- Dimensions to DIN 46228. Part 4
- DIN colour range III

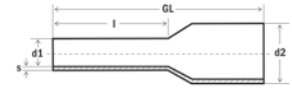

Art. no.	CSS		d1	d2	s	TL	I	kg/100	PU
270800 *	0,5	white	1,1	3,1	0,15	14,0	8	0,010	100
270801		white	1,1	3,1	0,15	14,0	8	0,009	500
270802 *	0,75	grey	1,25	3,3	0,15	14,0	8	0,009	500
270803		grey	1,25	3,3	0,15	14,0	8	0,013	100
272803		grey	1,2	2,8	0,15	16,0	10	0,012	100
270804	1	red	1,5	3,5	0,15	14,6	8	0,014	100
270805		red	1,5	3,5	0,15	14,6	8	0,009	500
272804		red	1,4	3,0	0,15	16,0	10	0,013	100
270806		red	1,5	3,5	0,15	18,0	12	0,013	500
270807 *	1,5	black	1,7	4,0	0,15	14,6	8	0,013	500
270808		black	1,7	4,0	0,15	14,6	8	0,014	100
270809		black	1,7	4,0	0,15	14,6	10	0,111	100
270810	2,5	blue	2,3	4,9	0,15	15,0	8	0,020	100
270811		blue	2,3	4,9	0,15	15,0	8	0,017	500
270812		blue	2,3	4,9	0,15	16,5	10	0,018	500
272812		blue	2,2	4,2	0,15	17,4	10	0,030	100
270813		blue	2,3	4,9	0,15	25,0	18	0,030	500
270814 *	4	grey	2,9	5,6	0,2	17,7	10	0,030	100
270815		grey	2,9	5,6	0,2	17,7	10	0,030	500
270816		grey	2,9	5,6	0,2	25,7	18	0,040	100
270818 *	6	yellow	3,6	7,0	0,2	20,0	12	0,045	100
270820		yellow	3,6	7,0	0,2	26,0	18	0,055	100
270822 *	10	red	4,6	8,4	0,2	21,5	12	0,057	100
270824		red	4,6	8,4	0,2	27,5	18	0,072	100
270826 *	16	blue	6,0	9,6	0,2	22,2	12	0,082	100
270828		blue	6,0	9,6	0,2	28,2	18	0,103	100
270830 *	25	yellow	7,3	12,0	0,2	30,0	16	0,142	50
270832		yellow	7,3	12,0	0,2	32,0	18	0,152	50
270834		yellow	7,3	12,0	0,2	36,0	22	0,168	50
270836 *	35	red	8,3	13,5	0,2	30,0	16	0,168	50
270838		red	8,3	13,5	0,2	32,0	18	0,178	50
270840		red	8,3	13,5	0,2	39,0	25	0,218	50
270842 *	50	blue	10,3	15,0	0,3	36,0	20	0,344	50
270844		blue	10,3	15,0	0,3	40,0	25	0,404	50
270762	70	yellow	13,5	17,2	0,4	37,0	21	0,540	25
270859	95	red	14,8	15,6	0,4	44,0	25	0,600	25
270861	120	blue	16,7	17,7	0,5	47,6	27	0,780	25
270863	150	yellow	19,6	20,6	0,5	57,6	32	0,123	25

End sleeves

End sleeves in tape form, to DIN 46228 P. 4

- insulated
- Copper/plastic, tin-plated surface
- DIN color range III

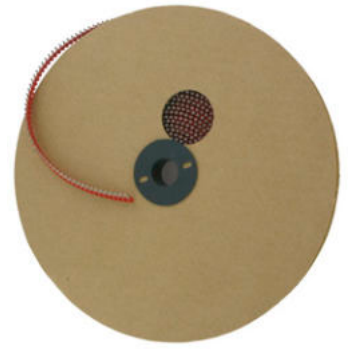

Art. no.	CSS		l	coils	kg/100	PU
272250	0,5	white	8	Ø 250 mm	0,010	3000
272254	0,75	grey	8	Ø 250 mm	0,030	3000
272260	1,0	red	8	Ø 250 mm	0,010	3000
272264	1,5	black	8	Ø 250 mm	0,010	2500
272268	2,5	blue	8	Ø 250 mm	0,010	1500

End sleeves in tape form, to DIN 46228 P. 4

- insulated
- Copper/plastic, tin-plated surface



Art. no.	CSS		l	dispenser	kg/100	PU
272280	0,5	white	8	150x150x18 mm	0,070	1000
272284	0,75	grey	8	150x150x18 mm	0,100	1000
272290	1	red	8	150x150x18 mm	0,120	1000
272294	1,5	black	8	150x150x18 mm	0,120	1000
272298	2,5	blue	8	150x150x18 mm	0,140	500

End sleeves

End sleeves, colour range I, (french)

- insulated
- Electrolytic copper, tin-plated
- Dimensions to DIN 46228. Part 4
- Colour range I, french



Art. no.	CSS		d1	d2	s	TL	l	kg/100	PU
270014	0,25	yellow	0,8	2,3	0,15	10,4	6	0,005	100
270015		yellow	0,8	2,3	0,15	10,4	6	0,023	500
270016	0,34	green	0,8	2,5	0,15	12,4	6	0,022	500
270800	0,5	white	1,1	3,1	0,15	14,0	8	0,010	100
270801		white	1,1	3,1	0,15	14,0	8	0,009	500
270021	0,75	blue	1,25	3,3	0,15	14,5	8	0,021	100
270022		blue	1,25	3,3	0,15	14,5	8	0,021	500
270804	1	red	1,5	3,5	0,15	14,6	8	0,014	100
270805		red	1,5	3,5	0,15	14,6	8	0,009	500
270808	1,5	black	1,7	4,0	0,15	14,6	8	0,014	100
270027		black	1,7	4,0	0,15	24,4	18	0,022	100
270028		black	1,7	4,0	0,15	24,4	18	0,022	500
270029	2,5	grey	2,3	4,9	0,15	15,0	8	0,020	100
270030		grey	2,3	4,9	0,15	15,0	8	0,020	500
270031		grey	2,3	4,9	0,15	21,0	18	0,028	100
270032		grey	2,3	4,9	0,15	21,0	18	0,028	500
270033	4	orange	2,9	5,6	0,2	17,7	10	0,029	100
270034		orange	2,9	5,6	0,2	17,7	10	0,029	500
270036		orange	2,9	5,6	0,2	25,7	18	0,040	100
270038	6	green	3,6	7,0	0,2	20,0	12	0,043	100
270040		green	3,6	7,0	0,2	26,0	18	0,065	100
270042	10	brown	4,6	8,4	0,2	21,5	12	0,046	100
270044		brown	4,6	8,4	0,2	27,5	18	0,073	100
270046	16	ivory	6,0	9,6	0,2	24,2	12	0,081	100
270048		ivory	6,0	9,6	0,2	28,2	18	0,103	100
270049	25	black	7,3	12,0	0,2	30,0	16	0,070	50
270050		black	7,3	12,0	0,2	32,0	18	0,079	50

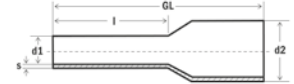

End sleeves, colour range II, (german)

- insulated
- Electrolytic copper, tin-plated
- Colour range II, german

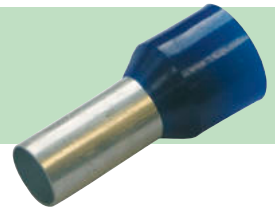

Art. no.	CSS		d1	d2	s	TL	l	kg/100	PU
270714	0,25	light blue	0,8	2,3	0,15	10,4	6	0,007	100
270715		light blue	0,8	2,3	0,15	10,4	6	0,005	500
270716	0,34	emerald	0,8	2,5	0,15	10,4	6	0,005	500
270719	0,5	orange	1,1	3,1	0,15	14,0	8	0,010	100
270720		orange	1,1	3,1	0,15	14,0	8	0,009	500
270721	0,75	white	1,25	3,3	0,15	14,6	8	0,012	100
270722		white	1,25	3,3	0,15	14,6	8	0,011	500
272721		white	1,2	2,8	0,15	16,0	10	0,012	100
270723	1	yellow	1,5	3,5	0,15	14,6	8	0,013	100
270724		yellow	1,5	3,5	0,15	14,6	8	0,011	500
272723		yellow	1,4	3,0	0,15	16,0	10	0,013	100
270725	1,5	red	1,7	4,0	0,15	14,6	8	0,015	100
270726		red	1,7	4,0	0,15	14,6	8	0,013	500
272725		red	1,7	3,5	0,15	16,0	10	0,015	100
270727		red	1,7	4,0	0,15	24,4	18	0,023	100
270728		red	1,7	4,0	0,15	24,4	18	0,023	500
270810	2,5	blue	2,3	4,9	0,15	15,0	8	0,020	100
270811		blue	2,3	4,9	0,15	15,0	8	0,017	500
270812		blau	2,3	4,9	0,15	16,5	8	0,018	500
272812		blau	2,3	4,9	0,15	17,4	10	0,030	500
270813		blue	2,3	4,9	0,15	25,0	18	0,030	500
270814	4	grey	2,9	5,6	0,2	17,7	10	0,030	100
270815		grey	2,9	5,6	0,2	17,7	10	0,030	500
270816		grey	2,9	5,6	0,2	25,7	18	0,040	100
270738	6	black	3,6	7,0	0,2	20,0	12	0,050	100
270740		black	3,6	7,0	0,2	26,0	18	0,062	100
270742	10	ivory	4,6	8,4	0,2	21,5	12	0,066	100
270744		ivory	4,6	8,4	0,2	27,5	18	0,081	100
270746	16	green	6,0	9,6	0,2	22,2	12	0,080	100
270748		green	6,0	9,6	0,2	28,2	18	0,104	100
270750	25	brown	7,3	11,2	0,2	29,0	16	0,132	50
270754	35	beige	8,3	12,7	0,2	30,0	16	0,170	50
270756		beige	8,3	12,7	0,2	39,0	25	0,400	25
270758	50	olive	10,3	15,0	0,3	36,4	20	0,328	25
270760		olive	10,3	15,0	0,3	41,0	25	0,300	25
270762	70	yellow	13,5	17,2	0,4	37,0	21	0,536	25

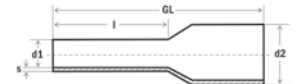

End sleeves

End sleeves for short-circuit-proof cables

- for short-circuit-proof cables with extra thick insulation (NSFGAFÖU)

Application: Infeed or branches in front of mains switch, in switching stations, distributors or with rail vehicles, solar heating units, ignition cables



Art. no.	CSS		d1	d2	l	kg/100	PU
270900	1,5	black	1,8	6,8	8	0,026	100
270902		black	1,8	6,8	10	0,024	100
270904	2,5	blue	2,3	7,8	8	0,033	100
270906		blue	2,3	7,8	12	0,360	100
270908	4	grey	2,9	7,8	10	0,046	100
270910	6	yellow	3,8	7,3	12	0,062	100
270912	10	red	4,5	9,8	12	0,081	100
270914	16	blue	6,0	12,2	12	0,107	100

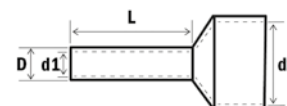

Twin-end sleeves two cables DIN

- tube section of electrolytic copper
- galvanically tin-plated
- plastic collar of PP
- heat-resistant to 105°C

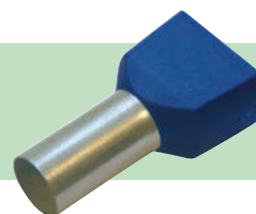

Art. no.	CSS		d1	s	TL	l	kg/100	PU
270778 *	0,5	white	1,5	0,15	15,0	8	0,011	100
270780 *	0,75	grey	1,8	0,15	15,0	8	0,013	100
270782		grey	1,8	0,15	17,0	10	0,014	100
270784 *	1	red	2,05	0,15	15,0	8	0,014	100
270787		red	2,05	0,15	17,0	10	0,015	100
270788 *	1,5	black	2,3	0,15	16,0	8	0,017	100
270790		black	2,3	0,15	20,0	12	0,022	100
270792 *	2,5	blue	2,9	0,2	18,5	10	0,029	100
270794 *		blue	2,9	0,2	21,5	13	0,033	100
270796 *	4	grey	3,8	0,2	23,0	12	0,049	100
270797 *	6	yellow	4,9	0,2	25,0	14	0,072	100
270798 *	10	red	6,5	0,2	26,0	14	0,090	100
270799 *	16	blue	8,3	0,2	31,0	16	0,078	50

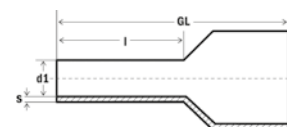

End sleeves

Twin-end sleeves, colour series II (German)

- insulated
- Copper/plastic, tin-plated surface
- Colour range II, german

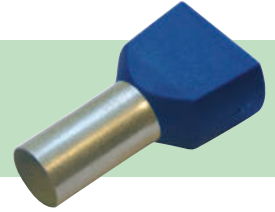

Art. no.	CSS	d1	s	TL	l	kg/100	PU
273350	0,5 orange	1,5	0,15	15,0	8	0,031	100
273352	0,75 white	1,8	0,15	15,0	8	0,031	100
273354	white	1,8	0,15	17,0	10	0,031	100
273356	1 yellow	2,05	0,15	15,0	8	0,031	100
273358	yellow	1,7	0,15	17,0	12	0,031	100
273360	1,5 red	2,3	0,15	16,0	8	0,031	100
273362	red	2,3	0,15	20,0	12	0,031	100
273392	2,5 blue	2,9	0,2	18,5	10	0,029	100
273394	blue	2,9	0,2	21,5	13	0,029	100
273396	4 grey	3,8	0,2	23,0	12	0,049	100
273364	6 black	4,9	0,2	25,0	14	0,031	100
273366	10 ivory	6,5	0,2	26,0	14	0,031	100
273368	16 green	8,3	0,2	31,0	16	0,031	50

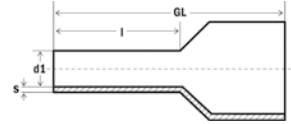

End sleeves colour range III, DIN "SmallPack"

- insulated
- Electrolytic copper, tin-plated
- Dimensions to DIN 46228. Part 4
- DIN colour range III

Art. no.	CS	d1	d2	s	TL	l	kg/100	PU
270800/25	0,5 white	1,1	3,1	0,15	14,0	8	0,010	250
270803/25	0,75 grey	1,25	3,3	0,15	14,0	8	0,013	250
270804/25	1 red	1,5	3,5	0,15	14,6	8	0,014	250
270808/25	1,5 black	1,7	4,0	0,15	14,6	8	0,014	250
270810/25	2,5 blue	2,3	4,9	0,15	15,0	8	0,020	250
270814/25	4 grey	2,9	5,6	0,2	17,7	10	0,030	250
270818/10	6 yellow	3,6	7,0	0,2	20,0	12	0,045	100
270822/10	10 red	4,6	8,4	0,2	21,5	12	0,057	100
270826/10	16 blue	6,0	9,6	0,2	22,2	12	0,082	100
270830/5	25 yellow	7,3	12,0	0,2	30,0	16	0,142	50
270836/5	35 red	8,3	13,5	0,2	30,0	16	0,168	50



Twin-end sleeves two cables DIN "SmallPack"

- tube section of electrolytic copper
- galvanically tin-plated
- plastic collar of PP
- heat-resistant to 105°C

Art. no.	LCSQ	d1	s	TL	l	kg/100	PU
270778/25	0,5 white	1,5	0,15	15,0	8	0,011	250
270780/25	0,75 grey	1,8	0,15	15,0	8	0,013	250
270784/25	1 red	2,05	0,15	15,0	8	0,014	250
270788/25	1,5 black	2,3	0,15	16,0	8	0,017	250
270792/25	2,5 blue	2,9	0,2	18,5	10	0,029	250
270796/10	4 grey	3,8	0,2	23,0	12	0,049	100
270797/10	6 yellow	4,9	0,2	25,0	14	0,072	100
270798/5	10 red	6,5	0,2	26,0	14	0,090	100
270799/5	16 blue	8,3	0,2	31,0	16	0,078	50



Empty dispenser box



Art. no.	kg	PU
270870	0,049	5

Dispenser box with uninsulated end sleeves

Contents: tin-plated end sleeves
 700 pcs. 0.5 mm², art. 270070
 1000 pcs. 0.75 mm², art. 270072
 800 pcs. 1.0 mm², art. 270076
 500 pcs. 1.5 mm², art. 270080
 450 pcs. 2.5 mm², art. 270088



Art. no.	kg	PU
270217	0,240	1

Dispenser box with uninsulated end sleeves

Contents: tin-plated end sleeves
 200 pcs. 4 mm², art. 270094
 100 pcs. 6.0 mm², art. 270102
 50 pcs. 10.0 mm², art. 270108
 50 pcs. 16.0 mm², art. 270114



Art. no.	kg	PU
270218	0,158	1

Dispenser box with insulated end sleeves (DIN)

Contents: Colour range III, DIN
 50 pcs. white, 0.5 mm², art. 270800
 100 pcs. grey, 0.75 mm², art. 270802
 100 pcs. red, 1.0 mm², art. 270804
 100 pcs. black, 1.5 mm², art. 270807
 50 pcs. blue, 2.5 mm², art. 270810



Art. no.	kg	PU
270854 *	0,090	1

Dispenser box with insulated end sleeves (DIN)

Contents: Colour range III, DIN
 50 pcs. grey, 4 mm², art. 270815
 20 pcs. yellow, 6 mm², art. 270818
 20 pcs. red, 10 mm², art. 270822
 10 pcs. blue, 16 mm², art. 270826



Art. no.	kg	PU
270858	0,089	1

Dispenser box with Twin end sleeves (DIN)

Contents:
 50 pcs. grey, 0.75 mm², art. 270780
 50 pcs. red, 1.0 mm², art. 270784
 50 pcs. black, 1.5 mm², art. 270788
 50 pcs. blue, 2.5 mm², art. 270792



Art. no.	kg	PU
270795 *	0,080	1

Dispenser box with insulated end sleeves (german)

Contents: Colour range II
 50 pcs. orange, 0.5 mm², art. 270719
 100 pcs. white, 0.75 mm², art. 270721
 100 pcs. yellow, 1.0 mm², art. 270723
 100 pcs. red, 1.5 mm², art. 270725
 50 pcs. blue, 2.5 mm², art. 270810



Art. no.	kg	PU
270852	0,089	1

Dispenser box with insulated end sleeves (german)

Contents: Colour range II
 50 pcs. grey, 4 mm², art. 270814
 20 pcs. black, 6 mm², art. 270738
 20 pcs. ivory, 10 mm², art. 270742
 10 pcs. green, 16 mm², art. 270746



Art. no.	kg	PU
270856	0,087	1

Dispenser box with insulated end sleeves (french)

Contents: Colour range I
 50 pcs. white, 0.5 mm², art. 270800
 100 pcs. blue, 0.75 mm², art. 270021
 100 pcs. red, 1.0 mm², art. 270804
 100 pcs. black, 1.5 mm², art. 270808
 50 pcs. grey, 2.5 mm², art. 270029



Art. no.	kg	PU
270850	0,090	1

Slide Box with DIN end sleeves

The transparent sliding lids enable easy access and prevent the contents from becoming mixed up.

Product features:

Handy plastic box with Euro holes, 5 separate compartments, simple access through sliding lids, no mixing of contents.
Dimensions: 165 x 58 x 38 mm (L x W x H)

Content: Colour range III DIN

- 50 pcs white, 0.5 mm², art. 270800
- 100 pcs. grey, 0.75 mm², art. 270802
- 100 pcs. red, 1.0 mm², art. 270804
- 100 pcs. black, 1.5 mm², art. 270807
- 50 pcs. blue, 2.5 mm², art. 270810



Art. no.	kg	PU
270864	0,109	1

Slide Box with DIN TWIN end sleeves

Content:

- 50 pcs. white, 2 x 0,5 mm², art. 270778
- 50 pcs. grey, 2 x 0,75 mm², art. 270780
- 50 pcs. red, 2 x 1,0 mm², art. 270784
- 50 pcs. black, 2 x 1,5 mm², art. 270788
- 25 pcs. blue, 2 x 2,5 mm², art. 270792



Art. no.	kg	PU
270866	0,104	1

Assortments of wire-end sleeves

- Content:** 5.000 insulated wire-end sleeves, 1 crimping pliers (21 08 04), crimping range 0,08 - 10 mm² in plastic bulk storage chest 415 x 335 x 90 mm.
- 100 Twin end sleeves 8/0,5, white, art. 270778
 - 100 Twin end sleeves 8/0,75, grey, art. 270780
 - 100 Twin end sleeves 8/1, red, art. 270784
 - 100 Twin end sleeves 8/1,5, black, art. 270788
 - 100 Twin end sleeves 10/2,5, blue, art. 270792
 - 100 Twin end sleeves 12/4,0, grey, art. 270796
 - 100 Twin end sleeves 14/6,0, yellow, art. 270797
 - 500 insulated end sleeves 8/0,5, white, art. 270801
 - 500 insulated end sleeves 8/0,75, grey, art. 270802
 - 1.000 insulated end sleeves 8/1, red, art. 270805
 - 1.000 insulated end sleeves 8/1,5, black, art. 270807
 - 500 insulated end sleeves 8/2,5, blue, art. 270811
 - 500 insulated end sleeves 10/4, grey, art. 270815
 - 200 insulated end sleeves 12/6, yellow, art. 270818
 - 200 insulated end sleeves 12/10, red, art. 270822



Art. no.	Content	type	kg	PU
270888	5000	DIN	2,150	1
270890	5000	II	2,150	1

Assortments of wire-end sleeves

- Content:** 5.300 insulated wire-end sleeves, 1 crimping pliers (21 08 42), crimping range 1 - 10 mm², in plastic bulk storage chest 415 x 335 x 90 mm.
- 1.000 insulated end sleeves 8/1, red, art. 270805
 - 1.000 insulated end sleeves 8/1,5, black, art. 270807
 - 1.000 insulated end sleeves 8/2,5, blue, art. 270811
 - 500 insulated end sleeves 10/4, grey, art. 270815
 - 200 insulated end sleeves 12/6, yellow, art. 270818
 - 200 insulated end sleeves 12/10, red, art. 270822
 - 500 insulated end sleeves 12/1, red, art. 270806
 - 300 insulated end sleeves 18/1,5, black, art. 270027
 - 250 insulated end sleeves 18/2,5, blue, art. 270813
 - 200 insulated end sleeves 18/4, grey, art. 270816
 - 100 insulated end sleeves 18/6, yellow, art. 270820
 - 50 insulated end sleeves 18/10, red, art. 270824



Art. no.	Content	type	kg	PU
270891	5300	DIN	2,100	1
270892	5300	I	2,100	1
270893	5300	II	2,100	1

End sleeve assortment – serie DIN

Content: 1.150 insulated end sleeves crimping pliers (art. no. 210824), crimp 0,75 - 16,0 mm², in plastic bulk storage chest 415 x 335 x 90 mm.
 200 insulated end sleeves 8/0,75, grey, art. 270803
 200 insulated end sleeves 8/1, red, art. 270804
 200 insulated end sleeves 8/1,5, black, art. 270808
 200 insulated end sleeves 8/2,5, blue, art. 270810
 100 insulated end sleeves 10/4, grey, art. 270814
 100 insulated end sleeves 12/6, yellow, art. 270818
 100 insulated end sleeves 18/10, red, art. 270824
 50 insulated end sleeves 18/16, blue, art. 270828



Art. no.	Content	type	kg	PU
270882/DIN	1150	DIN	1,740	1
270882	1150	I	1,700	1
270894	1150	II	2,150	1

End sleeve assortment – serie DIN

Content: 4.700 insulated end sleeves, in plastic bulk storage chest 415 x 335 x 90 mm.
 100 Twin end sleeves 8/0,5, white, art. 270778
 100 Twin end sleeves 8/0,75, grey, art. 270780
 100 Twin end sleeves 8/1, red, art. 270784
 100 Twin end sleeves 8/1,5, black, art. 270788
 100 Twin end sleeves 10/2,5, blue, art. 270792
 100 Twin end sleeves 12/4, grey, art. 270796
 100 Twin end sleeves 14/6, yellow, art. 270797
 100 Twin end sleeves 14/10, red, art. 270798
 500 insulated end sleeves 8/0,5, white, art. 270801
 500 insulated end sleeves 8/0,75, grey, art. 270802
 500 insulated end sleeves 8/1, red, art. 270805
 1000 insulated end sleeves 8/1,5, black, art. 270807
 500 insul. end sleeves 8/2,5, blue, art. 270811
 500 insulated end sleeves 10/4, grey, art. 270815
 200 insul. end sl. 10/6, yellow, art. 270818
 200 insul. end sl. 12/10, red, art. 270822



Art. no.	Content	kg	PU
270899	4700	2,150	1

Assortment for Combi-Crimp – DIN

Content: 1 crimping pliers (210784) for insulated terminals 0,5 - 2,5 mm² and end sleeves 0,5 - 6 mm², 2.700 insulated end sleeves, 1.100 insulated terminals in plastic bulk storage chest 415 x 335 x 90 mm.
 500 insulated end sleeves 0,5/8, white, art. 270801
 500 insulated end sleeves 0,75/8, grey, art. 270802
 500 insulated end sleeves 1/8, red, art. 270805
 500 insulated end sleeves 1,5/8, black, art. 270807
 500 insulated end sleeves 2,5/8, blue, art. 270811
 100 insulated end sleeves 4/10, grey, art. 270814
 100 insulated end sleeves 6/12, yellow, 270818
 200 insulated butt connectors 0,25-1,5, art. 260350
 200 insulated butt connectors 1,5-2,5, art. 260352
 100 insulated socket sleeves 0,25-1,5/6,3x0,8, art. 260392
 100 insulated socket sleeves 1,5-2,5/6,3x0,8, art. 260394
 100 insulated ring terminals 0,25-1,5, M5, art. 260258
 100 insulated ring terminals 1,5-2,5, M4, art. 260270
 100 insulated ring terminals 1,5-2,5, M5, art. 260272
 100 insulated ring terminals 1,5-2,5, M6, art. 260274
 100 insulated ring terminals 0,25-1,5, M4, art. 260256



Art. no.	Content	type	kg	PU
270895	3900	DIN	4,300	1
270896	3900	I	4,300	1
270897	3900	II	4,300	1

SysCon end sleeves & 210804



Content: 4100 insulated end sleeves

- 1 220370 ABS plastic box „SysCon S“
 - 1 220375 Assortment insert „SysCon“
 - 1 220399 Foam „SysCon“ 400 x 300 x 10 mm
 - 1 210804 Crimping pliers for end sleeves 0,08 - 10 mm²
- | | | | |
|------|--------|-------------------------------|--------|
| 1000 | 270805 | insulated end sleeves, red | 1/8 |
| 1000 | 270802 | insulated end sleeves, grey | 0,75/8 |
| 500 | 270807 | insulated end sleeves, black | 1,5/8 |
| 500 | 270811 | insulated end sleeves, blue | 2,5/8 |
| 500 | 270815 | insulated end sleeves, grey | 4/10 |
| 100 | 270818 | insulated end sleeves, yellow | 6/12 |
| 200 | 270788 | Twin-end sleeves, black | 1,5/8 |
| 200 | 270792 | Twin-end sleeves, blue | 2,5/10 |
| 100 | 270796 | Twin-end sleeves, grey | 4,0/12 |



SysCon end sleeves & 210842



Content: 4950 insulated end sleeves

- 1 220370 ABS plastic box „SysCon S“
 - 1 220399 Foam „SysCon“ 400 x 300 x 10 mm
 - 1 220375 Assortment insert „SysCon“
 - 1 210842 Crimping pliers for end sleeves 1 - 10 mm²
- | | | | |
|------|--------|-------------------------------|--------|
| 1000 | 270805 | insulated end sleeves, red | 1/8 |
| 1000 | 270807 | insulated end sleeves, black | 1,5/8 |
| 1000 | 270811 | insulated end sleeves, blue | 2,5/8 |
| 500 | 270815 | insulated end sleeves, grey | 4/10 |
| 200 | 270818 | insulated end sleeves, yellow | 6/12 |
| 200 | 270822 | insulated end sleeves, red | 10/12 |
| 500 | 270806 | insulated end sleeves, red | 1/12 |
| 300 | 270027 | insulated end sleeves, black | 1,5/18 |
| 250 | 270813 | insulated end sleeves, blue | 2,5/18 |



Art. no.	Content	kg	PU
220382	4100	4,300	1

Art. no.	Content	kg	PU
220390	4950	4,300	1



Insulated crimp terminals



INFO

The Quality

The elimination of every need to weld complicated operations to effect an electrical connection, the high productivity in cable termination, the low contact resistance as well as the high connection reliability are only some of the multiple advantages guaranteed by the HAUPA crimp systems.

Variety

The wide and complete range of crimp terminals satisfies the most different connection requirements with the widest application field even referring to the hardest and least favourable conditions of operation.

Materials

The high conductivity and the top mechanical characteristics are guaranteed by the purity (up to 99,9%) of the copper utilized for the production of crimp terminals.

Hot treatment

In order to ensure the maximum malleability of materials during the crimping operations all copper terminals undergo a hot treatment with forced ventilation and controlled temperature.

Surface treatment

The crimp terminals are treated with processes of electrolytic tin plating. This method guarantees the maximum adhesion of tin to the crimp terminal surface in order to reduce the electrical resistance to a minimum and to maximize the protection against corrosion.

Insulation

The standard models are available with insulation in special self-extinguishing PVC or in Nylon and in colours according to International Standards. The high quality of the insulation materials employed for all crimp terminals ensure a high degree of resistance to the mechanical solicitations that they must undergo during the crimping operations without alteration of their insulation characteristics.

PVC Insulated crimp terminals Easy Entry

1. Sleeves, made of purest copper
2. Treated with processes of electrolytic tin plating
3. Hot treatment
4. Internal serration for the best most electric contact
5. Insulation Easy Entry sleeve
6. Copper sleeve Easy Entry: for quick wire insertions with no strand turn-back and a strong mechanical retention.

Funnel shaped insulating sleeve

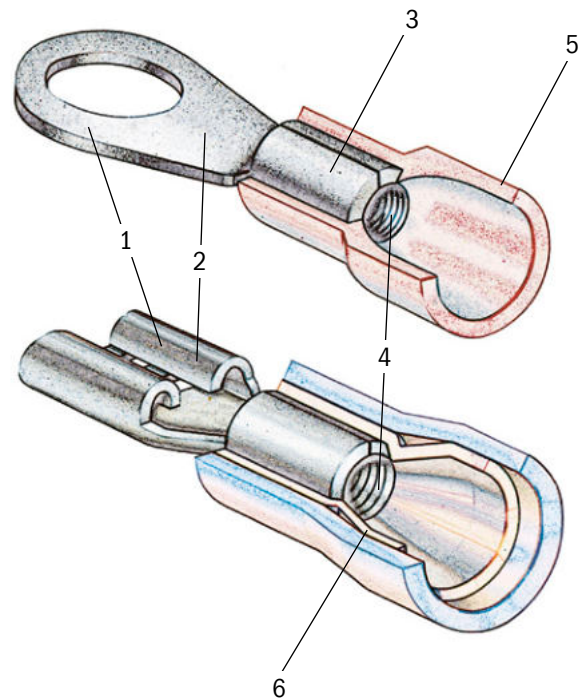

Underwriters Laboratories Inc.
Listed File E338116, E336314

Ring terminals DIN 46237

- of electrolytic copper, tin-plated, soldered • Easy Entry
- PVC-insulated, with expanded insulating sleeve, suitable for harmonised cables



Art. no.	CSS	M	d2	d1	d4	s1	A	TL	E	B	kg/100	PU	PU
260250	0,5 - 1,0	2,5	2,6	1,95	4,2	0,8	10,4	22,2	8,6	8,0	0,071	500	100
260252		3	3,2	1,95	4,2	0,8	10,4	15,4	4,4	5,5	0,072	500	100
260254		3,5	3,6	1,95	4,2	0,8	10,4	22,2	7,8	8,0	0,065	500	100
260256 *		4	4,2	1,95	4,2	0,8	10,4	22,0	7,5	8,0	0,079	500	100
260258 *		5	5,2	1,95	4,2	0,8	10,4	22,4	8,0	8,0	0,096	500	100
260260 *		6	6,2	1,95	4,2	0,8	10,4	23,7	8,6	10,0	0,106	500	100
260262		8	8,3	1,95	4,2	0,8	10,4	30,0	12,6	14,0	0,136	500	100
260264		10	10,4	1,95	4,2	0,8	10,4	30,0	12,8	14,0	0,190	500	100
260267	1,5 - 2,5	3	3,2	2,45	4,8	0,8	11,0	18,5	4,3	6,4	0,078	500	100
260268		3,5	3,7	2,45	4,8	0,8	11,0	23,0	8,0	8,0	0,078	500	100
260270 *		4	4,2	2,45	4,8	0,8	11,0	23,0	8,0	8,0	0,092	500	100
260272 *		5	5,2	2,45	4,8	0,8	11,0	26,0	9,8	10,0	0,111	500	100
260274 *		6	6,2	2,45	4,8	0,8	11,0	28,0	11,7	11,0	0,123	500	100
260276		8	8,2	2,45	4,8	0,8	11,0	33,0	14,5	15,0	0,147	500	100
260278		10	10,5	2,45	4,8	0,8	11,0	33,0	14,5	15,0	0,200	500	100
260282	4 - 6	3,5	3,7	3,5	6,6	1,0	14,0	26,5	8,4	8,0	0,163	500	100
260284		4	4,2	3,5	6,6	1,0	14,0	26,5	8,4	8,0	0,168	500	100
260286		5	5,2	3,5	6,6	1,0	14,0	29,6	10,2	10,0	0,186	500	100
260288 *		6	6,2	3,5	6,6	1,0	14,0	30,6	11,0	11,0	0,196	500	100
260290 *		8	8,2	3,5	6,6	1,0	14,0	37,0	15,3	15,0	0,243	500	100
260292		10	10,5	3,5	6,6	1,0	14,0	40,0	16,5	19,0	0,299	500	100

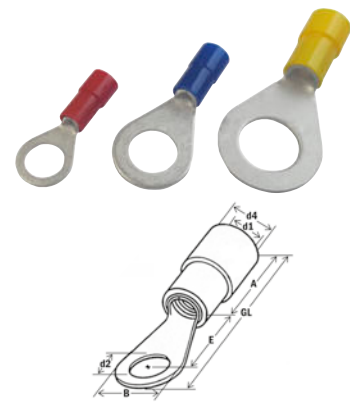

Fork terminals DIN 46237

- of electrolytic copper, tin-plated, soldered • Easy Entry
- PVC-insulated, with expanded insulating sleeve, suitable for harmonised cables



Art. no.	CSS	M	d2	d1	d4	s1	A	TL	E	B	kg/100	PU	PU
260300	0,5 - 1,0	3	3,2	1,95	4,2	0,8	10,4	20,0	6,7	5,6	0,065	500	100
260302		3,5	3,7	1,95	4,2	0,8	10,4	19,4	6,5	6,5	0,065	500	100
260304		4	4,2	1,95	4,2	0,8	10,4	20,9	6,3	6,4	0,070	500	100
260306		5	5,2	1,95	4,2	0,8	10,4	21,2	8,0	8,0	0,092	500	100
260308		6	6,2	1,95	4,2	0,8	10,4	22,4	8,3	9,2	0,101	500	100
260310	1,5 - 2,5	3	3,2	2,45	4,8	0,8	11,0	23,0	8,4	5,6	0,079	500	100
260312		3,5	3,7	2,45	4,8	0,8	11,0	20,3	5,3	6,6	0,085	500	100
260314		4	4,2	2,45	4,8	0,8	11,0	20,3	5,3	6,6	0,084	500	100
260316		5	5,2	2,45	4,8	0,8	11,0	25,0	9,5	9,1	0,109	500	100
260318		6	6,3	2,45	4,8	0,8	11,0	27,0	11,2	10,0	0,118	500	100
260320	4,0 - 6,0	4	4,2	3,5	6,6	1,0	14,0	26,0	7,2	8,1	0,116	500	100
260322		5	5,2	3,5	6,6	1,0	14,0	28,5	10,5	9,0	0,179	500	100
260324		6	6,3	3,5	6,6	1,0	14,0	29,5	11,0	11,0	0,188	500	100
260326		8	8,2	3,5	6,6	1,0	14,0	35,2	15,0	15,2	0,229	500	100
260328		10	10,5	3,5	6,6	1,0	14,0	38,0	16,6	19,0	0,291	500	100

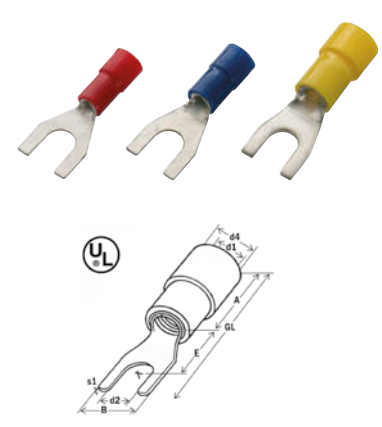

Socket sleeves (male) DIN 46231

- of electrolytic copper, tin-plated, soldered • Easy Entry
- PVC-insulated, with expanded insulating sleeve, suitable for harmonised cables



Art. no.	CSS	d1	d4	A	TL	E	B	kg/100	PU	PU
260330	0,5 - 1,0	1,7	4,2	10,4	19,4	9,0	2,8	0,058	500	100
260331		1,7	4,2	10,4	24,9	14,5	3,0	0,070	500	100
260332	1,5 - 2,5	2,3	4,8	10,4	19,4	9,0	2,8	0,066	500	100
260333		2,3	4,8	10,4	26,4	16,0	2,8	0,080	500	100
260334	4 - 6	3,4	6,8	13,5	23,5	10,0	2,8	0,120	500	100
260335		3,4	6,8	13,5	31,7	18,2	4,5	0,170	500	100

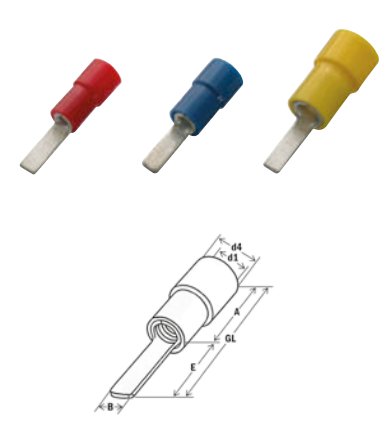

Butt connectors

- of electrolytic copper, tin-plated • Easy Entry
- PVC-insulated, with expanded insulating sleeve, suitable for harmonised cables



Art. no.	CSS	d1	d4	A	TL	kg/100	PU	PU
260350 *	0,5 - 1,0	1,7	4,0	15	22,7	0,110	500	100
260352 *	1,5 - 2,5	2,3	4,5	15	22,7	0,130	500	100
260354 *	4,0 - 6,0	3,4	6,8	15	26,7	0,230	500	100

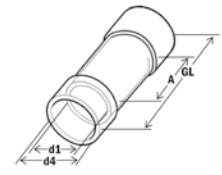

Parallel connectors

- of electrolytic copper, tin-plated • Easy Entry
- PVC-insulated, with expanded insulating sleeve, suitable for harmonised cables



Art. no.	CSS	d1	d4	A	TL	kg/100	PU	PU
260360	0,5 - 1,0	1,7	4,0	8,0	16,0	0,060	500	100
260362	1,5 - 2,5	2,3	4,5	8,0	16,0	0,080	500	100
260364	4,0 - 6,0	3,4	6,8	8,0	20,5	0,140	500	100

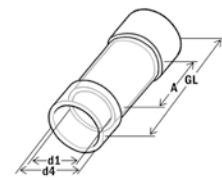

Round pins

- of electrolytic copper, tin-plated • Easy Entry
- PVC-insulated, with expanded insulating sleeve, suitable for harmonised cables



Art. no.	CSS	d1	d4	A	TL	E	B	kg/100	PU	PU
260370	0,5 - 1,0	1,95	4,20	10,4	22,4	12,0	1,8	0,070	500	100
260371		1,95	4,20	10,4	20,0	9,0	1,8	0,060	500	100
260372	1,5 - 2,5	2,45	4,8	11,0	23,0	12,0	1,8	0,080	500	100
260373		2,45	4,8	11,0	20,0	9,0	1,8	0,070	500	100
260374	4,0 - 6,0	3,5	6,6	14,0	28,0	14,0	2,6	0,170	500	100

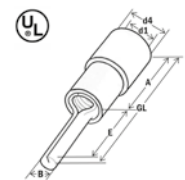

Socket sleeves (female)

- Brass, tin-plated, PVC-insulated
- with vibration-free copper sleeve • Easy Entry



Art. no.	CSS	plug	d1	A	TL	c	B	material	kg/100	PU	PU
260380	0,5 - 1,0	2,8x0,5	3,5	9,5	17,9	6,4	3,2	PVC	0,070	500	100
260382		2,8x0,8	3,5	9,5	17,9	6,4	3,2	PVC	0,070	500	100
260384		4,8x0,5	3,5	9,5	18,7	6,0	5,0	PVC	0,080	500	100
260386		4,8x0,8	3,5	9,5	18,7	6,0	5,0	PVC	0,080	500	100
260400		5,2x0,8	3,5	9,5	18,7	6,4	5,5	PVC	0,090	500	100
260392 *		6,3x0,8	3,5	9,5	20,5	7,8	6,6	PVC	0,100	500	100
260388	1,5 - 2,5	4,8x0,5	4,3	9,5	18,7	6,0	5,0	PVC	0,090	500	100
260390		4,8x0,8	4,3	9,5	18,7	6,0	5,0	PVC	0,090	500	100
260402		5,2x0,8	4,3	9,5	18,7	6,4	5,5	PVC	0,090	500	100
260394 *		6,3x0,8	4,3	9,5	20,5	7,8	6,6	PVC	0,120	500	100
260396 *	4,0 - 6,0	6,3x0,8	6,2	13,5	24,5	7,8	6,6	PVC	0,190	500	100
260404		9,8x1,1	6,2	13,5	29,2	12,0	10,0	PVC	0,260	500	100

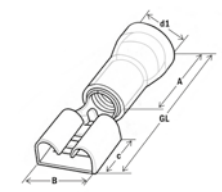

Socket sleeves (female) with branch

- Brass, tin-plated, PVC-insulated
- with vibration-free copper sleeve • Easy Entry



Art. no.	CSS	plug	d1	A	TL	A1	A2	B	B2	material	kg/100	PU	PU
260410	0,5 - 1,0	6,3x0,8	3,5	9,5	22,2	6,6	6,3	7,8	8,0	PVC	0,140	500	100
260412	1,5 - 2,5	6,3x0,8	4,3	9,5	22,2	6,8	6,3	7,8	8,0	PVC	0,150	500	100
260411	4,0 - 6,0	6,3x0,8	4,3	9,5	22,2	6,8	6,3	7,8	8,0	PVC	0,280	500	100

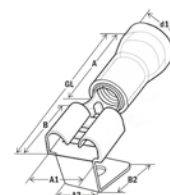

Socket sleeves (female), fully-insulated

- Brass, tin-plated, PVC-insulated
- with vibration-free copper sleeve • Easy Entry



Art. no.	CSS	plug	d1	A	TL	c	B	material	kg/100	PU	PU
260414	0,5 - 1,0	6,3x0,8	2,7	11,0	22,0	6,8	6,6	PVC	0,129	500	100
260415		4,8x0,8	2,7	11,0	20,0	6,0	5,0	PVC	0,100	500	100
260416	1,5 - 2,5	6,3x0,8	3,2	11,0	22,0	6,8	6,6	PVC	0,130	500	100
260417		4,8x0,8	3,2	11,0	20,0	6,0	5,0	PVC	0,110	500	100
260418	4,0 - 6,0	6,3x0,8	3,8	14,0	25,0	6,8	6,6	PVC	0,220	500	100

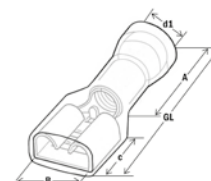

Flat terminals

- Brass, tin-plated, PVC-insulated
- with vibration-free copper sleeve • Easy Entry



Art. no.	CSS	plug	d1	A	TL	c	B	material	kg/100	PU	PU
260510	0,5 - 1,0	2,8x0,5	3,8	10,5	19,2	6,5	2,8	PVC	0,060	500	100
260512		2,8x0,8	3,8	10,5	19,2	6,5	2,8	PVC	0,065	500	100
260514		4,8x0,5	3,8	10,5	19,2	6,5	4,8	PVC	0,075	500	100
260516		4,8x0,8	3,8	10,5	19,2	6,7	4,8	PVC	0,080	500	100
260422 *		6,3x0,8	3,5	10,0	20,5	7,7	6,3	PVC	0,090	500	100
260518	1,5 - 2,5	4,8x0,5	3,8	10,5	19,2	6,5	4,8	PVC	0,085	500	100
260520		4,8x0,8	3,8	10,5	19,2	6,7	4,8	PVC	0,090	500	100
260424 *		6,3x0,8	4,0	10,0	20,5	7,7	6,3	PVC	0,100	500	100
260426 *	4,0 - 6,0	6,3x0,8	5,5	13,5	24,5	7,7	6,3	PVC	0,180	500	100

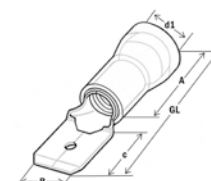

Round terminals

- of electrolytic copper, tin-plated • Easy Entry
- PVC-insulated, with expanded insulating sleeve, suitable for harmonised cables



Art. no.	CSS	plug	d1	A	TL	c	B	material	kg/100	PU	PU
260446	0,5 - 1,0	4 mm	3,5	9,5	20,2	8,7	4,0	PVC	0,090	500	100
260448	1,5 - 2,5	5 mm	4,3	9,5	20,7	8,7	5,0	PVC	0,110	500	100
260449		4 mm	4,3	9,5	20,2	8,7	4,0	PVC	0,100	500	100
260450	4,0 - 6,0	5 mm	6,5	13,5	25,0	10,0	5,0	PVC	0,170	500	100

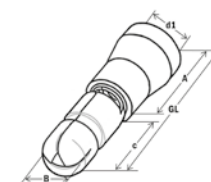

Round sleeves

- of electrolytic copper, tin-plated • Easy Entry
- PVC-insulated, with expanded insulating sleeve, suitable for harmonised cables



Art. no.	CSS	plug	d1	A	TL	c	B	material	kg/100	PU	PU
260440	0,5 - 1,0	4 mm	3,5	9,5	20,2	8,7	4,0	PVC	0,130	500	100
260442	1,5 - 2,5	5 mm	4,3	9,5	20,7	8,7	5,0	PVC	0,150	500	100
260443		4 mm	4,3	9,5	20,2	8,7	4,0	PVC	0,130	500	100
260444	4,0 - 6,0	5 mm	6,5	13,0	25,0	12,0	5,0	PVC	0,250	500	100

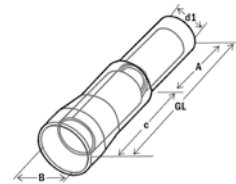

Rapid connectors

- of electrolytic copper, tin-plated
- Polypropylene

Art. no.	CSS	A	TL	kg/100	PU
260336 *	0,5 - 1,0	20,0	27,0	0,130	100
260500		9,8	37,0	0,100	100
260337	1,5 - 2,5	20,0	27,0	0,130	100
260502		9,8	37,0	0,120	100
260338	4,0 - 6,0	20,5	34,5	0,290	100
260504		9,8	37,0	0,140	100



Small packages

INFO

Counter display for small packages

Small package in resealable, transparent plastic packaging with blister hanger.

Ideally suited to sale on space-saving counter stands and small display units.



Counter display

- Ring terminals • Butt connectors
- Twin-end sleeves • Shrinkable connectors
- Socket sleeves (female)

Art. no.	Contents	L	W	H	kg	VE
300169	350 SmallPacks, various	410	580	180	9,500	1

Crimp terminals, PVC-insulated

Ring terminals DIN 46237 „SmallPack“

- of electrolytic copper, tin-plated • Easy Entry
- PVC-insulated, with expanded insulating sleeve, suitable for harmonised cables



Art. no.	CSS	M	d2	d1	d4	s1	A	TL	E	B	kg/100	PU
260256/10	0,5 - 1,0	4	4,2	1,95	4,2	0,8	10,4	22,0	7,5	8,0	0,096	100
260258/10		5	5,2	1,95	4,2	0,8	10,4	22,4	8,0	8,0	0,096	100
260270/10	1,5 - 2,5	4	4,2	2,45	4,8	0,8	11,0	23,0	8,0	8,0	0,092	100
260272/10		5	5,2	2,45	4,8	0,8	11,0	26,0	9,8	10,0	0,111	100
260274/10		6	6,2	2,45	4,8	0,8	11,0	28,0	11,7	11,0	0,123	100
260288/10	4,0 - 6,0	6	6,2	3,5	6,6	1,0	14,0	30,6	11,0	11,0	0,196	100
260290/10		8	8,2	3,5	6,6	1,0	14,0	37,0	15,3	15,0	0,243	100



Fork terminals DIN 46237 „SmallPack“

- of electrolytic copper, tin-plated • Easy Entry
- PVC-insulated, with expanded insulating sleeve, suitable for harmonised cables



Art. no.	CSS	M	d2	d1	d4	s1	A	TL	E	B	kg/100	PU
260304/10	0,5 - 1,0	4	4,2	1,95	4,2	0,8	10,4	20,9	6,3	6,4	0,100	100
260306/10		5	5,2	1,95	4,2	0,8	10,4	21,2	8,0	8,0	0,100	100
260314/10	1,5 - 2,5	4	4,2	2,45	4,8	0,8	11,0	20,3	5,3	6,6	0,100	100
260316/10		5	5,2	2,45	4,8	0,8	11,0	25,0	9,5	9,1	0,100	100
260324/10	4,0 - 6,0	6	6,3	3,5	6,6	1,0	14,0	29,5	11,0	11,0	0,200	100



Butt connectors „SmallPack“

- of electrolytic copper, tin-plated • Easy Entry
- PVC-insulated, with expanded insulating sleeve, suitable for harmonised cables



Art. no.	CSS	d1	d4	A	TL	kg/100	PU
260350/10	0,5 - 1,0	1,7	4,0	15	22,7	0,110	100
260352/10	1,5 - 2,5	2,3	4,5	15	22,7	0,130	100
260354/10	4,0 - 6,0	3,4	6,8	15	26,7	0,230	100



haupa®

...convincing solutions

Socket sleeves (female) „SmallPack“

- Brass, tin-plated, PVC-insulated
- with vibration-free copper sleeve • Easy Entry



Art. no.	CSS	plug	d1	A	TL	c	B	material	kg/100	PU	PU
260386/10	0,5 - 1,0	4,8x0,8	3,5	9,5	18,7	6,0	5,0	PVC	0,100	100	10
260392/10		6,3x0,8	3,5	9,5	20,5	7,8	6,6	PVC	0,100	100	10
260390/10	1,5 - 2,5	4,8x0,8	4,3	9,5	18,7	6,0	5,0	PVC	0,100	100	10
260394/10		6,3x0,8	4,3	9,5	20,5	7,8	6,6	PVC	0,120	100	10
260396/10	4,0 - 6,0	6,3x0,8	6,2	13,5	24,5	7,8	6,6	PVC	0,190	100	10



Socket sleeves (female), fully-insulated

- Brass, tin-plated, PVC-insulated
- with vibration-free copper sleeve • Easy Entry



Art. no.	CSS	plug	d1	A	TL	c	B	material	kg/100	PU	PU
260414/10	0,5 - 1,0	6,3x0,8	2,7	11,0	22,0	6,8	6,6	PVC	0,129	100	10
260416/10	1,5 - 2,5	6,3x0,8	3,2	11,0	22,0	6,8	6,6	PVC	0,130	100	10



Flat terminals „SmallPack“

- Brass, tin-plated, PVC-insulated
- with vibration-free copper sleeve • Easy Entry



Art. no.	CSS	plug	d1	A	TL	c	B	material	kg/100	PU	PU
260516/10	0,5 - 1,0	4,8x0,8	3,8	10,5	19,2	6,7	4,8	PVC	0,100	100	10
260422/10		6,3x0,8	3,5	10,0	20,5	7,7	6,3	PVC	0,090	100	10
260520/10	1,5 - 2,5	4,8x0,8	3,8	10,5	19,2	6,7	4,8	PVC	0,100	100	10
260424/10		6,3x0,8	4,0	10,0	20,5	7,7	6,3	PVC	0,100	100	10
260426/10	4,0 - 6,0	6,3x0,8	5,5	13,5	24,5	7,7	6,3	PVC	0,180	100	10



Round terminals „SmallPack“

- of electrolytic copper, tin-plated • Easy Entry
- PVC-insulated, with expanded insulating sleeve, suitable for harmonised cables



Art. no.	CSS	plug	d1	A	TL	c	B	material	kg/100	PU	PU
260448/10	0,5 - 1,0	6,3x0,8	2,7	11,0	22,0	6,8	6,6	PVC	0,129	100	10



Round sleeves „SmallPack“

- of electrolytic copper, tin-plated • Easy Entry
- PVC-insulated, with expanded insulating sleeve, suitable for harmonised cables



Art. no.	CSS	plug	d1	A	TL	c	B	material	kg/100	PU	PU
260442/10	1,5 - 2,5	5 mm	4,3	9,5	20,7	8,7	5,0	PVC	0,200	100	10



Ring terminals DIN 46237

- of electrolytic copper, tin-plated, soldered • Easy Entry
- Nylon-insulated, with expanded insulating sleeve, suitable for harmonised cables



Art. no.	CSS	M	d2	d1	d4	s1	A	TL	E	B	kg/100	PU
260243	0,2 - 0,5	2	2,2	1,00	2,3	0,5	8,0	16,5	6,0	5,0	0,050	500 100
260245		3	3,2	1,00	2,3	0,5	8,0	16,5	6,0	5,0	0,070	500 100
260246		3,5	3,7	1,00	2,3	0,5	8,0	16,5	8,0	6,0	0,070	500 100
260247		4	4,3	1,00	2,3	0,5	8,0	19,3	8,0	6,5	0,065	500 100
260248		5	5,3	1,00	2,3	0,5	8,0	20,0	8,0	8,0	0,040	500 100
260650	0,5 - 1,0	2,5	2,6	1,95	4,2	0,8	10,4	22,2	8,6	8,0	0,072	500 100
260651		3	3,2	1,95	4,2	0,8	10,4	22,2	8,6	8,0	0,070	500 100
260654		3,5	3,6	1,95	4,2	0,8	10,4	22,2	7,8	8,0	0,067	500 100
260656		4	4,2	1,95	4,2	0,8	10,4	22,0	7,5	8,0	0,079	500 100
260658		5	5,2	1,95	4,2	0,8	10,4	22,4	8,0	8,0	0,096	500 100
260660	1,5 - 2,5	6	6,2	1,95	4,2	0,8	10,4	23,7	8,6	10,0	0,105	500 100
260662		8	8,3	1,95	4,2	0,8	10,4	30,0	12,6	14,0	0,136	500 100
260664		10	10,4	1,95	4,2	0,8	10,4	30,0	12,8	14,0	0,103	500 100
260666		3	3,2	2,45	4,8	0,8	11,0	23,0	8,0	8,0	0,110	500 100
260667		3,5	3,7	2,45	4,8	0,8	11,0	23,0	8,0	8,0	0,080	500 100
260670	4,0 - 6,0	4	4,2	2,45	4,8	0,8	11,0	23,0	8,0	8,0	0,088	500 100
260672		5	5,2	2,45	4,8	0,8	11,0	26,0	9,8	10,0	0,107	500 100
260674		6	6,2	2,45	4,8	0,8	11,0	28,0	11,7	11,0	0,120	500 100
260676		8	8,2	2,45	4,8	0,8	11,0	33,0	14,5	15,0	0,142	500 100
260678		10	10,5	2,45	4,8	0,8	11,0	33,0	14,5	15,0	0,133	500 100
260682	4,0 - 6,0	3,5	3,7	3,5	6,6	1,0	14,0	26,5	8,4	8,0	0,150	500 100
260684		4	4,2	3,5	6,6	1,0	14,0	26,5	8,4	8,0	0,165	500 100
260686		5	5,2	3,5	6,6	1,0	14,0	29,6	10,2	10,0	0,182	500 100
260688		6	6,2	3,5	6,6	1,0	14,0	30,6	11,0	11,0	0,190	500 100
260690		8	8,2	3,5	6,6	1,0	14,0	37,0	15,3	15,0	0,237	500 100
260692	10	10,5	3,5	6,6	1,0	14,0	40,0	16,5	19,0	0,311	500 100	

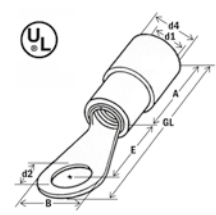

Fork terminals DIN 46237

- of electrolytic copper, tin-plated, soldered • Easy Entry
- Nylon-insulated, with expanded insulating sleeve, suitable for harmonised cables



Art. no.	CSS	M	d2	d1	d4	s1	A	TL	E	B	kg/100	PU
260700	0,5 - 1,0	3	3,2	1,95	4,2	0,8	10,4	20,0	6,7	5,6	0,068	500 100
260702		3,5	3,7	1,95	4,2	0,8	10,4	19,4	6,5	6,5	0,066	500 100
260704		4	4,2	1,95	4,2	0,8	10,4	20,9	6,3	6,4	0,071	500 100
260706		5	5,2	1,95	4,2	0,8	10,4	21,2	8,0	8,0	0,092	500 100
260708		6	6,2	1,95	4,2	0,8	10,4	22,4	8,3	9,2	0,080	500 100
260710	1,5 - 2,5	3	3,2	2,45	4,8	0,8	11,0	23,0	8,4	5,6	0,079	500 100
260712		3,5	3,7	2,45	4,8	0,8	11,0	20,3	5,3	6,6	0,086	500 100
260714		4	4,2	2,45	4,8	0,8	11,0	20,3	5,3	6,6	0,084	500 100
260716		5	5,2	2,45	4,8	0,8	11,0	25,0	9,5	9,1	0,110	500 100
260718		6	6,3	2,45	4,8	0,8	11,0	27,0	11,2	10,0	0,170	500 100
260721	4,0 - 6,0	4	4,2	3,5	6,6	1,0	14,0	26,0	7,2	8,1	0,157	500 100
260722		5	5,2	3,5	6,6	1,0	14,0	28,5	10,5	9,0	0,179	500 100
260724		6	6,3	3,5	6,6	1,0	14,0	29,5	11,0	11,0	0,190	500 100
260726		8	8,2	3,5	6,6	1,0	14,0	35,2	15,0	15,2	0,230	500 100
260728		10	10,5	3,5	6,6	1,0	14,0	38,0	16,6	19,0	0,273	500 100

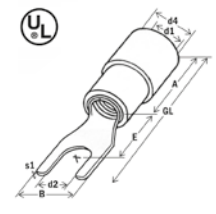

Socket sleeves (male) DIN 46231

- of electrolytic copper, tin-plated, soldered • Easy Entry
- Nylon-insulated, with expanded insulating sleeve, suitable for harmonised cables



Art. no.	CSS	d1	d4	A	TL	E	B	kg/100	PU
260730	0,5 - 1,0	1,7	4,2	10,4	19,4	9,0	2,8	0,059	500 100
260731		1,7	4,2	10,4	24,9	14,5	3,0	0,072	500 100
260732	1,5 - 2,5	2,3	4,8	10,4	19,4	9,0	2,8	0,067	500 100
260733		2,3	4,8	10,4	26,4	16,0	2,8	0,084	500 100
260734	4,0 - 6,0	3,4	6,8	13,5	23,5	10,0	2,8	0,160	500 100
260735		3,4	6,8	13,5	31,7	18,2	4,5	0,173	500 100

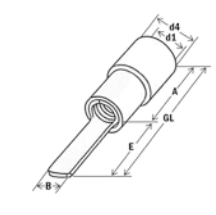

Butt connectors

- of electrolytic copper, tin-plated • Easy Entry
- Nylon-insulated, with expanded insulating sleeve, suitable for harmonised cables



Art. no.	CSS	d1	d4	A	TL	kg/100	PU	PU
260750	0,5 - 1,0	1,7	4,0	15,0	22,7	0,103	500	100
260752	1,5 - 2,5	2,3	4,5	15,0	22,7	0,128	500	100
260754	4,0 - 6,0	3,4	6,8	15,0	26,7	0,221	500	100

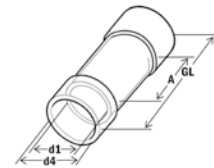

Parallel connectors

- of electrolytic copper, tin-plated • Easy Entry
- Nylon-insulated, with expanded insulating sleeve, suitable for harmonised cables



Art. no.	CSS	d1	d4	A	TL	kg/100	PU	PU
263360	0,5 - 1,0	1,7	4,0	8,0	16,0	0,069	500	100
263362	1,5 - 2,5	2,3	4,5	8,0	16,0	0,080	500	100
263364	4,0 - 6,0	3,4	6,8	8,0	16,0	0,150	500	100

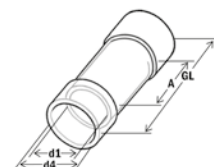

Round pins

- of electrolytic copper, tin-plated • Easy Entry
- Nylon-insulated, with expanded insulating sleeve, suitable for harmonised cables



Art. no.	CSS	d1	d4	A	TL	E	B	kg/100	PU	PU
260770	0,5 - 1,0	1,95	4,2	10,4	22,0	12	1,9	0,072	500	100
260771		1,95	4,2	10,4	20,0	9,0	1,9	0,064	500	100
260772	1,5 - 2,5	2,45	4,8	11,0	23,0	12,0	1,9	0,079	500	100
260773		2,45	4,8	11,0	20,0	9,0	1,9	0,074	500	100
260774	4,0 - 6,0	3,6	6,6	14,0	28,0	14,0	2,7	0,078	500	100
260376	10	4,5	8,3	21,5	38,0	15,0	4,0	0,300	500	100

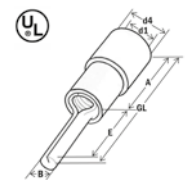

Socket sleeves (female)

- Brass, tin-plated, Nylon-insulated
- with vibration-free copper sleeve • Easy Entry



Art. no.	CSS	plug	d1	A	TL	c	B	material	kg/100	PU	PU
263380	0,5 - 1,0	2,8x0,5	3,5	9,5	17,9	6,4	3,2	Nylon	0,070	500	100
263382		2,8x0,8	3,5	9,5	17,9	6,4	3,2	Nylon	0,077	500	100
263384		4,8x0,5	3,5	9,5	18,7	6,0	5,0	Nylon	0,080	500	100
263386		4,8x0,8	3,5	9,5	18,7	6,0	5,0	Nylon	0,080	500	100
263400		5,2x0,8	3,5	9,5	18,7	6,4	5,5	Nylon	0,090	500	100
263392		6,3x0,8	3,5	9,5	20,5	7,8	6,6	Nylon	0,100	500	100
263388	1,5 - 2,5	4,8x0,5	4,3	9,5	18,7	6,0	5,0	Nylon	0,090	500	100
263393		4,8x0,8	4,3	9,5	18,7	6,0	5,0	Nylon	0,100	500	100
263402		5,2x0,8	4,3	9,5	18,7	6,4	5,5	Nylon	0,090	500	100
263394		6,3x0,8	4,3	9,5	20,5	7,8	6,6	Nylon	0,110	500	100
263396	4,0 - 6,0	6,3x0,8	6,2	13,5	24,5	7,8	6,6	Nylon	0,190	500	100
263404		9,8x1,1	6,2	13,5	29,2	12,0	10,0	Nylon	0,260	500	100

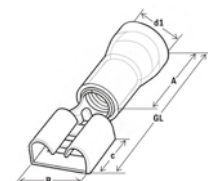

Socket sleeves (female) with branch

- Brass, tin-plated, Nylon-insulated
- with vibration-free copper sleeve • Easy Entry



Art. no.	CSS	plug	d1	A	TL	A1 A2	B	B2	material	kg/100	PU	PU
263410	0,5 - 1,0	6,3x0,8	3,5	9,5	22,2	6,8 6,3	7,8	8	Nylon	0,140	500	100
263412	1,5 - 2,5	6,3x0,8	4,3	9,5	22,2	6,8 6,3	7,8	8,0	Nylon	0,150	500	100
263413	4,0 - 6,0	6,3x0,8	4,3	9,5	22,2	6,8 6,3	7,8	8,0	Nylon	0,200	500	100

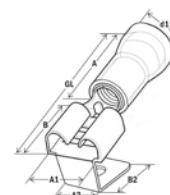

Socket sleeves (female), fully-insulated

- Brass, tin-plated, Nylon-insulated
- with vibration-free copper sleeve - Easy Entry



Art. no.	CSS	plug	d1	A	TL	c	B	material	kg/100	PU	PU
263451	0,5 - 1,0	2,8x0,5	4,0	11,0	19,5	6,5	3,2	Nylon	0,085	500	100
263452		2,8x0,8	4,0	11,0	19,5	6,5	3,2	Nylon	0,086	500	100
263453		4,8x0,5	4,0	11,0	20,2	6,4	5,0	Nylon	0,088	500	100
263414		6,3x0,8	4,0	11,0	21,5	7,5	6,6	Nylon	0,120	500	100
263415		4,8x0,8	4,0	11,0	20,2	6,4	5,0	Nylon	0,100	500	100
263456	1,5 - 2,5	4,8x0,5	5,0	11,0	20,2	6,4	5,0	Nylon	0,104	500	100
263416		6,3x0,8	5,0	11,0	21,5	7,5	6,6	Nylon	0,130	500	100
263417		4,8x0,8	5,0	11,0	20,2	6,4	5,0	Nylon	0,110	500	100
263418	4,0 - 6,0	6,3x0,8	6,5	13,0	24,2	7,5	6,6	Nylon	0,220	500	100

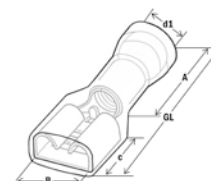

Flat terminals

- Brass, tin-plated, Nylon-insulated
- with vibration-free copper sleeve - Easy Entry



Art. no.	CSS	plug	d1	A	TL	c	B	material	kg/100	PU	PU
263510	0,5 - 1,0	2,8x0,5	3,8	10,5	19,2	6,5	2,8	Nylon	0,068	500	100
263512		2,8x0,8	3,5	10,5	19,2	6,5	2,8	Nylon	0,066	500	100
263514		4,8x0,5	3,8	10,5	10,5	6,5	4,8	Nylon	0,076	500	100
263516		4,8x0,8	3,8	10,5	19,2	6,7	4,8	Nylon	0,077	500	100
263422		6,3x0,8	3,5	10,0	20,5	7,7	6,3	Nylon	0,090	500	100
263518	1,5 - 2,5	4,8x0,5	3,8	10,5	19,2	6,5	4,8	Nylon	0,080	500	100
263520		4,8x0,8	3,8	10,5	19,2	6,7	4,8	Nylon	0,086	500	100
263424		6,3x0,8	4,0	10,0	20,5	7,7	6,3	Nylon	0,100	500	100
263426	4,0 - 6,0	6,3x0,8	5,5	13,5	24,5	7,7	6,3	Nylon	0,180	500	100

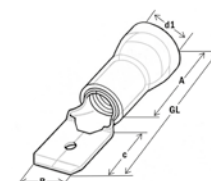

Round sleeves

- of electrolytic copper, tin-plated • Easy Entry
- Nylon-insulated, with expanded insulating sleeve, suitable for harmonised cables



Art. no.	CSS	plug	d1	A	TL	c	B	material	kg/100	PU	PU
263440	0,5 - 1,0	4 mm	3,5	9,5	20,2	8,7	4,0	Nylon	0,130	500	100
263442	1,5 - 2,5	5 mm	4,3	9,5	20,7	8,7	5,0	Nylon	0,150	500	100
263443		4 mm	4,3	9,5	20,2	8,7	4,0	Nylon	0,130	500	100

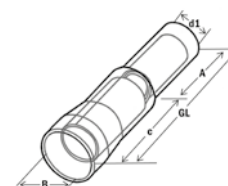

Round terminals

- of electrolytic copper, tin-plated • Easy Entry
- Nylon-insulated, with expanded insulating sleeve, suitable for harmonised cables



Art. no.	CSS	plug	d1	A	TL	c	B	material	kg/100	PU	PU
263446	0,5 - 1,0	4 mm	3,5	9,5	20,2	8,7	4,0	Nylon	0,090	500	100
263448	1,5 - 2,5	5 mm	4,3	9,5	20,7	8,7	5,0	Nylon	0,110	500	100
263449		4 mm	4,3	9,5	20,2	8,7	4,0	Nylon	0,100	500	100
263450	4,0 - 6,0	5 mm	6,5	13,5	25,0	10,0	5,0	Nylon	0,200	500	100

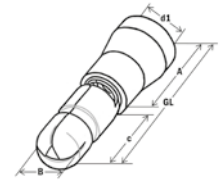

End connectors

- of electrolytic copper, tin-plated
- Nylon-insulated



Art. no.	CSS	d1	d4	A	TL	B	kg/100	PU	PU
260427 *	0,5 - 1,0	6,2	2,2	8,0	15,2	5,0	0,060	500	100
260428	1,5 - 2,5	6,5	2,5	8,0	15,2	5,9	0,065	500	100
260430	4,0 - 6,0	9,4	3,5	8,5	17,8	7,3	0,125	500	100
260431	10	12,0	4,6	9,5	22,2	9,3	0,260	500	100

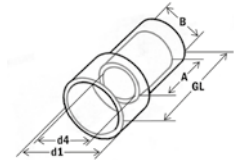

Ring terminals DIN 46237

- of electrolytic copper, tin-plated, soldered • suitable for harmonised cables
- PC-insulated, with expanded insulating sleeve • Easy Entry



Art. no.	CSS	M	d2	d1	d4	s1	A	TL	E	B	kg/100	PU	PU
340256	0,5 - 1,0	4	4,3	1,6	4,0	0,8	11,0	22,0	7,0	8,0	0,170	500	100
340258		5	5,3	1,6	4,0	0,8	11,0	24,0	8,0	10,0	0,220	500	100
340270	1,5 - 2,5	4	4,3	2,3	4,5	0,8	11,0	22,0	7,0	8,0	0,220	500	100
340272		5	5,3	2,3	4,5	0,8	11,0	25,0	9,0	10,0	0,250	500	100
340274		6	6,5	2,3	4,5	0,8	11,0	27,5	11,0	11,0	0,130	500	100
340288	4,0 - 6,0	6	6,5	3,6	6,4	1,0	13,0	28,5	10,0	11,0	0,200	500	100
340290		8	8,4	3,6	6,4	1,0	13,0	33,0	13,0	14,0	0,280	500	100

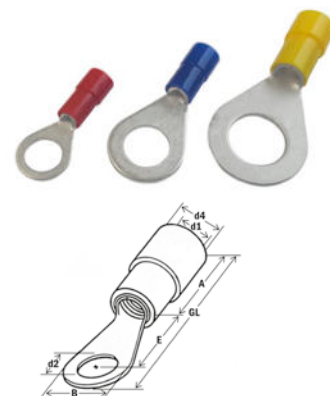

Fork terminals DIN 46237

- of electrolytic copper, tin-plated, soldered • suitable for harmonised cables
- PC-insulated, with expanded insulating sleeve • Easy Entry



Art. no.	CSS	M	d2	d1	s1	A	TL	E	B	kg/100	PU	PU
340304	0,5 - 1,0	4	4,3	1,6	0,8	11,0	22,3	7,0	6,6	0,105	500	100
340314	1,5 - 2,5	4	4,3	2,3	0,8	11,0	22,3	7,0	6,6	0,200	500	100
340322	4,0 - 6,0	6	6,5	3,6	1,0	13,0	29,5	10,0	10,7	0,220	500	100

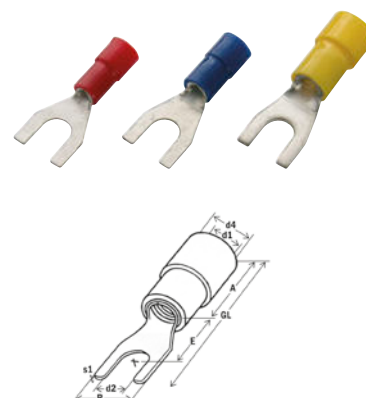

Butt connectors

- of electrolytic copper, tin-plated, soldered • suitable for harmonised cables
- PC-insulated, with expanded insulating sleeve • Easy Entry



Art. no.	CSS	d1	d4	A	TL	kg/100	PU	PU
340350	0,5 - 1,0	1,7	4,0	14,7	25,0	0,110	500	100
340352	1,5 - 2,5	2,3	4,5	14,7	25,0	0,130	500	100
340354	4,0 - 6,0	3,4	6,3	14,7	27,0	0,240	500	100

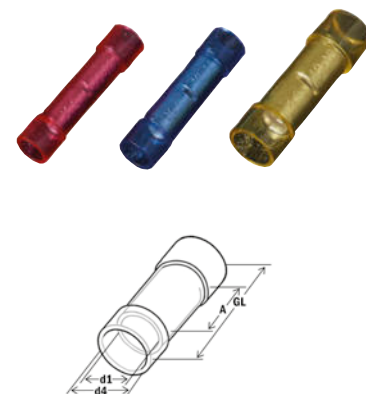

Socket sleeves (female)

- Brass, tin-plated • PC-insulated
- with vibration-free copper sleeve • Easy Entry



Art. no.	CSS	plug	d1	A	TL	c	B	kg/100	PU	PU
340392	0,5 - 1,0	6,3x0,8	4,0	11,0	21,5	7,5	6,6	0,080	500	100
340394	1,5 - 2,5	6,3x0,8	4,5	11,0	21,5	7,5	6,6	0,085	500	100
340396	4,0 - 6,0	6,3x0,8	6,3	13,0	23,5	7,5	6,6	0,230	500	100

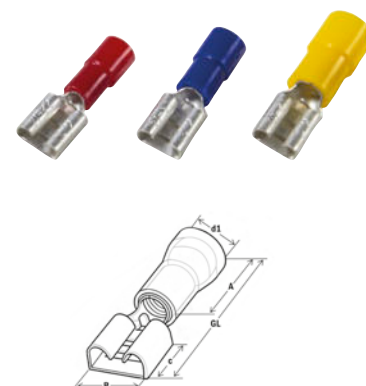

Socket sleeves (female), fully-insulated

- Brass, tin-plated • PC-insulated
- with vibration-free copper sleeve • Easy Entry



Art. no.	CSS	plug	d1	A	TL	c	B	material	kg/100	PU	PU
340414	0,5 - 1,0	6,3x0,8	4,0	10,0	21,5	7,5	6,6	PC	0,090	500	100
340416	1,5 - 2,5	6,3x0,8	4,5	10,0	21,5	7,5	6,6	PC	0,100	500	100

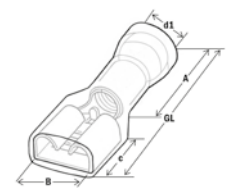

Flat terminals

- Brass, tin-plated • PC-insulated
- with vibration-free copper sleeve • Easy Entry



Art. no.	CSS	plug	d1	A	TL	c	B	material	kg/100	PU	PU
340422	0,5 - 1,0	6,3x0,8	4,0	11,0	22,0	7,7	6,35	PC	0,150	500	100
340424	1,5 - 2,5	6,3x0,8	4,5	11,0	22,0	7,7	6,35	PC	0,155	500	100
340426	4,0 - 6,0	6,3x0,8	6,3	13,0	24,0	7,7	6,35	PC	0,260	500	100

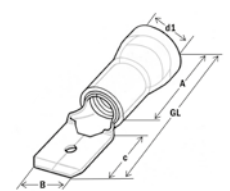

Ring terminals “ECO-Line”

• of electrolytic copper, tin-plated, not soldered • PVC-insulated, with expanded insulating sleeve • suitable for harmonised cables



Art. no.	CSS	M	d2	d1	d4	s1	A	TL	E	B	kg/100	PU	PU
370256	0,5 - 1,0	4	4,3	1,7	4,0	0,75	10,0	19,4	6,3	6,6	0,130	500	100
370258		5	5,3	1,7	4,0	0,75	10,0	20,8	7,0	8,0	0,130	500	100
370270	1,5 - 2,5	4	4,3	2,3	4,5	0,8	10,0	19,4	6,3	6,6	0,150	500	100
370272		5	5,3	2,3	4,5	0,8	10,0	21,8	7,8	8,5	0,170	500	100
370274		6	6,4	2,3	4,5	0,8	10,0	26,8	11,0	12,0	0,135	500	100
370288	4,0 - 6,0	6	6,4	2,3	4,5	0,8	10,0	26,8	11,0	12,0	0,210	500	100
370290		8	8,4	3,4	6,4	1,0	13,0	34,0	13,3	15,0	0,260	500	100

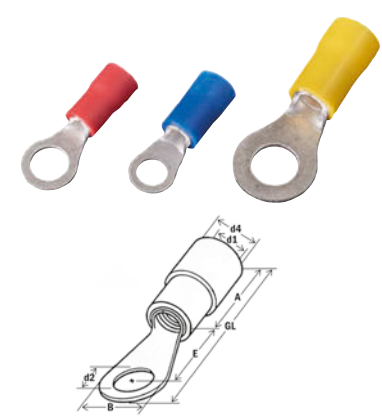

Fork terminals “ECO-Line”

• of electrolytic copper, tin-plated, not soldered • PVC-insulated, with expanded insulating sleeve • suitable for harmonised cables



Art. no.	CSS	M	d2	d1	d4	s1	A	TL	E	B	kg/100	PU	PU
370304	0,5 - 1,0	4	4,3	1,7	4,0	0,75	10,0	21,0	6,5	6,4	0,150	500	100
370314	1,5 - 2,5	4	4,3	2,3	4,5	0,8	10,0	21,0	6,5	6,4	0,170	500	100
370322	4,0 - 6,0	6	6,4	3,4	6,4	1,0	13,0	25,5	7,0	9,0	0,160	500	100

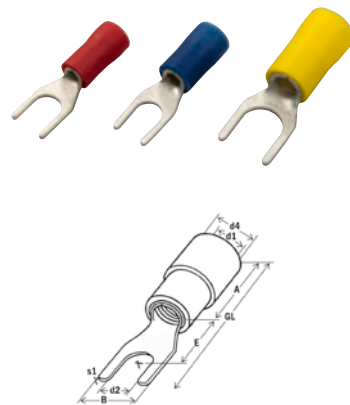

Butt connectors “ECO-Line”

• of electrolytic copper, tin-plated • PVC-insulated, with expanded insulating sleeve • suitable for harmonised cables



Art. no.	CSS	d1	d4	A	TL	kg/100	PU	PU
370350	0,5 - 1,0	1,7	4,0	14	24,6	0,081	500	100
370352	1,5 - 2,5	2,5	4,5	14	24,6	0,103	500	100
370354	4,0 - 6,0	3,4	6,3	14	26,5	0,173	500	100

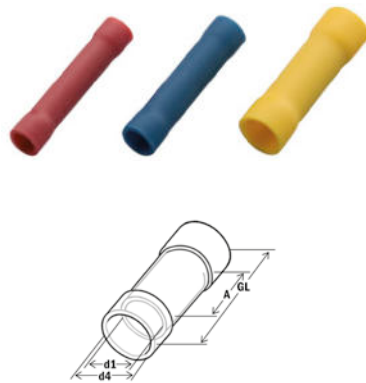

Socket sleeves (female) “ECO-Line”

• Brass, tin-plated • PVC-insulated • with vibration-free copper sleeve



Art. no.	CSS	plug	d1	A	TL	c	B	material	kg/100	PU	PU
370392	0,5 - 1,0	6,3x0,8	4,0	10,0	20,5	7,5	6,6	PVC	0,070	500	100
370394	1,5 - 2,5	6,3x0,8	4,5	10,0	20,5	7,5	6,6	PVC	0,077	500	100
370396	4,0 - 6,0	6,3x0,8	5,5	13,0	23,5	7,5	6,6	PVC	0,097	500	100

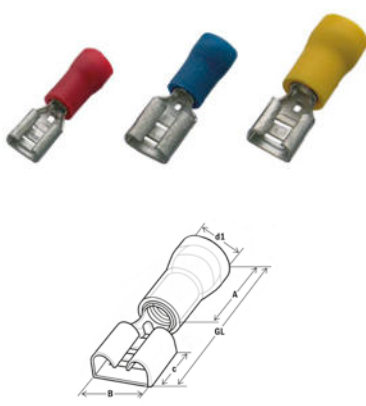

Socket sleeves (female), fully-insulated "ECO-Line"

- Brass, tin-plated • PVC-insulated
- with vibration-free copper sleeve



Art. no.	CSS	plug	d1	A	TL	c	B	material	kg/100	PU	PU
370414	0,5 - 1,0	6,3x0,8	4,0	10,0	22,0	7,5	6,6	PVC	0,113	500	100
370416	1,5 - 2,5	6,3x0,8	4,5	10,0	22,0	7,5	6,6	PVC	0,102	500	100

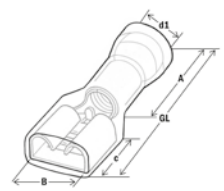

Flat terminals "ECO-Line"

- Brass, tin-plated • PVC-insulated
- with vibration-free copper sleeve



Art. no.	CSS	plug	d1	A	TL	c	B	material	kg/100	PU	PU
370422	0,5 - 1,0	6,3x0,8	4,0	10,0	21,0	7,7	6,35	PVC	0,058	500	100
370424	1,5 - 2,5	6,3x0,8	4,5	10,0	21,0	7,7	6,35	PVC	0,064	500	100
370426	4,0 - 6,0	6,3x0,8	5,5	13,0	24,0	7,7	6,35	PVC	0,088	500	100

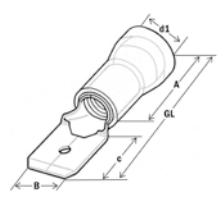

INFO

Shrinkable connectors

These shrinkable connectors are an insulated connecting element for the production of cable connections and circuit points. Their outstanding properties are based on the use of a Polyolefin shrinkable tube, which is coated with a special adhesive on the inside, which protects the metal crimp connections from environmental influences. These connectors or terminal clamps are used wherever a reliable connection is needed under severe environmental conditions.

The shrinkable connectors of the HAUPA-SHRINK series combine crimp technology with the completely waterproof shrink technology in one part: crimp first – **then shrink and make waterproof!**

USE: To create simple, durable and weatherproof electrical connections. Particularly suitable well as in the motor vehicle, agricultural machinery and commercial vehicle sector.

SPECIAL FEATURE: The fusible inside adhesive cover provides excellent durability and is safer than traditional connectors.

SUITABLE FOR MAKING WATERPROOF CONNECTIONS: • Shrink ratio 3:1 • Shrink temperature: >+125°C
• Temperature resistance: -55°C to + 125°C • Insulating sleeve: Polyolefin with inside adhesive
• Non-halogen • RoHS conform • No additional insulating and sealing required • Waterproof splice connection
• Space-saving and compact • Extremely high strain relief • Easy installation • Full visual testing possible

INSTRUCTIONS: The connector is crimped and then shrunk using a hot air blower (with deflector page 200). The connection Check whether the fusible inside adhesive comes out on the sides to ensure optimal tightness.

Butt connectors

- Copper, tin-plated • Insulating cover: Polyolefin with inside adhesive
- RoHS conform

Art. no.	CSS	A	TL	kg/100	PU	PU
363500 *	0,5 - 1,0	14	36	0,120	500	100
363502 *	1,5 - 2,5	15	36	0,132	500	100
363504 *	4,0 - 6,0	15	41	0,300	500	100

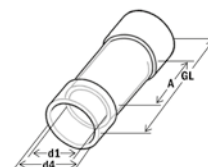

Socket sleeves (female)

- Brass, tin-plated • Insulating cover: Polyolefin with inside adhesive
- RoHS conform

Art. no.	CSS	plug	TL	B	kg/100	PU	PU
363510	0,5 - 1,0	6,3x0,8	30,0	6,6	0,129	500	100
363512	1,5 - 2,5	6,3x0,8	30,0	6,6	0,138	500	100
363514	4,0 - 6,0	6,3x0,8	30,0	6,6	0,200	500	100

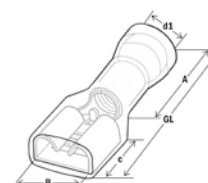

Flat terminals

- Brass, tin-plated • Insulating cover: Polyolefin with inside adhesive
- RoHS conform

Art. no.	CSS	plug	TL	B	kg/100	PU	PU
363520	0,5 - 1,0	6,3x0,8	30,0	6,6	0,092	500	100
363522	1,5 - 2,5	6,3x0,8	30,0	6,6	0,106	500	100
363524	4,0 - 6,0	6,3x0,8	30,0	6,6	0,159	500	100

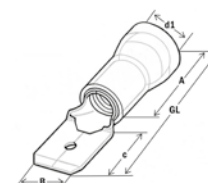

haupa[®]

...convincing solutions

Ring terminals

- Copper, tin-plated • Insulating cover: Polyolefin with inside adhesive
- RoHS conform

Art. no.	CSS	M	d2	TL	B	kg/100	PU	PU
363530	0,5 - 1,0	4	4,3	28,5	8,0	0,073	500	100
363532		5	5,3	28,5	8,0	0,066	500	100
363534		6	6,5	34,5	11,6	0,104	500	100
363536		8	8,4	34,5	11,6	0,089	500	100
363538		10	10,5	37,5	13,6	0,112	500	100
363540	1,5 - 2,5	4	4,3	30,5	8,5	0,085	500	100
363542		5	5,3	30,5	9,5	0,083	500	100
363544		6	6,5	35,5	12,0	0,122	500	100
363546		8	8,4	35,5	12,0	0,118	500	100
363548		10	10,5	37,5	13,6	0,128	500	100
363550	4,0 - 6,0	4	4,3	34,2	9,5	0,173	500	100
363552		5	5,3	34,0	9,5	0,172	500	100
363554		6	6,5	37,5	12,0	0,201	500	100
363556		8	8,4	42,0	15,0	0,251	500	100
363558		10	10,5	42,0	15,0	0,226	500	100

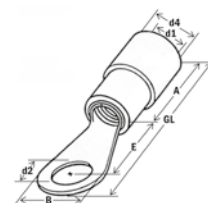

Shrink connectors

Butt connectors „SmallPack“

- Copper, tin-plated • RoHS-conform
- Insulating cover: Polyolefin with inside adhesiver

Art. no.	CSS	A	TL	kg/100	PU	PU
363500/10	0,5 - 1,0	14	36	0,120	100	10
363502/10	1,5 - 2,5	15	36	0,132	100	10
363504/5	4,0 - 6,0	15	41	0,300	50	5



Welded shrink connectors

Welded shrink connectors

- Copper, tin-plated • Insulating cover: Polyolefin with inside adhesive
- RoHS conform

Art. no.	CSS	d4	TL	kg/100	PU	PU
363600	0,5 - 1,0	4,2	37	0,090	500	100
363602	1,5 - 2,5	4,7	37	0,110	500	100
363604	4,0 - 6,0	6,0	42	0,160	500	100



Welded shrink connector, transparent

- Copper, tin-plated • RoHS conform
- Insulating cover: Polyolefin with inside adhesive • transparent

Art. no.	CSS	d1	A	TL	kg/100	PU	PU
363606	0,5 - 1,0	2,7	15,2	42	0,090	500	100
363607	1,5 - 2,5	4,5	15,2	42	0,110	500	100
363608	4,0 - 6,0	6,0	15,2	42	0,160	500	100

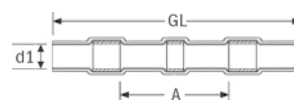

Assortment of insulated terminals

Content: 1.250 crimping terminals, crimping pliers (art. no. 210761), crimp 0,5 - 6,0 mm², in plastic bulk storage chest 415 x 335 x 90 mm.
 100 insulated ring terminals 0,25-1,5 M3 260252
 100 insulated ring terminals 0,25-1,5 M4 260256
 100 insulated ring terminals 0,25-1,5 M5 260258
 100 insulated ring terminals 1,5-2,5 M4 260270
 100 insulated ring terminals 1,5-2,5 M5 260272
 50 insulated ring terminals 1,5-2,5 M6 260274
 100 insulated ring terminals 2,5-6 M5 260286
 50 insulated ring terminals 2,5-6 M6 260288
 50 insulated fork type 0,25-1,5 M4 260304
 50 insulated fork type 1,5-2,5 M4 260314
 50 insulated fork type 2,5-6 M5 260322
 50 insulated butt connectors 0,25-1,5 260350
 50 insulated butt connectors 1,5-2,5 260352
 50 insulated butt connectors 2,5-6 260354
 50 insulated round pin 0,25-1,5 260370
 50 insulated round pin 1,5-2,5 260372
 50 insulated round pin 2,5-6 260374
 50 insul. socket sl. 1,5-2,5/6,3x0,8 260394
 50 insul. flat term. 1,5-2,5/6,3x0,8 260424



Art. no.	Content	Insulation	kg	PU
260762	1250	PVC	3,139	1

Assortment of insulated terminals

Content: 1250 insulated terminals, 1 crimping pliers (art. 210802), press range 1.5 - 6 mm², in plastic bulk storage chest.
 100 insulated ring terminals 0,25-1,5, M3, art. 260252
 100 insulated ring terminals 0,25-1,5, M4, art. 260256
 100 insulated ring terminals 0,25-1,5, M5, art. 260258
 100 insulated ring terminals 1,5-2,5, M4, art. 260270
 100 insulated ring terminals 1,5-2,5, M5, art. 260272
 50 insulated ring terminals 1,5-2,5, M6, art. 260274
 100 insulated ring terminals 2,5-6, M5, art. 260286
 50 insulated ring terminals 2,5-6, M6, art. 260288
 50 insulated fork type 0,25-1,5, M4, art. 260304
 50 insulated fork type 1,5-2,5, M4, art. 260314
 50 insulated fork type 2,5-6, M5, art. 260322
 50 insulated butt connectors 0,25-1,5, art. 260350
 50 insulated butt connectors 1,5-2,5, art. 260352
 50 insulated butt connectors 2,5-6, art. 260354
 50 insulated round pin 0,25-1,5, art. 260370
 50 insul. round pin 1,5-2,5, art. 260372
 50 insul. round pin 2,5-6, art. 260374
 50 insul. socket sleeves 1,5-2,5/6,3x0,8, art. 260394
 50 insul. flat terminals 1,5-2,5/6,3x0,8, art. 260424



Art. no.	Content	Insulation	kg	PU
260764	1250	PVC	3,278	1
262048	1250	PVC	-	3,400

Assortment of insulated terminals

Content: 1.200 Crimping terminals, 1 crimping pliers for insulated crimping terminals (art. 210761), range 0.5 - 6 mm² in plastic bulk storage chest.
 100 insulated ring terminals 0,25-1,5, M4, art. 260256
 100 insulated ring terminals 0,25-1,5, M5, art. 260258
 100 insulated ring terminals 0,25-1,5, M6, art. 260260
 100 insulated ring terminals 1,5-2,5, M4, art. 260270
 100 insulated ring terminals 1,5-2,5, M5, art. 260272
 100 insulated ring terminals 1,5-2,5, M6, art. 260274
 100 insulated ring terminals 2,5-6, M5, art. 260286
 100 insulated ring terminals 2,5-6, M6, art. 260288
 100 insulated ring terminals 2,5-6, M8, art. 260290
 100 insulated butt connectors 0,25-1,5, art. 260350
 100 insulated butt connectors 1,5-2,5, art. 260352
 100 insulated butt connectors 2,5-6, art. 260354



Art. no.	Content	Insulation	kg	PU
260765 *	1200	PVC	3,367	1

Assortment of insulated terminals

Content: 1.200 crimping terminals, crimping pliers (art. 210802), crimp 0,5 - 6,0 mm², in plastic bulk storage chest 415 x 335 x 90 mm.
 100 insulated ring terminals 0,25-1,5, M4, art. 260256
 100 insulated ring terminals 0,25-1,5, M5, art. 260258
 100 insulated ring terminals 0,25-1,5, M6, art. 260260
 100 insulated ring terminals 1,5-2,5, M4, art. 260270
 100 insulated ring terminals 1,5-2,5, M5, art. 260272
 100 insulated ring terminals 1,5-2,5, M6, art. 260274
 100 insulated ring terminals 2,5-6, M5, art. 260286
 100 insulated ring terminals 2,5-6, M6, art. 260288
 100 insulated ring terminals 2,5-6, M8, art. 260290
 100 insulated butt connectors 0,25-1,5, art. 260350
 100 insulated butt connectors 1,5-2,5, art. 260352
 100 insulated butt connectors 2,5-6, art. 260354



Art. no.	Content	Insulation	kg	PU
260777 *	1200	PVC	2,980	1

SysCon insulated terminals & 210761



Content: 1500 insulated terminals

- 1 220370 ABS plastic box „SysCon S“
- 1 220375 Assortment insert „SysCon“
- 1 220399 Foam „SysCon“ 400 x 300 x 10 mm
- 1 210761 Crimping pliers for insulated terminals 0,5 – 6 mm²

200	260350	Butt connectors, red	0,5/1,0	PVC
200	260352	Butt connectors, blue	1,5/2,5	PVC
100	260354	Butt connectors, yellow	4,0/6,0	PVC
200	260256	Ring terminals, red	0,5/1,0	M4 PVC
200	260258	Ring terminals, red	0,5/1,0	M5 PVC
200	260270	Ring terminals, blue	1,5/2,5	M4 PVC
200	260272	Ring terminals, blue	1,5/2,5	M5 PVC
100	260288	Ring terminals, yellow	4,0/6,0	M6 PVC
100	260290	Ring terminals, yellow	4,0/6,0	M8 PVC



SysCon insulated terminals / end sleeves & 210784



Content: insulated terminals and end sleeves

- 1 220370 ABS plastic box „SysCon S“
- 1 220375 Assortment insert „SysCon“
- 1 220399 Foam „SysCon“ 400 x 300 x 10 mm
- 1 210784 Crimping pliers for insulated terminals and end sleeves

200	260350	Butt connectors, red	0,5-1,0	PVC
200	260352	Butt connectors, blue	1,5-2,5	PVC
200	260256	Ring terminals, red	0,5-1,0	M4 PVC
200	260272	Ring terminals, blue	1,5-2,5	M5 PVC
200	260274	Ring terminals, blue	1,5-2,5	M6 PVC
1000	270807	End sleeves, black	1,5/8	
1000	270811	End sleeves, blue	2,5/8	
500	270815	End sleeves, grey	4/10	
200	270818	End sleeves, yellow	6/12	



Art. no.	Content	kg	PU
220381	1500	4,300	1

Art. no.	Content	kg	PU
220391	3700	4,300	1

Socket sleeves



Socket sleeves (male and female)

Socket sleeves (female)

- bare brass
- not insulated, to DIN 46247/part 1 - 3 and similar

Art. no.	CSS	plug	TL	c	B	kg/100	PU
280000	0,5 - 1	6,3x0,8	19,2	7,6	7,6	0,073	200
280004	1 - 2,5	6,3x0,8	19,2	7,6	7,6	0,079	200
280008	0,5 - 1,25	4,8x0,8	15,0	6,4	5,6	0,075	200
280012		4,8x0,5	15,0	6,4	5,6	0,043	200
280016		2,8x0,8	16,0	6,4	3,75	0,040	200
280020		2,8x0,5	16,0	6,4	3,75	0,020	200

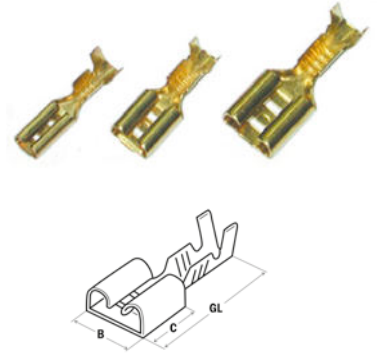

Socket sleeves (female)

- bare brass
- not insulated, to DIN 46247/part 1 - 3 and similar

Art. no.	CSS	plug	TL	c	B	kg/100	PU
280030	0,5 - 1,0	6,3x0,8	19,2	7,6	7,6	0,073	200
280034	1,0 - 2,5	6,3x0,8	19,2	7,6	7,6	0,038	200
280038	0,5 - 1,25	4,8x0,8	15,0	6,4	5,6	0,041	200
280042		4,8x0,5	15,0	6,4	5,6	0,027	200
280046		2,8x0,8	16,0	6,4	3,75	0,023	200
280050		2,8x0,5	16,0	6,4	3,75	0,027	200

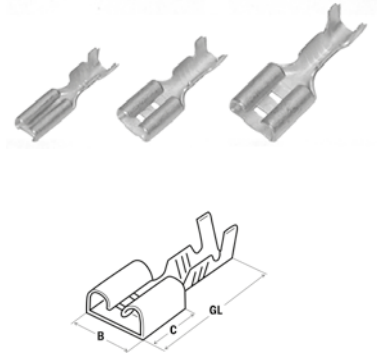

Socket sleeves (female)

- bare brass
- not insulated, to DIN 46247/part 1 - 3 and similar

Art. no.	CSS	plug	TL	c	B	kg/100	PU
280060	0,5 - 1,0	6,3x0,8	14,1	7,6	7,6	0,073	200
280064	1,0 - 2,5	6,3x0,8	14,1	7,6	7,6	0,078	200

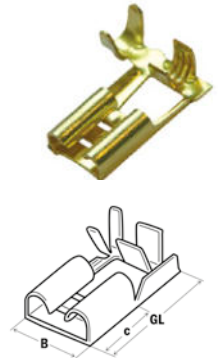

Socket sleeves (female)

- bare brass
- not insulated, to DIN 46247/part 1 - 3 and similar

Art. no.	CSS	plug	TL	c	B	kg/100	PU
280070	0,5 - 1,0	6,3x0,8	14,1	7,6	7,6	0,075	200
280074	1,0 - 2,5	6,3x0,8	14,1	7,6	7,6	0,078	200

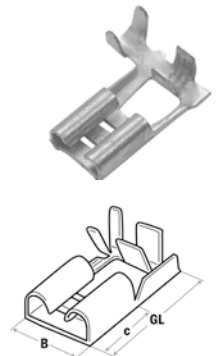

Socket sleeves (female) with branch

- bare brass
- not insulated, to DIN 46247/part 1 - 3 and similar

Art. no.	CSS	plug	TL	c	B	kg/100	PU
280080	0,5 - 1,0	6,3x0,8	19,6	7,7	7,6	0,108	200
280084	1,0 - 2,5	6,3x0,8	16,2	7,7	7,6	0,103	200

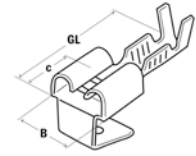

Socket sleeves (female) with branch

- bare brass
- not insulated, to DIN 46247/part 1 - 3 and similar

Art. no.	CSS	plug	TL	c	B	kg/100	PU
280090	0,5 - 1,0	6,3x0,8	19,6	7,7	7,6	0,110	200
280094	1,0 - 2,5	6,3x0,8	16,2	7,7	7,6	0,112	200

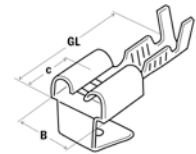

Flat terminals

- bare brass
- uninsulated

Art. no.	CSS	plug	TL	c	B	kg/100	PU
280100	0,5 - 1,0	6,3x0,8	20,6	6,35	6,3	0,055	200
280104	1,0 - 2,5	6,3x0,8	17,2	6,35	6,3	0,057	200

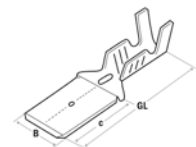

Flat terminals

- tin-plated brass
- uninsulated

Art. no.	CSS	plug	TL	c	B	kg/100	PU
280110	0,5 - 1,0	6,3x0,8	20,6	6,35	6,3	0,054	200
280114	1,0 - 2,5	6,3x0,8	17,2	6,35	6,3	0,057	200

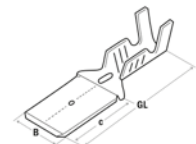

Socket sleeves (male and female)

Socket sleeves (male) with latching tongue

- bare brass
- uninsulated

Art. no.	CSS	plug	TL	c	B	kg/100	PU
280101	0,5 - 1,0	6,3x0,8	20,0	8,0	6,3	0,200	200
280105	1,0 - 2,5	6,3x0,8	20,0	8,0	6,3	0,085	200

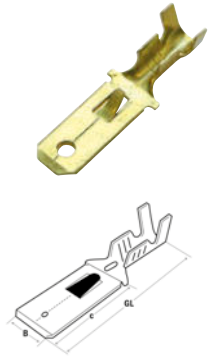

Socket sleeves (male) with latching tongue

- tin-plated brass
- uninsulated

Art. no.	CSS	plug	TL	c	B	kg/100	PU
280111	0,5 - 1,0	6,3x0,8	20,0	8,0	6,3	0,082	200
280115	1,0 - 2,5	6,3x0,8	20,0	8,0	6,3	0,089	200

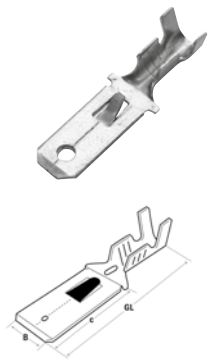

Ring terminals

- bare brass
- uninsulated

Art. no.	CSS	M	d2	TL	B	kg/100	PU
280120	0,5 - 1,0	3	3,2	21,0	8,0	0,054	200
280124		4	4,3	21,0	8,0	0,038	200
280128		5	5,08	22,0	9,5	0,068	200
280132	1,0 - 2,5	3	3,2	21,0	8,0	0,076	200
280136		4	4,3	21,0	8,0	0,046	200
280140		5	5,08	22,0	9,5	0,045	200

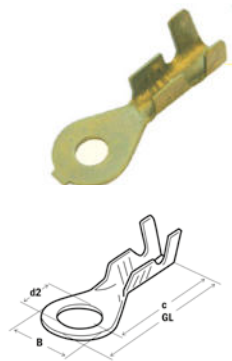

Ring terminals

- tin-plated brass
- uninsulated

Art. no.	CSS	M	d2	TL	B	kg/100	PU
280150	0,5 - 1,0	3	3,2	21,0	8,0	0,057	200
280154		4	4,3	21,0	8,0	0,040	200
280158		5	5,08	22,0	9,5	0,056	200
280162	1,0 - 2,5	3	3,2	21,0	8,0	0,076	200
280166		4	4,3	21,0	8,0	0,046	200
280170		5	5,08	22,0	9,5	0,043	200

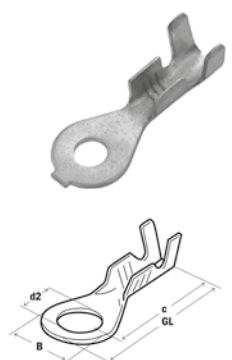

Flat terminals

- bare brass
- uninsulated

Art. no.	plug	d2	TL	form		kg/100	PU
280180	6,3x0,8	4,2	19,2	1	0°	0,076	200
280182	6,3x0,8	4,2	10,2	5	45°	0,082	200
280184	6,3x0,8	4,2	11,3	2	90°	0,085	200
280186	6,3x0,8	4,2	30,3	4	0°	0,136	200
280188	6,3x0,8	4,2	11,45	3	90°	0,134	200

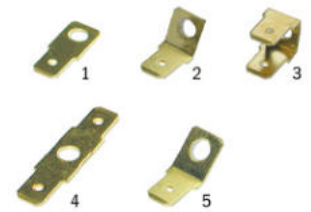

Flat terminals

- tin-plated brass
- uninsulated

Art. no.	plug	d2	TL	form		kg/100	PU
280190	6,3x0,8	4,2	19,2	1	0°	0,083	200
280192	6,3x0,8	4,2	10,2	5	45°	0,084	200
280194	6,3x0,8	4,2	11,3	2	90°	0,095	200
280196	6,3x0,8	4,2	30,3	4	0°	0,137	200
280198	6,3x0,8	4,2	11,45	3	90°	0,272	200

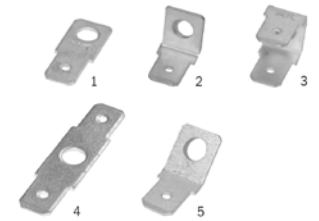

Insulating sleeves

- of PVC and nylon

Art. no.	plug	form	material	kg/100	PU
280200	6,3x0,8	1	PVC	0,056	100
280202	6,3x0,8	2	Nylon	0,069	100
280204	4,8x0,8	6	PVC	0,047	100
280206	4,8x0,8	2	Nylon	0,071	100
280208	2,8x0,8	6	PVC	0,036	100
280210	2,8x0,8	5	Nylon	0,043	100
280212	6,3x0,8	4	PVC	0,063	100
280214	6,3x0,8	3	Nylon	0,048	100



Elastic connectors with socket sleeves (male)

- 1 - 12 pole
- PVC, natural colour

Art. no.	plug	TL	form	B	material	kg/100	PU
280460	2,8x0,8	7,5	1	35,0	PVC	0,157	100
280482	2,8x0,8	88,0	12	35,0	PVC	1,770	10
280490	4,8x0,8	12,5	1	28,0	PVC	0,200	100
280512	4,8x0,8	147,0	12	28,0	PVC	2,800	10
280520	6,3x0,8	12,5	1	28,0	PVC	0,240	100
280542	6,3x0,8	147,0	12	28,0	PVC	2,850	10
280550	2,8x0,8	12,5	1	28,0	PVC	0,250	100
280572	2,8x0,8	147,0	12	28,0	PVC	0,440	50

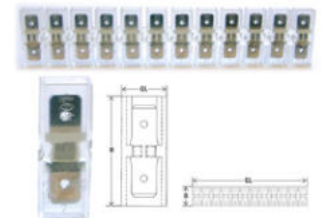

Elastic cable distributors

- PVC, natural colour

Art. no.	plug	TL	form	c	material	kg/100	PU
280580	6,3x0,8	53,0	1	15,0	PVC	0,500	50
280582	6,3x0,8	51,0	2	13,0	PVC	0,500	50

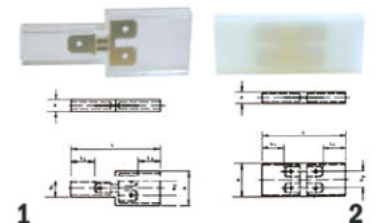

Socket sleeves (female) „SmallPack“

- bare brass
- not insulated

Art. no.	CSS	plug	TL	c	B	kg/100	PU
280000/20	0,5 - 1	6,3x0,8	19,2	7,6	7,6	0,070	20
280004/20	1 - 2,5	6,3x0,8	19,2	7,6	7,6	0,070	20
280008/20	0,5 - 1,25	4,8x0,8	15,0	6,4	5,6	0,070	20



Socket sleeves (female) „SmallPack“ with branch

- bare brass
- not insulated

Art. no.	CSS	plug	TL	c	B	kg/100	PU
280084/20	1,0 - 2,5	6,3x0,8	15,0	6,4	5,6	0,070	20



Flat terminals „SmallPack“

- bare brass
- not insulated

Art. no.	CSS	plug	TL	c	B	kg/100	PU
280100/20	0,5 - 1	6,3x0,8	20,6	6,35	6,3	0,070	20
280104/20	1 - 2,5	6,3x0,8	17,2	6,35	6,3	0,070	20



Cable lugs and connectors



1. The choice of the connector

In order to obtain a connection that can be guaranteed for a long time it is necessary to select the connectors suitable to the application field and strictly conform to the section of the cable to be crimped. In the large range of Haupa products you will certainly find the ideal solution for every requirement.

2. Stripping

Every crimping operation requires first that the cable is stripped without deforming the wires (+10% - since length expansion of crimp sleeve).

3. Cleaning

The conductor ends have to be solidly cleaned from oxidation and every rest of dirt before mounting.

4. Assembling

- Fit the connector to the cable with a round section in the complete length of the stripped area.
- Verify that there are no wires outside the connector. If you need to use sectoral cables you must arrange a previous rounding crimping operation of the cable.

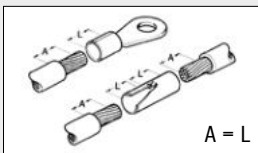

5. Choice of the crimping tool

All dies and punchings of the Haupa crimp system guarantee a high degree of connection between connector and cable. Exercise the crimping operation as shown in drawing 1 on the terminals and as drawing 2 on the butt connectors. The elevated pressure exerted by dies on terminals cause a uniform deformation on the whole crimping area.

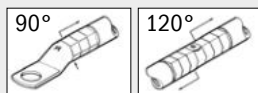

6. Caution

For aluminium cables shoes and connectors, excess, escaped pressing additives must be wiped away.

7. Tensile strength

When correctly processed in accordance with the HAUPA pressing instructions and using HAUPA pressing tools, a tensile strength is ensured in accordance with DIN EN61238-1.

Pressing number for HAUPA conduit terminals and connectors

conductor cross section CSS	HAUPA standard tubular cable lugs "commonly-available version" VDE 0295 class 2		HAUPA F-Type tubular cable lugs Cable class 5 / 6
	quantity crimpings slim 5 mm	quantity crimpings wide > 8 mm	quantity crimpings
0,75	1	-	-
1,5	1	-	-
2,5	1	-	-
4	1	-	-
6	1	-	-
10	1	1	-
16	1	1	1
25	2	1	1
35	2	1	1
50	2	1	1
70	2	1	1
95	2	1	1
120	2	1	1
150	2	1	2
185	2	1*	2
240	4	2	2
300	4	2	2
400	4	2	-
500	4	2	-
625	4	2	-

* when using the four thorn pressing, number of pressings:
AD300-6, SD300-6, HD300-6, KD300-6 /
AD400-6, SD400-6, HD400-6, HKD400
(page 75 - 76)

Temperature resistance

Connector	Temperature
Cable lugs & connectors copper	max.120° C (in acc. to DIN 46234)
Cable lugs & connectors aluminium	max.120° C (in acc. to IEC 61238)
Cable lugs & connectors of pure nickel	max. 500° C
End sleeves without insulation	max. 120° C (in acc. to DIN 46234)
End sleeves insulated	max. 105° C
Insulated terminals PVC	- 10° C --> + 75° C
Insulated terminals Nylon	- 55° C --> + 105° C
Insulated terminals PC	- 40° C --> + 125° C
Shrinking terminals	- 55° C --> + 105° C
Socket sleeves male & female, tin-coated brass, uninsulated	- 55° C --> + 100° C

HAUPA cable connections with insulated cables, maximum power loads

Core cross-section mm ²	Duct-laid single core cables		Multi-core cables		Exposed air laid single core (gap corresponds to diameter at the least)
	AL	CU	AL	CU	AL
(A)	(A)	(A)	(A)	(A)	(A)
0,75	-	-	12	-	15
1	11	-	15	-	19
1,5	15	-	15	-	19
2,5	20	-	26	-	32
4	25	-	34	-	42
6	33	-	44	-	54
10	45	-	61	48	73
16	61	48	82	64	98
25	83	65	108	85	129
35	103	81	135	105	158
50	132	103	168	132	198
70	165	-	207	163	245
95	197	-	250	197	292
120	235	-	292	230	344
150	-	-	335	263	391
185	-	-	383	301	448
240	-	-	453	357	528
300	-	-	504	409	608
400	-	-	-	-	726
500	-	-	-	-	830

Valid at ambient temperatures of 30 degrees Celsius

Crimp ring terminals without insulation DIN 46234

- Material: 99,9% electrolytic copper • Surface: tin-plated
- Ring type • For conductors, e.g. to VDE 0295 class 2,5,6
- Hard soldered in crimping area
- Grooved profile for improved contact characteristics

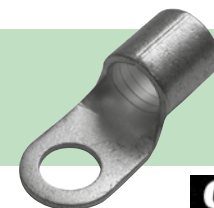

Cu

Art. no.	CSS	M	d2	d1	A	TL	B	kg/100	PU
290619	0,5 - 1,0	2,5	2,6	1,95	5,2	17,25	8,0	0,056	100
290620 *		3	3,2	1,95	5,2	17,25	8,0	0,055	100
290621		3,5	3,7	1,95	5,2	17,25	8,0	0,039	100
290622		4	4,2	1,95	5,2	16,65	8,0	0,065	100
290624		5	5,2	1,95	5,2	17,25	8,0	0,082	100
290623 *		6	6,2	1,95	5,2	18,5	10,0	0,091	100
290625		8	8,2	1,95	5,2	25,0	14,0	0,121	100
290617		10	10,5	1,95	5,2	25,0	14,0	0,178	100
290626	1,5 - 2,5	3	3,2	2,45	5,2	17,25	8,0	0,065	100
290627		3,5	3,7	2,45	5,2	17,25	8,0	0,058	100
290628		4	4,2	2,45	5,2	17,25	8,0	0,076	100
290630 *		5	5,2	2,45	5,2	20,0	10,0	0,097	100
290632 *		6	6,2	2,45	5,2	22,0	11,0	0,110	100
290634		8	8,2	2,45	5,2	26,8	15,0	0,132	100
290635		10	10,5	2,45	5,2	26,8	15,0	0,138	100
290636	4,0 - 6,0	4	4,2	3,5	6,5	18,7	8,0	0,131	100
290637		3,5	3,7	3,5	6,5	18,7	8,0	0,058	100
290646 *		5	5,3	3,6	6,0	15,0	10,0	0,157	100
290648 *		6	6,5	3,6	6,0	16,0	11,0	0,166	100
290650		8	8,4	3,6	6,0	19,0	14,0	0,214	100
290652		10	10,5	3,6	6,0	21,0	18,0	0,281	100
290654		12	13,0	3,6	6,0	21,0	18,0	0,219	100
290656	10	5	5,3	4,5	8,0	16,0	10,0	0,216	100
290658 *		6	6,4	4,5	8,0	17,0	11,0	0,227	100
290660		8	8,4	4,5	8,0	20,0	14,0	0,280	100
290662		10	10,5	4,5	8,0	21,0	18,0	0,339	100
290663		12	13,0	4,5	8,0	23,0	22,0	0,300	100
290664	16	5	5,3	5,8	10,0	20,0	10,0	0,353	100
290666		6	6,4	5,8	10,0	20,0	11,0	0,362	100
290668 *		8	8,4	5,8	10,0	22,0	14,0	0,404	100
290670		10	10,5	5,8	10,0	24,0	18,0	0,477	100
290672		12	13,0	5,8	10,0	26,0	22,0	0,565	100
290676	25	6	6,4	7,5	11,0	25,0	12,0	0,706	50
290678 *		8	8,4	7,5	11,0	25,0	16,0	0,776	50
290680		10	10,5	7,5	11,0	26,0	18,0	0,764	50
290682		12	13,0	7,5	11,0	31,0	22,0	0,886	50
290684		16	17,0	7,5	11,0	35,0	28,0	1,190	50
290686 *	35	8	8,4	9,0	12,0	26,0	16,0	0,896	50
290688		10	10,5	9,0	12,0	27,0	18,0	0,900	50
290690		12	13,0	9,0	12,0	31,0	22,0	1,000	50
290692		16	17,0	9,0	12,0	36,0	28,0	1,400	50
290694	50	8	8,4	11,0	16,0	34,0	18,0	1,600	40
290696 *		10	10,5	11,0	16,0	34,0	18,0	1,600	40
290698		12	13,0	11,0	16,0	36,0	22,0	1,700	40
290700		16	17,0	11,0	16,0	40,0	28,0	2,000	25
290701	70	8	8,4	13,0	18,0	38,0	22,0	2,500	25
290702 *		10	10,5	13,0	18,0	38,0	22,0	2,500	25
290704		12	13,0	13,0	18,0	38,0	22,0	2,400	20
290707	95	8	8,4	15,0	20,0	42,0	24,0	3,800	20
290708 *		10	10,5	15,0	20,0	42,0	24,0	3,800	20
290710 *		12	13,0	15,0	20,0	42,0	24,0	3,700	20
290712		16	17,0	15,0	20,0	44,0	28,0	3,900	20
290713 *	120	10	10,5	16,5	22,0	44,0	24,0	5,200	25
290714 *		12	13,0	16,5	22,0	44,0	24,0	5,200	25
290716		16	17,0	16,5	22,0	48,0	28,0	6,200	25
290717		20	21,0	16,5	22,0	53,0	32,0	5,900	25
290719	150	10	10,5	19,0	24,0	50,0	30,0	7,500	25
290721 *		12	13,0	19,0	24,0	50,0	30,0	7,400	25
290718		16	17,0	19,0	24,0	50,0	30,0	6,800	25
290720 *	185	16	17,0	21,0	25,0	50,0	36,0	9,400	20

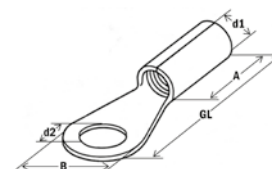

Insulated crimp cable lugs

- Nylon-insulated • Material: 99,9% E-Cu • Surface: tin-plated
- Ring type • For conductors, e.g. to VDE 0295 class 2, 5, 6
- Hard soldered in crimping area • Grooved profile for improved contact characteristics
- Crimp direct with insulation



Art. no.	CSS	M	d2	d1	d4	A	TL	kg/100	PU
260902	10	5	5,3	4,5	8,0	16,5	24,5	0,283	100
260904 *		6	6,5	4,5	8,0	16,5	25,5	0,240	100
260906		8	8,4	4,5	8,0	16,5	28,5	0,200	100
260908		10	10,5	4,5	8,0	16,5	29,5	0,400	100
260910		12	13,0	4,5	8,0	16,5	31,5	0,420	100
260912	16	5	5,3	5,8	11,0	21,5	31,5	0,400	100
260914		6	6,5	5,8	11,0	21,5	31,5	0,400	100
260916 *		8	8,4	5,8	11,0	21,5	33,5	0,500	100
260918		10	10,5	5,8	11,0	21,5	35,5	0,600	100
260920		12	13,0	5,8	11,0	21,5	37,5	0,600	100
260922	25	5	5,3	7,5	13,0	24,0	38,0	0,800	100
260924		6	6,5	7,5	13,0	24,0	38,0	0,800	100
260926 *		8	8,4	7,5	13,0	24,0	38,0	0,900	100
260928		10	10,5	7,5	13,0	24,0	39,0	1,000	100
260930		12	13,0	7,5	13,0	24,0	44,0	1,100	100
260932		16	17,0	7,5	13,0	24,0	48,0	1,300	100
260934	35	6	6,5	9,0	14,5	27,0	41,0	1,100	100
260936 *		8	8,4	9,0	14,5	27,0	41,0	1,000	100
260938		10	10,5	9,0	14,0	27,0	42,0	1,000	100
260940		12	13,0	9,0	14,5	27,0	46,0	1,260	100
260942		16	17,0	9,0	14,5	27,0	51,0	1,550	100
260944	50	6	6,5	11,0	16,5	29,5	47,5	3,300	50
260946 *		8	8,4	11,0	16,5	29,5	47,5	3,300	50
260948		10	10,5	11,0	16,5	29,5	47,5	3,200	50
260950		12	13,0	11,0	16,5	29,5	49,5	3,600	50
260952		16	17,0	11,0	16,5	29,5	53,5	4,200	50
260954	70	6	6,5	13,0	18,7	31,5	51,0	5,200	50
260956		8	8,4	13,0	18,7	31,5	51,0	5,000	50
260960		12	13,0	13,0	18,7	31,5	51,0	5,000	50
260962		16	17,0	13,0	18,7	31,5	55,0	5,400	50
260964 *	95	8	8,4	15,0	21,7	35,5	57,5	8,000	50
260966		10	10,5	15,0	21,7	35,5	57,5	8,200	50
260968		12	13,0	15,0	21,7	35,5	57,5	7,800	50
260970		16	17,0	15,0	21,7	35,5	59,5	8,200	50
260972	120	8	8,4	16,5	24,2	40,0	62,0	10,600	25
260974 *		10	10,5	16,5	24,2	40,0	62,0	11,200	25
260976		12	13,0	16,5	24,2	40,0	62,0	10,800	25
260978		16	17,0	16,5	24,2	40,0	66,0	11,600	25
260980	150	10	10,5	19,0	27,2	44,0	70,0	16,800	25
260982		12	13,0	19,0	27,2	44,0	70,0	16,800	25
260984		16	17,0	19,0	27,2	44,0	70,0	16,800	25

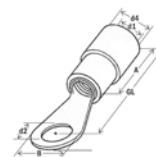

Solderless terminals for meter connection

- Nylon-insulated • Material: 99,9% E-Cu • Surface: tin-plated
- Fork type • For conductors, e.g. to VDE 0295 class 2, 5, 6
- Hard soldered in crimping area • Grooved profile for improved contact characteristics
- Crimp direct with insulation



Art. no.	CSS	M	kg/100	PU
260858	10	5	0,302	100
260860 *		6	0,320	100
260862	16	5	0,584	100
260863 *		8	0,630	100

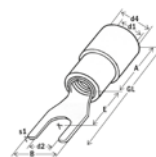

Fork terminals without insulation

- Material: 99,9% E-Cu • Surface: tin-plated
- Fork type • For conductors, e.g. to VDE 0295 class 2, 5, 6
- Hard soldered in crimping area
- Grooved profile for improved contact characteristics



Cu

Art. no.	CSS	M	d2	d1	A	TL	B	kg/100	PU
290730 *	0,5 - 1,0	3	3,2	1,95	5,2	14,6	5,6	0,076	100
290731		3,5	3,7	1,95	5,2	14,9	6,5	0,077	100
290732		4	4,2	1,95	5,2	15,0	6,4	0,058	100
290734		5	5,2	1,95	5,2	16,25	8,0	0,086	100
290735		6	6,2	1,95	5,2	17,5	9,2	0,087	100
290736	1,5 - 2,5	3	3,2	2,45	5,2	17,25	5,6	0,088	100
290739		3,5	3,7	2,45	5,2	14,3	6,6	0,083	100
290738 *		4	4,2	2,45	5,2	14,3	6,6	0,082	100
290740		5	5,2	2,45	5,2	19,25	9,1	0,095	100
290742		6	6,2	2,45	5,2	21,0	10,0	0,120	100
290744	4,0 - 6,0	4	4,2	3,5	6,5	18,6	8,0	0,152	100
290746		5	5,2	3,5	6,5	21,1	9,0	0,176	100
290748 *		6	6,2	3,5	6,5	22,3	11,0	0,161	100
290750		8	8,2	3,5	6,5	27,3	15,2	0,252	100
290751		10	10,5	3,5	6,5	30,2	19,0	0,319	100
290752	10	5	5,2	4,7	8,5	20,8	9,0	0,248	100
290754 *		6	6,4	4,7	8,5	20,8	10,3	0,260	100
290756 *	16	6	6,4	5,8	10,5	25,5	11,0	0,513	100

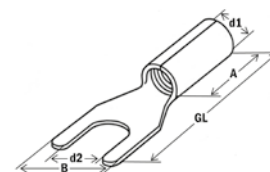

Pin terminals without insulation DIN 46230

- Material: 99,9% E-Cu • Surface: tin-plated
- Pin type • For conductors, e.g. to VDE 0295 class 2, 5, 6
- Hard soldered in crimping area
- Grooved profile for improved contact characteristics



Cu

Art. no.	CSS	d1	A	TL	E	B	kg/100	PU
290770 *	0,5 - 1,0	1,85	5,0	17,3	12,0	1,8	0,083	100
290771		1,85	5,0	17,3	9,0	1,8	0,078	100
290773 *	1,5 - 2,5	2,4	5,0	17,3	12,0	1,8	0,065	100
290775		2,4	5,0	17,3	9,0	1,8	0,058	100
290777	4,0 - 6,0	3,6	6,0	24,5	12,5	2,6	0,157	100
290776	10	4,5	8,5	20,5	14,0	4,0	0,300	100
290778 *	16	5,8	10,5	26,5	14,0	4,5	0,411	100
290780 *	25	7,0	14,0	33,0	15,0	7,0	0,600	100
290782	35	8,2	16,0	40,0	20,0	8,0	1,238	100
290784	50	9,5	19,0	45,0	20,0	9,5	1,800	100
290786	70	11,2	24,0	55,0	25,0	11,5	3,053	50
290788	95	13,59	24,0	55,0	25,0	13,5	4,100	50

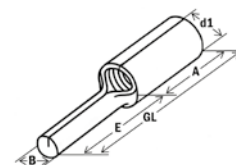

Solderless connectors

Parallel connectors DIN 46341 part 1, type A

- Material: 99,9% electrolytic copper • Surface: tin-plated
- For connecting different conductor cross-sections
- Hard soldered in crimping area
- Grooved profile for improved contact characteristics

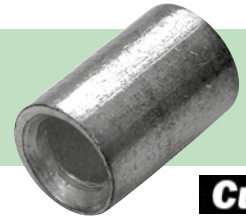

Cu

Art. no.	CSS	d1	d4	TL	kg/100		PU
291090 *	0,5 - 1,0	1,6	3,3	7	0,064	2000	100
291092	1,5 - 2,5	2,3	4,2	7	0,070	2000	100
291096	4 - 6	3,6	5,5	7	0,090	1800	100
291098 *	10	4,5	7,0	9	0,165	2000	100
291100	16	5,5	8,5	10	0,274	1000	100
291102	25	7,0	10,0	13	0,500	600	100
291104	35	8,5	12,0	16	0,800	300	50
291106	50	10,0	14,0	19	1,200	300	50
291108	70	12,0	16,5	19	1,600	200	50
291110	95	13,5	18,0	20	2,400	150	25
291112	120	15,0	19,5	22	3,500	100	25
291114	150	16,5	21,0	26	3,000	80	20

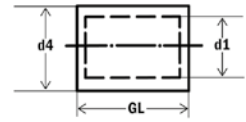

Solderless butt connectors DIN 46341 part 1, type B

- Material: 99.9% electrolytic copper
- Surface: tin-plated • annealing for easier crimping
- For stranded conductors e.g. VDE 0295 class 2, 5, 6
- With buttmarks for precise cable insertion



Cu

Art. no.	CSS	d1	d4	TL	kg/100		PU
291119 *	0,5 - 1,0	1,6	3,3	15	0,200	2000	100
291120 *	1,5 - 2,5	2,3	4,2	15	0,127	2000	100
291124 *	4 - 6	3,6	5,5	15	0,200	2000	100
291126 *	10	4,5	7,0	21	0,300	800	100
291128 *	16	5,5	8,5	26	0,600	500	50
291130	25	7,0	10,0	29	1,100	400	50
291132	35	8,5	12,0	32	1,500	150	25
291134	50	10,0	14,0	48	2,300	150	25
291136	70	12,0	16,5	48	3,400	100	25
291138	95	13,5	18,0	48	5,800	50	25
291140	120	15,0	19,5	48	8,500	50	25
291142	150	16,5	21,0	48	11,100	40	20

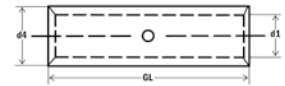

Tubular terminals, Light "T" series

light



- Material: 99.9% electrolytic copper E-CU DIN 40500
- Surface: tin-plated
- with sight hole

Art. no.	CSS	M	d2	d1	d4	A	TL	kg/100	PU
294000	1,5	4	4,3	2,4	4,0	7,0	19,0	0,105	2000 100
294002 *		5	5,3	2,4	4,0	7,0	19,0	0,101	2000 100
294004		6	6,4	2,4	4,0	7,0	20,0	0,101	2000 100
294006	2,5	4	4,3	2,7	4,3	7,0	19,0	0,117	2000 100
294008 *		5	5,3	2,7	4,3	7,0	19,0	0,113	2000 100
294010		6	6,4	2,7	4,3	7,0	21,0	0,119	2000 100
294012		8	8,3	2,7	4,3	7,0	23,0	0,121	2000 100
294014	4	4	4,3	3,1	4,8	9,5	21,5	0,162	2000 100
294016 *		5	5,3	3,1	4,8	9,5	21,5	0,152	2000 100
294018		6	6,4	3,1	4,8	9,5	23,5	0,100	2000 100
294020		8	8,3	3,1	4,8	9,5	28,5	0,200	2000 100
294022	6	4	4,3	3,8	5,5	10,0	26,0	0,200	1800 100
294024 *		5	5,3	3,8	5,5	10,0	26,0	0,200	1800 100
294026 *		6	6,4	3,8	5,5	10,0	26,0	0,300	1400 100
294028		8	8,3	3,8	5,5	10,0	29,0	0,200	1400 100
294034	10	5	5,3	4,7	6,9	11,5	27,5	0,300	1000 100
294036 *		6	6,4	4,7	6,9	11,5	27,5	0,300	1000 100
294038 *		8	8,3	4,7	6,9	11,5	30,5	0,300	800 100
294040		10	10,5	4,7	6,9	11,5	30,5	0,300	600 100
294044	16	5	5,3	5,6	7,8	12,0	27,5	0,400	600 100
294046		6	6,4	5,6	7,8	12,0	27,5	0,400	600 100
294048 *		8	8,3	5,6	7,8	12,0	31,0	0,500	400 100
294050		10	10,5	5,6	7,8	12,0	32,0	0,400	400 100
294052		12	13,2	5,6	7,8	12,0	37,5	0,500	400 100
294054	25	6	6,4	7,1	9,5	13,5	34,0	0,700	400 50
294056 *		8	8,3	7,1	9,5	13,5	34,0	0,700	400 50
294058		10	10,5	7,1	9,5	13,5	37,0	0,700	300 50
294060 *		12	13,2	7,1	9,5	13,5	40,0	0,800	300 50
294062	35	6	6,4	8,2	11,0	16,0	39,0	1,300	240 50
294064 *		8	8,3	8,2	11,0	16,0	39,0	2,900	240 50
294066		10	10,5	8,2	11,0	16,0	43,0	1,300	160 50
294068		12	13,2	8,2	11,0	16,0	43,0	1,200	160 50
294070		14	14,5	8,2	11,0	16,0	48,0	1,300	160 50
294080	50	6	6,4	9,5	12,5	20,0	45,0	1,700	150 40
294082		8	8,3	9,5	12,5	20,0	45,0	1,700	150 40
294084 *		10	10,5	9,5	12,5	20,0	49,0	1,900	150 40
294086		12	13,2	9,5	12,5	20,0	49,0	1,800	100 40
294088		14	14,5	9,5	12,5	20,0	54,0	1,900	100 30
294094	70	8	8,3	11,5	15,0	20,0	47,6	2,700	100 25
294096 *		10	10,5	11,5	15,0	20,0	51,6	2,800	100 25
294098		12	13,2	11,5	15,0	20,0	51,6	2,600	100 25
294100		14	14,5	11,5	15,0	20,0	62,6	3,300	80 20
294102		16	16,5	11,5	15,0	20,0	62,6	3,100	80 20
294106	95	8	8,3	13,5	17,0	22,0	55,8	3,500	80 20
294108		10	10,5	13,5	17,0	22,0	55,8	3,500	80 20
294110 *		12	13,2	13,5	17,0	22,0	55,8	2,900	80 20
294112		14	14,5	13,5	17,0	22,0	66,8	4,000	60 15
294114		16	16,5	13,5	17,0	22,0	66,8	3,900	60 15
294118	120	10	10,5	15,6	20,0	27,0	71,5	6,900	80 10
294120 *		12	13,2	15,6	20,0	27,0	71,5	6,800	80 10
294122		14	14,5	15,6	20,0	27,0	71,5	6,600	40 10
294124		16	16,5	15,6	20,0	27,0	71,5	6,400	40 10
294128	150	10	10,5	16,5	21,0	32,0	78,0	8,000	40 10
294130 *		12	13,2	16,5	21,0	32,0	78,0	8,000	40 10
294132		14	14,5	16,5	21,0	32,0	78,0	7,800	40 10
294134		16	16,5	16,5	21,0	32,0	78,0	7,500	40 10
294138	185	10	10,5	18,4	23,6	34,0	84,0	11,200	40 10
294140		12	13,2	18,4	23,6	34,0	84,0	11,200	40 20
294142		14	14,5	18,4	23,6	34,0	84,0	10,800	40 20
294144		16	16,5	8,4	23,6	34,0	84,0	10,800	40 20

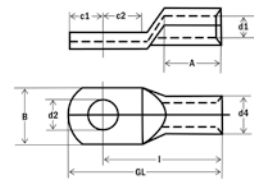

Tubular terminals, Light "T" series

light

- tubular
- Material: 99.9% electrolytic copper E-CU DIN 40500
- Surface: tin-plated
- with sight hole



Cu

Art. no.	CSS	M	d2	d1	d4	A	TL	kg/100		PU
294150	240	12	13,2	21,2	26,4	37,0	90,0	13,300	20	10
294152		14	14,5	21,2	26,4	37,0	90,0	13,000	20	10
294154 *		16	16,5	21,2	26,4	37,0	90,0	15,000	20	10
294160	300	12	13,2	23,4	28,6	40,0	96,0	15,400	16	8
294162		14	14,5	23,4	28,6	40,0	96,0	15,000	16	8
294164		16	16,5	23,4	28,6	40,0	96,0	2,900	16	8
294174	400	16	16,5	26,8	32,8	37,0	104,7	22,700	10	5
294176		20	21,0	26,8	32,8	37,0	104,7	22,000	10	5
294184	500	16	16,5	29,8	38,4	46,5	115,5	42,000	8	3
294196	630	20	21,0	34,5	44,7	50,0	133,0	66,800	6	3

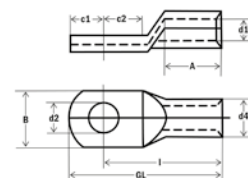

Butt connectors, Light "M" series

light

- Material: 99.9% electrolytic copper E-CU DIN 40500
- Surface: tin-plated • annealing for easier crimping
- for stranded conductors e.g. VDE 0295 class 2
- with buttmarks for precise cable insertion



Cu

Art. no.	CSS	d1	d4	TL	kg/100		PU
294200	1,5	2,4	4,0	22,0	0,080	2000	200
294202	2,5	2,7	4,3	22,0	0,080	2000	200
294204	4	3,1	4,8	25,0	0,300	1000	100
294206	6	3,8	5,5	25,0	0,300	1000	100
294208	10	4,7	6,9	25,0	0,400	600	100
294210	16	5,6	7,8	29,0	0,500	600	100
294212	25	7,1	9,5	29,0	0,700	500	50
294214	35	8,2	11,0	35,0	1,200	300	50
294218	50	9,5	12,5	35,0	1,400	240	40
294220	70	11,5	15,0	45,0	2,700	120	20
294222	95	13,5	17,0	47,0	3,200	40	20
294224	120	15,6	20,0	52,0	5,500	40	20
294226	150	16,5	21,0	59,0	6,500	40	20
294228	185	18,4	23,6	65,0	9,200	40	20
294230	240	21,2	26,4	75,0	11,900	20	10
294232	300	23,4	28,6	90,0	14,500	10	5
294234	400	26,8	32,8	106,0	24,200	10	5



Tubular cable lugs, standard series

HUPtype



Cu

- For stranded round shaped conductors e.g. VDE 0295 class 2
- For preround sector shaped conductors • Annealed material for easier crimping
- Material: 99.9% electrolytic copper E-CU DIN 40500 • Surface: tin-plated
- Vibration and shock proofing DIN EN 61373:1999-11, Cat. 1, Cl. B

available with and without sight hole e.g. 29 09 00/S (add xx xx xx/s when ordering)

Art. no.	CSS	M	d2	d1	d4	A	v1	v2	l	B	c1	c2	kg/100	PU	PU
290900 *	0,75	3	3,2	1,3	2,8	6,0	1	-	12,0	6,0	3,25	4,0	0,073	2000	100
290902		4	4,3	1,3	2,8	6,0	1	-	13,0	6,5	4,0	5,0	0,064	2000	100
290904	1,5	3	3,2	1,8	3,3	6,0	1	-	12,0	6,5	3,25	4,0	0,060	2000	100
290906 *		4	4,3	1,8	3,3	6,0	1	-	13,0	6,5	4,0	5,0	0,066	2000	100
290908 *		5	5,3	1,8	3,3	6,0	1	-	14,0	7,5	4,75	5,5	0,087	2000	100
290910		6	6,5	1,8	3,3	6,0	1	-	16,0	9,0	6,5	6,5	0,097	2000	100
290912	2,5	3	3,2	2,3	4,2	6,0	1	-	12,0	7,5	3,25	4,0	0,103	2000	100
290914		4	4,3	2,3	4,2	6,0	1	-	13,0	7,5	4,0	5,0	0,112	2000	100
290916 *		5	5,3	2,3	4,2	6,0	1	-	14,0	8,5	4,75	5,5	0,121	2000	100
290918		6	6,5	2,3	4,2	6,0	1	-	16,0	9,5	6,5	6,5	0,143	2000	100
290920		8	8,5	2,3	4,2	6,0	1	-	20,0	13,0	7,75	9,5	0,151	2000	100
290922	4	4	4,3	3,0	5,0	8,0	1	-	17,0	8,5	4,75	5,5	0,200	2000	100
290924 *		5	5,3	3,0	5,0	8,0	1	-	17,0	9,0	4,75	6,0	0,161	2000	100
290926 *		6	6,5	3,0	5,0	8,0	1	-	19,0	10,0	6,5	6,5	0,220	2000	100
290928		8	8,5	3,0	5,0	8,0	1	-	22,0	13,0	8,5	9,5	0,300	2000	100
290930	6	4	4,3	3,5	6,5	9,0	1	-	18,0	8,5	5,0	5,5	0,452	1800	100
290932 *		5	5,3	3,5	6,5	9,0	1	-	21,0	10,0	6,5	7,5	0,475	1800	100
290934 *		6	6,5	3,5	6,5	9,0	1	-	21,0	12,0	6,5	7,5	0,400	1400	100
290936		8	8,5	3,5	6,5	9,0	1	-	23,0	15,0	10,0	10,0	0,500	1400	100
290938	10	5	5,3	4,5	7,0	10,0	1	-	22,0	12,0	6,5	7,5	0,400	1000	100
290940 *		6	6,5	4,5	7,0	10,0	1	-	22,0	12,0	6,5	7,5	0,400	1000	100
290942 *		8	8,5	4,5	7,0	10,0	1	-	25,0	15,0	10,0	10,0	0,540	800	100
290944		10	10,5	4,5	7,0	10,0	1	-	27,0	17,0	12,0	12,0	0,573	600	100
290946		12	13,0	4,5	7,0	10,0	1	-	29,0	19,0	13,0	13,0	0,600	600	100
290948	16	5	5,3	5,5	8,5	13,0	1	1	26,0	12,0	5,5	6,5	0,800	600	100
290950		6	6,5	5,5	8,5	13,0	1	1	27,0	12,0	6,25	7,5	0,700	600	100
290952 *		8	8,5	5,5	8,5	13,0	1	1	29,0	15,0	8,5	9,5	0,800	400	100
290954		10	10,5	5,5	8,5	13,0	1	1	31,0	17,0	10,5	11,5	0,950	400	100
290956		12	13,0	5,5	8,5	13,0	1	1	33,0	19,0	12,0	13,0	1,000	400	100
290958	25	6	6,5	7,0	10,0	15,0	2	1	30,0	14,0	7,5	7,5	1,100	400	50
290960 *		8	8,5	7,0	10,0	15,0	2	1	32,0	16,0	10,0	10,0	1,200	400	50
290962		10	10,5	7,0	10,0	15,0	2	1	34,0	18,0	12,0	12,0	1,200	300	50
290964		12	13,0	7,0	10,0	15,0	2	1	35,0	19,0	13,0	13,0	1,300	300	50
290966	35	6	6,5	8,5	12,0	17,0	2	1	32,0	17,0	7,5	7,5	1,900	240	40
290968 *		8	8,5	8,5	12,0	17,0	2	1	34,0	17,0	10,0	10,0	1,900	240	40
290970		10	10,5	8,5	12,0	17,0	2	1	37,0	19,0	12,0	12,0	2,100	160	40
290972		12	13,0	8,5	12,0	17,0	2	1	38,0	21,0	13,0	13,0	2,000	160	40
290974		16	17,0	8,5	12,0	17,0	2	1	42,0	26,0	16,0	16,0	2,100	160	40
290976	50	6	6,5	10,0	14,0	19,0	2	1	37,0	20,0	10,0	10,0	2,900	160	40
290978 *		8	8,5	10,0	14,0	19,0	2	1	37,0	20,0	10,0	10,0	2,700	160	40
290980 *		10	10,5	10,0	14,0	19,0	2	1	39,0	20,0	12,0	12,0	2,900	160	25
290982		12	13,0	10,0	14,0	19,0	2	1	43,0	23,0	13,0	13,0	3,300	100	25
290984		16	17,0	10,0	14,0	19,0	2	1	46,0	28,0	16,0	16,0	3,100	100	25
290985	70	6	6,5	12,0	16,5	21,0	2	1	43,0	23,0	10,0	10,0	4,200	100	25
290986		8	8,5	12,0	16,5	21,0	2	1	43,0	23,0	10,0	10,0	4,200	100	25
290988 *		10	10,5	12,0	16,5	21,0	2	1	44,0	23,0	12,0	12,0	4,300	100	25
290990		12	13,0	12,0	16,5	21,0	2	1	46,0	23,0	13,0	13,0	4,500	100	25
290991		14	15,0	12,0	16,5	21,0	2	1	48,0	23,0	14,5	14,5	4,600	100	25
290992		16	17,0	12,0	16,5	21,0	2	1	50,0	28,0	16,0	16,0	5,100	100	25
290994	95	8	8,5	13,5	18,0	25,0	2	1	48,0	26,0	12,0	12,0	5,300	100	25
290996		10	10,5	13,5	18,0	25,0	2	1	48,0	26,0	12,0	12,0	5,100	100	25
290998 *		12	13,0	13,5	18,0	25,0	2	1	49,0	26,0	13,0	13,0	5,200	100	25
290999		14	15,0	13,5	18,0	25,0	2	1	51,0	26,0	14,5	14,5	5,400	60	15
291000		16	17,0	13,5	18,0	25,0	2	1	54,0	28,0	16,0	16,0	5,600	60	15
291002		20	21,0	13,5	18,0	25,0	2	1	60,0	36,0	22,0	22,0	6,000	60	15

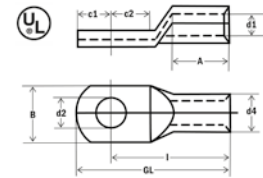

Brunel
access to excellence

Tubular terminals, standard series

HUPtype

- For stranded round shaped conductors e.g. VDE 0295 class 2
- For preround sector shaped conductors • Annealed material for easier crimping
- Material: 99.9% electrolytic copper E-CU DIN 40500 • Surface: tin-plated
- Vibration and shock proofing DIN EN 61373:1999-11, Cat. 1, Cl. B



Cu

available with and without sight hole e.g. 29 00 04/S (add xx xx xx/s when ordering)

Art. no.	CSS	M	d2	d1	d4	A	v1	v2	l	B	c1	c2	kg/100	PU	PU
290004	120	8	8,5	15,0	19,5	26,0	2	1	51,0	28,0	14,0	14,0	6,300	60	15
290006 *		10	10,5	15,0	19,5	26,0	2	1	51,0	28,0	14,0	14,0	6,200	60	15
290008 *		12	13,0	15,0	19,5	26,0	2	1	51,0	28,0	14,0	14,0	6,100	60	15
290009		14	15,0	15,0	19,5	26,0	2	1	52,0	28,0	15,0	15,0	5,900	72	18
290010		16	17,0	15,0	19,5	26,0	2	1	54,0	30,0	16,0	16,0	6,200	60	15
290012		20	21,0	15,0	19,5	26,0	2	1	63,0	36,0	22,0	22,0	7,900	60	15
290014	150	10	10,5	16,5	21,0	30,0	2	1	56,0	31,0	14,0	14,0	7,500	60	15
290016 *		12	13,0	16,5	21,0	30,0	2	1	57,0	31,0	15,0	15,0	7,300	60	15
290017		14	15,0	16,5	21,0	30,0	2	1	57,0	31,0	15,0	15,0	7,900	60	15
290018		16	17,0	16,5	21,0	30,0	2	1	58,0	31,0	16,0	16,0	7,500	60	15
290020		20	21,0	16,5	21,0	30,0	2	1	66,0	36,0	22,0	22,0	8,800	48	12
290022 *	185	12	13,0	19,0	24,0	30,0	2	1	65,0	35,0	18,0	18,0	11,100	40	20
290023		14	15,0	19,0	24,0	30,0	2	1	65,0	35,0	18,0	18,0	11,800	40	20
290024 *		16	17,0	19,0	24,0	30,0	2	1	65,0	35,0	18,0	18,0	10,700	40	20
290026		20	21,0	19,0	24,0	30,0	2	1	69,0	39,0	22,0	22,0	10,700	40	20
290028 *	240	12	13,0	21,0	26,0	35,0	4	2	72,0	39,0	21,5	19,0	13,700	30	15
290029		14	15,0	21,0	26,0	35,0	4	2	72,0	39,0	21,5	19,0	13,400	30	15
290030 *		16	17,0	21,0	26,0	35,0	4	2	72,0	39,0	21,5	19,0	13,400	30	15
290034	300	12	13,0	23,5	29,5	44,0	4	2	87,0	43,0	24,0	24,0	22,000	16	8
290036		14	15,0	23,5	29,5	44,0	4	2	87,0	43,0	24,0	24,0	21,700	16	8
290038		16	17,0	23,5	29,5	44,0	4	2	87,0	43,0	24,0	24,0	21,300	16	8
290040		20	21,0	23,5	29,5	44,0	4	2	87,0	43,0	24,0	24,0	21,400	16	8
290046	400	16	17,0	27,0	34,0	44,0	4	2	90,0	49,0	24,0	24,0	31,800	10	5
290048		20	21,0	27,0	34,0	44,0	4	2	90,0	49,0	24,0	24,0	30,500	10	5
290041	500	16	17,0	31,0	38,0	70,0	4	2	103,0	55,0	24,0	24,0	45,000	12	6
290043		20	21,0	31,0	38,0	70,0	4	2	103,0	55,0	24,0	24,0	45,000	12	6
290045	625	16	17,0	34,0	41,0	70,0	4	2	108,0	60,0	24,0	24,0	49,200	6	3
290047		20	21,0	34,0	41,0	70,0	4	2	108,0	60,0	24,0	24,0	49,200	6	3

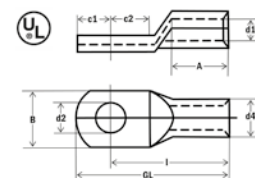

Brunel
access to excellence

Angled tubular cable lugs 90°, standard series

HUPtype

- For stranded round shaped conductors e.g. VDE 0295 class 2
- For preround sector shaped conductors • Annealed material for easier crimping
- Material: 99.9% electrolytic copper E-CU DIN 40500
- Surface: tin-plated



Cu

Art. no.	CSS	M	d2	d1	d4	A	v1	v2	l	B	c1	c2	kg/100	PU	PU
290932/90	6	5	5,3	3,5	6,5	9,0	1	-	21,0	10,0	6,5	7,5	0,475	1800	100
290934/90		6	6,5	3,5	6,5	9,0	1	-	21,0	12,0	6,5	7,5	0,400	1400	100
290936/90		8	8,5	3,5	6,5	9,0	1	-	23,0	15,0	10,0	10,0	0,500	1400	100
290938/90	10	5	5,3	4,5	7,0	10,0	1	-	22,0	12,0	6,5	7,5	0,400	1000	100
290940/90		6	6,5	4,5	7,0	10,0	1	-	22,0	12,0	6,5	7,5	0,400	1000	100
290942/90		8	8,5	4,5	7,0	10,0	1	-	25,0	15,0	10,0	10,0	0,540	800	100
290944/90		10	10,5	4,5	7,0	10,0	1	-	27,0	17,0	12,0	12,0	0,573	600	100
290948/90	16	5	5,3	5,5	8,5	13,0	1	1	26,0	12,0	5,5	6,5	0,800	600	100
290950/90		6	6,5	5,5	8,5	13,0	1	1	27,0	12,0	6,25	7,5	0,700	600	100
290952/90		8	8,5	5,5	8,5	13,0	1	1	29,0	15,0	8,5	9,5	0,800	400	100
290954/90		10	10,5	5,5	8,5	13,0	1	1	31,0	17,0	10,5	11,5	0,950	400	100
290956/90		12	13,0	5,5	8,5	13,0	1	1	33,0	19,0	12,0	13,0	1,000	400	100
290958/90	25	6	6,5	7,0	10,0	15,0	2	1	30,0	14,0	7,5	7,5	1,100	400	50
290960/90		8	8,5	7,0	10,0	15,0	2	1	32,0	16,0	10,0	10,0	1,200	400	50
290962/90		10	10,5	7,0	10,0	15,0	2	1	34,0	18,0	12,0	12,0	1,250	300	50
290964/90		12	13,0	7,0	10,0	15,0	2	1	35,0	19,0	13,0	13,0	1,300	300	50

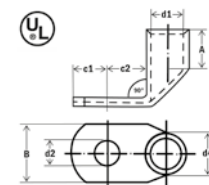

Angled tubular cable lugs 90°, standard series

HUPtype

- For stranded round shaped conductors e.g. VDE 0295 class 2
- For preround sector shaped conductors • Annealed material for easier crimping
- Material: 99.9% electrolytic copper E-CU DIN 40500
- Surface: tin-plated



Cu

Art. no.	CSS	M	d2	d1	d4	A	v1	v2	l	B	c1	c2	kg/100	PU	
290966/90	35	6	6,5	8,5	12,0	17,0	2	1	32,0	17,0	7,5	7,5	1,900	240	40
290968/90		8	8,5	8,5	12,0	17,0	2	1	34,0	17,0	10,0	10,0	1,900	240	40
290970/90		10	10,5	8,5	12,0	17,0	2	1	37,0	19,0	12,0	12,0	2,100	160	40
290972/90		12	13,0	8,5	12,0	17,0	2	1	38,0	21,0	13,0	13,0	2,000	160	40
290976/90	50	6	6,5	10,0	14,0	19,0	2	1	37,0	20,0	10,0	10,0	2,900	160	40
290978/90		8	8,5	10,0	14,0	19,0	2	1	37,0	20,0	10,0	10,0	2,700	160	40
290980/90		10	10,5	10,0	14,0	19,0	2	1	39,0	20,0	12,0	12,0	2,900	150	25
290982/90		12	13,0	10,0	14,0	19,0	2	1	43,0	23,0	13,0	13,0	3,300	100	25
290986/90	70	8	8,5	12,0	16,5	21,0	2	1	43,0	23,0	10,0	10,0	4,200	100	25
290988/90	*	10	10,5	12,0	16,5	21,0	2	1	44,0	23,0	12,0	12,0	4,300	100	25
290990/90		12	13,0	12,0	16,5	21,0	2	1	46,0	23,0	13,0	13,0	4,500	100	25
290992/90		16	17,0	12,0	16,5	21,0	2	1	50,0	28,0	16,0	16,0	5,100	100	25
290994/90	95	8	8,5	13,5	18,0	25,0	2	1	48,0	26,0	12,0	12,0	5,300	100	25
290996/90		10	10,5	13,5	18,0	25,0	2	1	48,0	26,0	12,0	12,0	5,100	100	25
290998/90		12	13,0	13,5	18,0	25,0	2	1	49,0	26,0	13,0	13,0	5,200	100	25
291000/90		16	17,0	13,5	18,0	25,0	2	1	54,0	28,0	16,0	16,0	5,600	60	15
291002/90		20	21,0	13,5	18,0	25,0	2	1	60,0	36,0	22,0	22,0	6,000	60	15
290006/90	120	10	10,5	15,0	19,5	26,0	2	1	51,0	28,0	14,0	14,0	6,200	60	15
290008/90		12	13,0	15,0	19,5	26,0	2	1	51,0	28,0	14,0	14,0	6,100	60	15
290010/90		16	17,0	15,0	19,5	26,0	2	1	54,0	30,0	16,0	16,0	6,200	60	15
290014/90	150	10	10,5	16,5	21,0	30,0	2	1	56,0	31,0	14,0	14,0	7,500	60	15
290016/90		12	13,0	16,5	21,0	30,0	2	1	57,0	31,0	15,0	15,0	7,300	60	15
290018/90		16	17,0	16,5	21,0	30,0	2	1	58,0	31,0	16,0	16,0	7,500	60	15
290020/90		20	21,0	16,5	21,0	30,0	2	1	66,0	36,0	22,0	22,0	8,800	60	12
291004/90	185	10	10,5	19,0	24,0	30,0	2	1	65,0	35,0	18,0	18,0	11,100	40	20
290022/90		12	13,0	19,0	24,0	30,0	2	1	65,0	35,0	18,0	18,0	11,100	40	20
290024/90		16	17,0	19,0	24,0	30,0	2	1	65,0	35,0	18,0	18,0	10,700	40	20
290028/90	240	12	13,0	21,0	26,0	35,0	4	2	72,0	39,0	21,5	19,0	13,700	30	15
290030/90		16	17,0	21,0	26,0	35,0	4	2	72,0	39,0	21,5	19,0	13,400	30	15

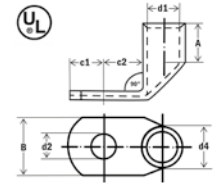

Butt connectors, standard series

HUPtype

- Material: 99.9% E-CU DIN 40500
- Surface: tin-plated • Annealed material for easier crimping
- For stranded conductors e.g. VDE 0295 class 2
- with buttmarks for precise cable insertion



Cu

Art. no.	CSS	d1	d4	v1	v2	TL	kg/100	PU	
291050	0,75	1,3	2,8	1	-	14	0,051	2000	100
291052	1,5	1,8	3,3	1	-	14	0,074	2000	100
291054	2,5	2,3	4,2	1	-	16	0,150	2000	100
291056	4	3,0	5,0	1	-	19	0,195	1000	100
291058	6	3,5	6,5	1	-	19	0,350	1000	100
291060	10	4,5	7,0	1	-	30	0,558	600	100
291062	16	5,5	8,5	1	1	35	0,984	500	50
291064	25	7,0	10,0	2	1	40	1,350	200	50
291066	35	8,5	12,0	2	1	45	2,150	200	50
291068	50	10,0	14,0	2	1	50	3,100	100	25
291070	70	12,0	16,5	2	1	55	4,700	50	25
291072	95	13,5	18,0	2	1	60	5,600	50	25
291074	120	15,0	19,5	2	1	65	6,800	60	15
291076	150	16,5	21,0	2	1	70	7,800	40	20
291078	185	19,0	24,0	2	1	80	11,700	30	5
291080	240	21,0	26,0	4	2	90	13,900	20	10
291082	300	23,5	29,5	4	2	100	22,300	10	5
291084	400	27,0	34,0	4	2	100	29,000	10	5

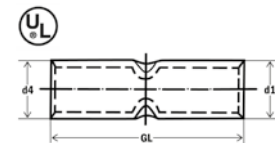

T-connectors, standard series

HUPtype

- Material: 99.9% E-CU DIN 40500
- Annealed material for easier crimping
- Surface: tin-plated
- For stranded conductors e.g. VDE 0295 class 2

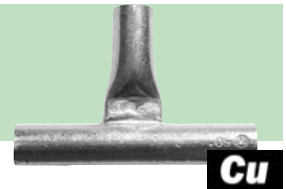

Art. no.	CSS	d1	d4	A	TL	kg/100	PU
291330	1,5	1,9	3,9	12	30	0,400	25
291332	2,5	2,4	4,4	12	30	0,400	25
291334	4	3,0	5,0	12	30	0,600	25
291336	6	3,7	5,5	14	35	1,100	25
291338	10	4,3	6,7	14	35	1,500	25
291340	16	5,4	7,8	21	50	2,300	25
291342	25	6,9	9,4	23	55	2,200	25
291344	35	8,3	11,3	30	70	3,800	25
291348	50	9,6	13,1	34	80	6,000	25
291350	70	11,5	15,3	35	85	10,100	25
291352	95	13,5	17,5	36	90	11,600	25
291354	120	15,5	20,0	38	95	17,800	10
291356	150	16,8	21,3	44	110	17,900	10
291358	185	19,0	24,0	45	115	28,300	1
291360	240	21,0	26,0	52	130	31,200	1

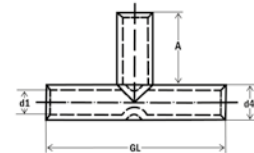

Tubular cable lugs, nylon-insulated, standard series

Nylon



Cu

- Material: 99.9% E-CU DIN 40500
- Surface: tin-plated • annealed material for easier crimping
- For stranded conductors e.g. VDE 0295 class 2
- With inspection hole • crimp directly with insulation

Art. no.	CSS	M	d2	d1	d4	A	TL	kg/100	PU
290800	10	5	5,5	7,0	9,0	17,0	35,5	0,400	100
290801		6	6,5	7,0	9,0	17,0	35,5	0,600	100
290802		8	8,5	7,0	9,0	17,0	42,0	0,500	100
290804		10	10,5	7,0	9,0	17,0	46,0	0,700	50
290806	16	5	5,5	8,5	10,5	21,0	39,5	0,600	100
290810		6	6,5	8,5	10,5	21,0	41,3	0,900	50
290812		8	8,5	8,5	10,5	21,0	45,5	1,000	50
290814		10	10,5	8,5	10,5	21,0	49,5	1,000	50
290816		12	13,0	8,5	10,5	21,0	54,0	1,000	50
290818	25	6	6,5	10,0	12,0	24,0	46,5	1,200	25
290820		8	8,5	10,0	12,0	24,0	51,0	1,300	25
290822		10	10,5	10,0	12,0	24,0	55,0	1,500	25
290824		12	13,0	10,0	12,0	24,0	57,0	1,400	25
290826	35	6	6,5	12,0	14,0	27,0	49,5	2,100	25
290830		8	8,5	12,0	14,5	27,0	54,0	2,100	25
290832		10	10,5	12,0	14,5	27,0	59,0	2,300	25
290834		12	13,0	12,0	14,5	27,0	61,0	2,300	25
290836	50	6	6,5	14,0	16,5	32,0	59,0	3,100	25
290840		8	8,5	14,0	16,5	32,0	59,0	3,100	25
290842		10	10,5	14,0	16,5	32,0	63,0	3,300	25
290844		12	13,0	14,0	16,5	32,0	68,0	3,400	25
290846		14	15,0	14,0	16,5	32,0	71,5	3,600	20
290848	70	8	8,5	16,4	18,9	33,5	65,5	3,100	15
290850		10	10,5	16,4	18,9	33,5	66,5	5,000	15
290852		12	13,0	16,4	18,9	33,5	70,5	5,000	15
290854		14	15,0	16,4	18,9	33,5	73,5	5,000	15
290856		16	17,0	16,4	18,9	33,5	78,5	5,000	15
290858	95	8	8,5	17,8	20,8	40,0	74,0	5,800	25
290860		10	10,5	17,8	20,8	40,0	74,0	5,800	25
290862		12	13,0	17,8	20,8	40,0	76,0	5,200	25
290864		14	15,0	17,8	20,8	40,0	79,5	6,200	25
290866		16	17,0	17,8	20,8	40,0	84,0	6,200	25
290868	120	8	8,5	19,3	22,3	41,5	80,5	6,500	25
290870		10	10,5	19,3	22,3	41,5	80,5	7,000	25
290872		12	13,0	19,3	22,3	41,5	80,5	6,200	20
290874		14	15,0	19,3	22,3	41,5	82,5	6,600	20
290876		16	17,0	19,3	22,3	41,5	85,5	6,500	20
290878	150	10	10,5	20,8	23,8	48,0	88,0	8,800	20
290880		12	13,0	20,8	23,8	48,0	89,0	8,400	20
290882		14	15,0	20,8	23,8	48,0	90,0	8,500	20
290884		16	17,0	20,8	23,8	48,0	92,0	8,100	20
290886		20	21,0	20,8	23,8	48,0	106,0	8,100	20

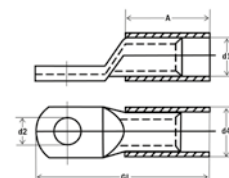

Tubular cable lugs for fine-wired, high flexible conductors

F-type

- For fine stranded conductors, DIN VDE 60228 e.g. VDE 0295 class 5/6
- Material: 99.9% E-CU DIN 40500
- Surface: tin-plated
- With inspection hole



Cu

Art. no.	CSS	M	d2	d1	d4	A	l	c1	c2	kg/100	PU	PU
290250 *	10	6	6,4	5,0	8,0	16,0	23,0	6,0	7,0	0,700	1000	100
290252		8	8,4	5,0	8,0	17,0	26,0	7,0	9,0	0,700	800	100
290254		10	10,5	5,0	8,0	16,0	26,0	8,0	10,0	0,800	600	100
290256		12	13,0	5,0	8,0	17,0	31,0	10,0	14,0	0,800	600	100
290258	16	6	6,4	6,0	9,0	17,0	26,0	7,0	9,0	0,900	600	100
290260 *		8	8,4	6,0	9,0	17,0	26,0	7,0	9,0	0,900	400	100
290262		10	10,5	6,0	9,0	16,0	28,0	10,0	12,0	1,000	400	100
290264		12	13,0	6,0	9,0	22,0	35,0	12,0	13,0	1,000	400	100
290266	25	6	6,4	8,0	11,0	20,0	30,0	7,0	10,0	1,300	400	50
290268 *		8	8,4	8,0	11,0	20,0	30,0	8,0	10,0	1,300	400	50
290270		10	10,5	8,0	11,0	20,0	32,0	10,0	12,0	1,500	300	50
290272		12	13,0	8,0	11,0	22,0	35,0	12,0	13,0	1,500	300	50
290276 *	35	8	8,4	9,0	13,0	25,0	35,0	10,0	10,0	2,500	240	40
290278		10	10,5	9,0	13,0	24,0	35,0	10,0	11,0	2,500	160	40
290280		12	13,0	9,0	13,0	26,0	40,0	12,0	14,0	2,600	160	40
290282	50	8	8,4	11,0	14,5	27,0	39,0	11,0	12,0	3,000	150	25
290284 *		10	10,5	11,0	14,5	27,0	39,0	11,0	12,0	2,900	150	25
290286 *		12	13,0	11,0	14,5	27,0	41,0	12,0	14,0	2,900	100	25
290288		16	17,0	11,0	14,5	27,0	44,0	15,0	17,0	3,000	100	25
290290	70	8	8,4	13,0	17,0	32,0	44,0	11,0	12,0	4,400	100	25
290292 *		10	10,5	13,0	17,0	32,0	44,0	11,0	12,0	4,000	100	25
290294		12	13,0	13,0	17,0	32,0	46,0	12,0	14,0	4,400	100	25
290296		16	17,0	13,0	17,0	32,0	49,0	15,0	17,0	4,500	100	25
290300	95	10	10,5	15,0	20,0	37,0	54,0	15,0	17,0	7,700	100	25
290302 *		12	13,0	15,0	20,0	37,0	54,0	15,0	17,0	7,400	100	25
290304		16	17,0	15,0	20,0	37,0	54,0	15,0	17,0	7,000	100	25
290306	120	10	10,5	17,0	22,0	41,0	58,0	15,0	17,0	9,400	80	20
290308 *		12	13,0	17,0	22,0	41,0	58,0	15,0	17,0	8,900	80	20
290310		16	17,0	17,0	22,0	41,0	58,0	15,0	17,0	8,700	72	18
290316 *	150	12	13,0	19,0	25,0	48,0	65,0	15,0	17,0	13,300	48	12
290318		16	17,0	19,0	25,0	48,0	65,0	15,0	17,0	12,700	48	12
290320		20	21,0	19,0	25,0	48,0	68,0	19,0	20,0	8,200	48	10
290322	185	12	13,0	21,0	27,0	54,0	71,0	15,0	17,0	16,200	40	20
290324		16	17,0	21,0	27,0	54,0	71,0	15,0	17,0	15,800	40	20
290326		20	21,0	21,0	27,0	54,0	74,0	19,0	20,0	14,200	40	15
290328 *	240	12	13,0	24,0	30,0	56,0	76,0	19,0	20,0	20,300	30	15
290330		16	17,0	24,0	30,0	56,0	76,0	19,0	20,0	20,700	30	15
290332		20	21,0	24,0	30,0	56,0	76,0	19,0	20,0	18,300	30	15
290334	300	12	13,0	26,0	32,0	62,0	93,0	21,0	31,0	30,000	16	8
290336		16	17,0	26,0	32,0	62,0	93,0	21,0	31,0	28,100	16	8
290338		20	21,0	26,0	32,0	62,0	93,0	21,0	31,0	26,200	16	8

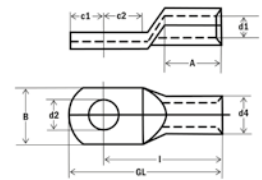

Butt-connector for fine stranded high flexible conductors

F-type

- For fine stranded conductors, DIN VDE 60228 e.g. VDE 0295 class 5/6
- Material: 99.9% E-CU DIN 40500
- Surface: tin-plated
- With buttmarks for precise cable insertion



Cu

Art. no.	CSS	d1	d4	TL	kg/100	PU	PU
290350	10	5,0	8,0	30	0,800	600	50
290352	16	6,0	9,0	35	1,000	500	50
290354	25	8,0	11,0	35	1,300	200	50
290356	35	9,0	13,0	35	2,100	200	25
290358	50	11,0	14,5	45	3,700	100	25
290360	70	13,0	17,0	45	4,600	50	25
290362	95	15,0	20,0	45	7,300	50	50
290364	120	17,0	22,0	55	6,900	50	25
290366	150	19,0	25,0	65	9,800	50	18
290368	185	21,0	27,0	70	13,600	36	18
290370	240	24,0	30,0	70	16,000	12	6
290372	300	26,0	32,0	75	7,000	6	6
290374	400	30,0	36,0	100	11,100	6	6

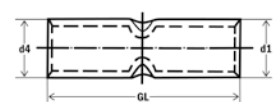

Cable lugs acc. to DIN 46235

DIN



- Material: 99,9% E-Cu DIN 40500
- Tube dimension acc. to DIN 46235 • Surface: bare
- With marks for correct crimping
- Annealed material for easier crimping

Cu

Art. no.	CSS	M	ld.	d2	d1	d4	A	v1	v2	l	c1	c2	B	kg/100	PU	
290001	6	5	5	5,3	3,8	5,5	10,0	2	-	24,0	6,5	7,5	8,5	0,300	800	100
290003		6	5	6,4	3,8	5,5	10,0	2	-	24,0	7,5	8,0	8,5	0,300	800	100
290005		8	5	8,4	3,8	5,5	10,0	2	-	24,0	10,0	10,0	13,0	0,300	800	100
290007	10	5	6	5,3	4,5	6,0	10,0	2	-	27,0	7,0	8,5	9,0	0,700	800	100
290011		6	6	6,4	4,5	6,0	10,0	2	-	27,0	7,5	8,5	9,0	0,600	800	100
290013		8	6	8,4	4,5	6,0	10,0	2	-	27,0	10,0	10,0	13,0	0,300	800	100
290015		10	6	10,5	4,5	6,0	10,0	2	-	28,0	10,0	10,0	15,0	0,500	800	100
290019	16	6	8	6,4	5,5	8,5	20,0	2	1	36,0	7,5	8,0	13,0	1,100	500	50
290021		8	8	8,4	5,5	8,5	20,0	2	1	36,0	10,0	10,0	13,0	1,100	400	50
290025		10	8	10,5	5,5	8,5	20,0	2	1	36,0	12,0	12,0	17,0	1,200	400	50
290027		12	8	13,0	5,5	8,5	20,0	2	1	36,0	13,0	13,0	18,0	1,200	400	50
290031	25	6	10	6,4	7,0	10,0	20,0	2	1	38,0	7,5	8,0	14,0	1,300	300	50
290033		8	10	8,4	7,0	10,0	20,0	2	1	38,0	10,0	10,0	16,0	1,400	300	50
290035		10	10	10,5	7,0	10,0	20,0	2	1	38,0	12,0	12,0	17,0	1,600	300	50
290037		12	10	13,0	7,0	10,0	20,0	2	1	38,0	13,0	13,0	19,0	1,400	300	50
290039	35	6	12	6,4	8,2	12,5	20,0	2	1	42,0	7,5	8,0	17,0	2,700	150	25
290042		8	12	8,4	8,2	12,5	20,0	2	1	42,0	10,0	10,0	17,0	2,900	150	15
290044		10	12	10,5	8,2	12,5	20,0	2	1	42,0	12,0	12,0	19,0	3,000	150	25
290049		12	12	13,0	8,2	12,5	20,0	2	1	42,0	13,0	13,0	21,0	2,800	150	25
290050	50	8	14	8,4	10,0	14,5	28,0	3	1	52,0	10,0	10,0	20,0	4,500	100	25
290051		10	14	10,5	10,0	14,5	28,0	3	1	52,0	12,0	12,0	22,0	4,400	100	25
290052		12	14	13,0	10,0	14,5	28,0	3	1	52,0	13,0	13,0	24,0	4,400	100	25
290053		16	14	17,0	10,0	14,5	28,0	3	1	52,0	16,0	16,0	28,0	4,300	100	20
290054	70	8	16	8,4	11,5	16,5	28,0	3	1	55,0	10,0	10,0	24,0	5,900	100	25
290055		10	16	10,5	11,5	16,5	28,0	3	1	55,0	12,0	12,0	24,0	6,000	100	25
290056		12	16	13,0	11,5	16,5	28,0	3	1	55,0	13,0	13,0	24,0	5,300	100	25
290057		16	16	17,0	11,5	16,5	28,0	3	1	55,0	16,0	16,0	30,0	5,600	80	20
290058	95	10	18	10,5	13,5	19,0	35,0	4	2	65,0	12,0	12,0	28,0	8,900	60	15
290059		12	18	13,0	13,5	19,0	35,0	4	2	65,0	13,0	13,0	28,0	8,500	60	15
290060		16	18	17,0	13,5	19,0	35,0	4	2	65,0	16,0	16,0	32,0	8,700	60	15
290061	120	10	20	10,5	15,5	21,0	35,0	4	2	70,0	15,0	16,0	32,0	11,100	40	20
290063		12	20	13,0	15,5	21,0	35,0	4	2	70,0	16,0	17,0	32,0	11,000	40	20
290064		16	20	17,0	15,5	21,0	35,0	4	2	70,0	19,0	20,0	32,0	10,600	40	20
290065		20	20	21,0	15,5	21,0	35,0	4	2	70,0	21,0	22,0	38,0	11,100	30	20
290066	150	10	22	10,5	17,0	23,5	35,0	4	2	78,0	15,0	16,0	34,0	15,800	30	15
290067		12	22	13,0	17,0	23,5	35,0	4	2	78,0	16,0	17,0	34,0	15,600	30	15
290068		16	22	17,0	17,0	23,5	35,0	4	2	78,0	19,0	20,0	34,0	15,700	30	15
290069		20	22	21,0	17,0	23,5	35,0	4	2	78,0	21,0	22,0	40,0	15,800	20	12
290070	185	10	25	10,5	19,0	25,5	40,0	4	2	82,0	15,0	16,0	37,0	17,200	20	10
290071		12	25	13,0	19,0	25,5	40,0	4	2	82,0	16,0	17,0	37,0	18,300	20	10
290072		16	25	17,0	19,0	25,5	40,0	4	2	82,0	19,0	20,0	37,0	17,700	20	10
290073		20	25	21,0	19,0	25,5	40,0	4	2	82,0	21,0	22,0	40,0	18,900	20	10
290074	240	12	28	13,0	21,5	29,0	40,0	5	2	92,0	16,0	17,0	42,0	26,400	16	8
290075		16	28	17,0	21,5	29,0	40,0	5	2	92,0	19,0	20,0	42,0	26,900	16	8
290076		20	28	21,0	21,5	29,0	40,0	5	2	92,0	21,0	22,0	45,0	26,900	16	8
290077	300	16	32	17,0	24,5	32,0	50,0	-	2	100,0	19,0	22,0	46,0	33,000	8	4
290078		20	32	21,0	24,5	32,0	50,0	-	2	100,0	19,0	22,0	46,0	33,000	8	4
290079	400	16	38	17,0	27,5	38,5	70,0	-	3	115,0	25,0	25,0	55,0	70,200	6	6
290080		20	38	21,0	27,5	38,5	70,0	-	3	115,0	25,0	25,0	54,0	45,100	6	6
290081	500	20	42	21,0	31,0	42,0	70,0	-	3	125,0	25,0	25,0	60,0	76,600	6	6
290082	625	20	44	21,0	34,5	44,0	80,0	-	3	125,0	25,0	25,0	64,0	78,000	1	1
290083	800	20	52	21,0	40,0	52,0	100,0	-	3	165,0	30,0	30,0	75,0	148,600	1	1
290084	1000	20	58	21,0	44,0	58,0	100,0	-	3	165,0	30,0	30,0	83,0	195,200	1	1

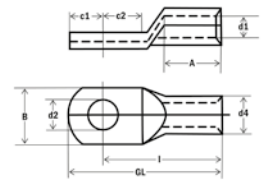

Compression joints acc. to DIN 46267 Part 1 (for non-tension connections)

DIN



Cu

- Material: 99.9% E-Cu DIN 40500
- Surface: bare
- With marks for correct crimping
- Annealed material for easier crimping

Art. no.	CSS	ld.	d1	d4	v1	v2	TL	kg/100	PU
291520	6	5	3,8	5,5	2	-	30	0,300	1600
291522	10	6	4,5	6,0	2	-	30	0,600	1000
291524	16	8	5,5	8,5	2	1	50	1,450	300
291526	25	10	7,0	10,0	2	1	50	1,700	300
291528	35	12	8,2	12,5	2	1	50	3,100	200
291530	50	14	10,0	14,5	3	1	55	4,400	100
291532	70	16	11,5	16,5	3	1	55	5,300	100
291534	95	18	13,5	19,0	4	2	70	8,400	50
291536	120	20	15,5	21,0	4	2	70	9,600	50
291538	150	22	17,0	23,5	4	2	80	14,500	30
291540	185	25	19,0	25,5	4	2	85	16,200	30
291542	240	28	21,5	29,0	5	2	90	22,400	20
291544	300	32	24,5	32,0	-	2	100	29,500	10
291546	400	38	27,5	38,5	-	3	150	72,500	8
291548	500	42	31,0	42,0	-	3	160	85,600	5
291550	625	44	34,5	44,0	-	3	160	79,900	6
291552	800	52	40,0	52,0	-	3	200	151,000	6
291554	1000	58	44,0	58,0	-	3	1000	198,000	6

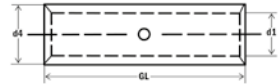

Compression joints acc. to DIN 48085, Part 1 (for full-tension cable connections)

DIN



Cu

- Material: 99.9% E-Cu DIN 40500 • Surface: bare
- With marks for correct crimping
- Annealed material for easier crimping
- For full-tension cable connections, overhead line construction

Art. no.	CSS	ld.	d1	d4	v1	v2	TL	kg/100	PU
291440	6	6	3,8	6,5	8	-	65	1,200	50
291442	10	8	4,5	8,5	10	-	80	2,800	50
291444	16	8	5,5	8,5	10	-	95	2,300	50
291446	25	10	7,0	10,0	10	-	95	2,600	50
291448	35	12	8,2	12,5	10	-	95	5,800	25
291450	50	14	10,0	14,5	10	-	110	7,000	25
291452	70	16	11,5	16,5	10	-	110	9,000	25
291454	95	20	13,5	21,0	16	8	145	8,600	10
291456	120	22	15,0	23,5	16	8	160	36,800	10
291458	150	25	16,5	25,5	16	8	180	47,500	10
291460	185	32	18,5	31,5	-	10	260	118,000	5
291462	240	34	21,0	34,5	-	12	310	163,000	5
291464	300	38	23,5	38,5	-	14	360	235,000	5

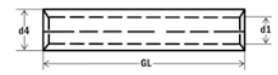

Cable lugs acc. to DIN 46235

DIN



- Material: 99,9% E-Cu DIN 40500
- Tube dimension acc. to DIN 46235 • Surface: tin-plated
- With marks for correct crimping
- Annealed material for easier crimping

Art. no.	CSS	M	ld.	d2	d1	d4	A	v1	v2	l	c1	c2	B	kg/100	PU	
290404 *	6	6	5	6,4	3,8	5,5	10,0	2	-	24,0	7,5	8,0	8,5	0,300	800	100
290406		8	5	8,4	3,8	5,5	10,0	2	-	24,0	10,0	10,0	13,0	0,300	800	100
290408	10	5	6	5,3	4,5	6,0	10,0	2	-	27,0	7,0	8,5	9,0	0,400	800	100
290410 *		6	6	6,4	4,5	6,0	10,0	2	-	27,0	7,5	8,5	9,0	0,400	800	100
290412 *		8	6	8,4	4,5	6,0	10,0	2	-	27,0	10,0	10,0	13,0	0,400	800	100
290414		10	6	10,5	4,5	6,0	10,0	2	-	28,0	10,0	10,0	15,0	0,400	800	100
290416	16	6	8	6,4	5,5	8,5	20,0	2	1	36,0	7,5	8,0	13,0	1,200	500	50
290418 *		8	8	8,4	5,5	8,5	20,0	2	1	36,0	10,0	10,0	13,0	1,200	400	50
290420		10	8	10,5	5,5	8,5	20,0	2	1	36,0	12,0	12,0	17,0	1,100	400	50
290422		12	8	13,0	5,5	8,5	20,0	2	1	36,0	13,0	13,0	18,0	1,200	400	50
290424	25	6	10	6,4	7,0	10,0	20,0	2	1	38,0	7,5	8,0	14,0	1,300	300	50
290426 *		8	10	8,4	7,0	10,0	20,0	2	1	38,0	10,0	10,0	16,0	1,400	300	50
290428		10	10	10,5	7,0	10,0	20,0	2	1	38,0	12,0	12,0	17,0	1,600	300	50
290430		12	10	13,0	7,0	10,0	20,0	2	1	38,0	13,0	13,0	19,0	1,500	300	50
290432	35	6	12	6,4	8,2	12,5	20,0	2	1	42,0	7,5	8,0	17,0	2,700	150	25
290434 *		8	12	8,4	8,2	12,5	20,0	2	1	42,0	10,0	10,0	17,0	2,900	150	25
290436		10	12	10,5	8,2	12,5	20,0	2	1	42,0	12,0	12,0	19,0	2,900	150	25
290438		12	12	13,0	8,2	12,5	20,0	2	1	42,0	13,0	13,0	21,0	2,700	150	25
290440	50	8	14	8,4	10,0	14,5	28,0	3	1	52,0	10,0	10,0	20,0	4,400	100	25
290442 *		10	14	10,5	10,0	14,5	28,0	3	1	52,0	12,0	12,0	22,0	4,500	100	25
290444		12	14	13,0	10,0	14,5	28,0	3	1	52,0	13,0	13,0	24,0	4,400	100	25
290446		16	14	17,0	10,0	14,0	28,0	3	1	52,0	16,0	16,0	28,0	4,200	100	20
290448	70	8	16	8,4	11,5	16,5	28,0	3	1	55,0	10,0	10,0	24,0	5,900	100	25
290450 *		10	16	10,5	11,5	16,5	28,0	3	1	55,0	12,0	12,0	24,0	5,900	100	25
290452		12	16	13,0	11,5	16,5	28,0	3	1	55,0	13,0	13,0	24,0	5,900	100	25
290454		16	16	17,0	11,5	16,5	28,0	3	1	55,0	16,0	16,0	30,0	5,800	80	20
290456 *	95	10	18	10,5	13,5	19,0	35,0	4	2	65,0	12,0	12,0	28,0	8,800	60	15
290458 *		12	18	13,0	13,5	19,0	35,0	4	2	65,0	13,0	13,0	28,0	8,900	60	15
290460		16	18	17,0	13,5	19,0	35,0	4	2	65,0	16,0	16,0	32,0	8,700	60	15
290462	120	10	20	10,5	15,5	21,0	35,0	4	2	70,0	15,0	16,0	32,0	11,000	40	20
290464 *		12	20	13,0	15,5	21,0	35,0	4	2	70,0	16,0	17,0	32,0	11,100	40	20
290466		16	20	17,0	15,5	21,0	35,0	4	2	70,0	19,0	20,0	32,0	10,500	40	20
290468		20	20	21,0	15,5	21,0	35,0	4	2	70,0	21,0	22,0	38,0	11,300	30	15
290470	150	10	22	10,5	17,0	23,5	35,0	4	2	78,0	15,0	16,0	34,0	15,600	30	15
290472 *		12	22	13,0	17,0	23,5	35,0	4	2	78,0	16,0	17,0	34,0	15,700	30	15
290474		16	22	17,0	17,0	23,5	35,0	4	2	78,0	19,0	20,0	34,0	15,900	30	15
290476		20	22	21,0	17,0	23,5	35,0	4	2	78,0	21,0	22,0	40,0	16,000	25	25
290478	185	10	25	10,5	19,0	25,5	40,0	4	2	82,0	15,0	16,0	37,0	18,000	20	10
290480 *		12	25	13,0	19,0	25,5	40,0	4	2	82,0	16,0	17,0	37,0	18,400	20	10
290482 *		16	25	17,0	19,0	25,5	40,0	4	2	82,0	19,0	20,0	37,0	18,400	20	10
290484		20	25	21,0	19,0	25,5	40,0	4	2	82,0	21,0	22,0	40,0	17,700	20	10
290486 *	240	12	28	13,0	21,5	29,0	40,0	5	2	92,0	16,0	17,0	42,0	26,500	16	8
290488 *		16	28	17,0	21,5	29,0	40,0	5	2	92,0	19,0	20,0	42,0	26,600	16	8
290490		20	28	21,0	21,5	29,0	40,0	5	2	92,0	21,0	22,0	45,0	27,600	16	8
290492	300	16	32	17,0	24,5	32,0	50,0	-	2	100,0	19,0	22,0	46,0	34,300	10	5
290494		20	32	21,0	24,5	32,0	50,0	-	2	100,0	19,0	22,0	46,0	33,100	10	5
290496	400	16	38	17,0	27,5	38,5	70,0	-	3	115,0	25,0	25,0	54,0	69,800	6	3
290498		20	38	21,0	27,5	38,5	70,0	-	3	115,0	25,0	25,0	54,0	66,400	8	1
290516	500	20	42	21,0	31,0	42,0	70,0	-	3	125,0	25,0	25,0	60,0	82,600	8	1
290518	625	20	44	21,0	34,5	44,0	80,0	-	3	125,0	25,0	25,0	64,0	79,000	6	1
290520	800	20	52	21,0	40,0	52,0	100,0	-	3	165,5	30,0	30,0	75,0	139,400	6	1
290522	1000	20	58	21,0	44,0	58,0	100,0	-	3	165,0	30,0	30,0	83,0	195,000	6	1

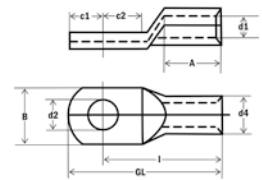

Cable lugs "SmallPack" acc. to DIN 46235

- **Werks Material: 99,9% electrolytic copper toff: 99,9% Elektrolyt-Kupfer, geglühtes Material**
- **Surface: tin-plated**

Art. no.	CSS	M	ld.	d2	d1	d4	A	v1	v2	l	c1	c2	B	kg/100	VE
290404/10	6	6	5	6,4	3,8	5,5	10,0	2	-	24,0	7,5	8,0	8,5	0,300	10
290406/10		8	5	8,4	3,8	5,5	10,0	2	-	24,0	10,0	10,0	13,0	0,300	10
290410/10	10	6	6	6,4	4,5	6,0	10,0	2	-	27,0	7,5	8,5	9,0	0,400	10
290412/10		8	6	8,4	4,5	6,0	10,0	2	-	27,0	10,0	10,0	13,0	0,400	10
290416/10	16	6	8	6,4	5,5	8,5	20,0	2	1	36,0	7,5	8,0	13,0	1,200	10
290418/10		8	8	8,4	5,5	8,5	20,0	2	1	36,0	10,0	10,0	13,0	1,200	10
290420/10		10	8	10,5	5,5	8,5	20,0	2	1	36,0	12,0	12,0	17,0	1,100	10
290426/10	25	8	10	8,4	7,0	10,0	20,0	2	1	38,0	10,0	10,0	16,0	1,400	10
290428/10		10	10	10,5	7,0	10,0	20,0	2	1	38,0	12,0	12,0	17,0	1,600	10
290434/10	35	8	12	8,4	8,2	12,5	20,0	2	1	42,0	10,0	10,0	17,0	2,900	10
290436/10		10	12	10,5	8,2	12,5	20,0	2	1	42,0	12,0	12,0	19,0	2,900	10



Sleeves for round compacted conductors DIN

- **for multiple-wire, thinned, compacted conductors (e.g. VDE 0295 Kl. 2)**
- **for securely pressed and processed DIN cable lugs and connectors**
- **Material: CU EN 13600**
- **Surface: tin-plated**

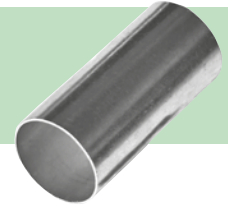

Art. no.	CSS	d1	d4	TL	kg/100	VE
290561	16	5,0	5,3	16	0,024	100
290562	25	6,4	6,7	16	0,038	100
290563	35	7,7	8,2	17	0,083	100
290564	50	9,0	9,5	23	0,118	50
290565	70	10,6	11,2	24	0,173	50
290566	95	12,4	13,0	28	0,223	50
290567	120	13,9	14,5	30	0,261	50
290568	150	15,4	16,0	30	0,342	25
290569	185	17,6	18,2	38	0,396	25
290570	240	19,9	20,5	38	0,508	25
290571	300	22,4	23,0	48	0,723	5
290572	400	25,4	26,2	58	1,108	5

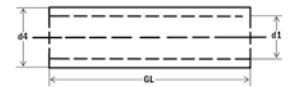

Tubular terminals

Angled cable lugs 90° acc. to DIN 46325

DIN

- Material: 99,9% E-Cu DIN 40500
- Tube dimension acc. to DIN 46235 • Surface: tin-plated
- With marks for correct crimping
- Annealed material for easier crimping



Cu

Art. no.	CSS	M	ld.	d2	d1	d4	A	v1	v2	c1	c2	kg/100	PU
291700	6	5	5	5,3	3,8	5,5	10,0	2	-	6,5	9,0	0,400	100
291702	6	5	5	6,4	3,8	5,5	10,0	2	-	7,5	10,0	0,300	100
291704 *	10	5	6	5,3	4,5	6,0	10,0	2	-	7,0	10,0	0,400	100
291706	6	6	6	6,4	4,5	6,0	10,0	2	-	7,5	10,0	0,500	100
291708	8	6	6	8,4	4,5	6,0	10,0	2	-	10,0	13,0	1,100	100
291710	16	6	8	6,4	5,5	8,5	20,0	2	1	7,5	11,0	1,200	50
291712	8	8	8	8,4	5,5	8,5	20,0	2	1	10,0	13,0	1,100	50
291714 *	10	8	8	10,5	5,5	8,5	20,0	2	1	12,0	15,0	1,200	50
291716	12	8	8	13,0	5,5	8,5	20,0	2	1	13,0	18,0	1,200	50
291718	25	6	10	6,4	7,0	10,0	20,0	2	1	7,5	11,0	1,500	50
291720	8	10	10	8,4	7,0	10,0	20,0	2	1	10,0	13,0	1,500	50
291722 *	10	10	10	10,5	7,0	10,0	20,0	2	1	12,0	15,0	1,500	50
291724	12	10	10	13,0	7,0	10,0	20,0	2	1	13,0	18,0	1,500	50
291726	35	8	12	8,4	8,2	12,5	20,0	2	1	10,0	13,0	2,600	25
291728 *	10	12	12	10,5	8,2	12,5	20,0	2	1	12,0	15,0	2,900	25
291730	12	12	12	13,0	8,2	12,5	20,0	2	1	13,0	18,0	2,900	25
291732	50	8	14	8,4	10,0	14,0	28,0	3	1	10,0	16,0	4,100	25
291734	10	14	14	10,5	10,0	14,0	28,0	3	1	12,0	16,0	4,200	20
291736 *	12	14	14	13,0	10,0	14,5	28,0	3	1	13,0	18,0	4,500	20
291738	16	14	14	17,0	10,0	14,5	28,0	3	1	16,0	22,0	4,100	20
291740	70	8	16	8,4	11,5	16,5	28,0	3	1	10,0	14,0	5,400	30
291742	10	16	16	10,5	11,5	16,5	28,0	3	1	12,0	16,0	5,500	30
291744 *	12	16	16	13,0	11,5	16,5	28,0	3	1	13,0	18,0	6,000	15
291746	16	16	16	17,0	11,5	16,5	28,0	3	1	16,0	22,0	5,600	30
291748	95	10	18	10,5	13,5	19,0	35,0	4	2	12,0	17,0	8,400	10
291750	12	18	18	13,0	13,5	19,0	35,0	4	2	13,0	18,0	8,700	10
291752	16	18	18	17,0	13,5	19,0	35,0	4	2	16,0	22,0	8,700	10
291754	120	10	20	10,5	15,5	21,0	35,0	4	2	15,0	17,0	10,000	20
291756	12	20	20	13,0	15,5	21,0	35,0	4	2	16,0	18,0	10,000	20
291758 *	16	20	20	17,0	15,5	21,0	35,0	4	2	18,0	22,0	10,200	20
291760	20	20	20	21,0	15,5	21,0	35,0	4	2	21,0	24,0	9,800	15
291762	150	10	22	10,5	17,0	23,5	35,0	4	2	15,0	17,0	13,100	15
291764	12	22	22	13,0	17,0	23,5	35,0	4	2	16,0	18,0	13,200	15
291766 *	16	22	22	17,0	17,0	23,5	35,0	4	2	19,0	22,0	14,100	15
291768	20	22	22	21,0	17,0	23,5	35,0	4	2	21,0	24,0	13,700	10
291770	185	10	25	10,5	19,0	25,5	40,0	4	2	15,0	22,0	16,400	10
291772	12	25	25	13,0	19,0	25,5	40,0	4	2	16,0	22,0	15,600	10
291774	16	25	25	17,0	19,0	25,5	40,0	4	2	19,0	22,0	18,600	10
291776	20	25	25	21,0	19,0	25,5	40,0	4	2	21,0	24,0	17,500	10
291778	240	12	28	13,0	21,5	29,0	40,0	5	2	16,0	22,0	22,400	10
291780	16	28	28	17,0	21,5	29,0	40,0	5	2	19,0	22,0	22,900	10
291782	20	28	28	21,0	21,5	29,0	40,0	5	2	21,0	24,0	21,000	10

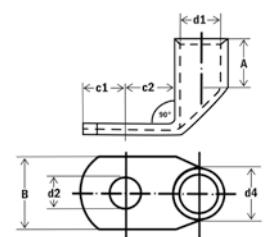

Compression joints acc. to DIN 46267, Part 1 (for non-tension connections)

DIN

- Material: 99,9% E-CU DIN 40500 • Tube dimension acc. to DIN
- Surface: tin-plated • Annealed material for easier crimping
- For stranded conductors e.g. VDE 0295 class 2
- With buttmarks for precise cable insertion



Cu

Art. no.	CSS	ld.	d1	d4	v1	v2	TL	kg/100	PU
291521	6	5	3,8	5,5	2	-	30	0,300	1600
291523	10	6	4,5	6,0	2	-	30	0,600	1000
291525	16	8	5,5	8,5	2	1	50	1,450	300
291527	25	10	7,0	10,0	2	1	50	1,600	300
291529	35	12	8,2	12,5	2	1	50	3,000	200
291531	50	14	10,0	14,5	3	1	55	4,100	100
291533	70	16	11,5	16,5	3	1	55	5,400	100
291535	95	18	13,5	19,0	4	2	70	8,300	50
291537	120	20	15,5	21,0	4	2	70	9,500	50
291539	150	22	17,0	23,5	4	2	80	14,200	30
291541	185	25	19,0	25,5	4	2	85	16,900	30
291543	240	28	21,5	29,0	5	2	90	22,600	20
291545	300	32	24,5	32,0	-	2	100	29,700	10
291547	400	38	27,5	38,5	-	3	150	74,000	8
291549	500	42	31,0	42,0	-	3	160	89,100	5
291551	625	44	34,5	44,0	-	3	160	79,000	1
291553	800	52	40,0	52,0	-	3	200	151,300	1
291555	1000	58	44,0	58,0	-	3	1000	198,000	1

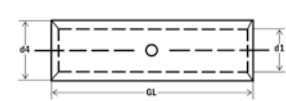

haupa®

...convincing solutions

Nickel terminals

Tubular cable lugs of pure nickel, ring type

- Material: nickel
- Temperature resistant to 500° C



Ni

Art. no.	CSS	M	d2	d1	A	l	kg/100	PU
292560	0,5	4	4,3	1,6	13,0	6,0	0,105	100
292562		5	5,3	1,6	14,0	6,0	0,086	100
292564	1,5 - 2,5	4	4,3	2,3	13,0	6,0	0,109	100
292566		5	5,3	2,3	14,0	6,0	0,122	100
292568		6	6,5	2,3	16,0	6,0	0,134	100
292570	4 - 6	4	4,3	3,6	18,0	8,0	0,300	100
292572		5	5,3	3,6	19,0	8,0	0,200	100
292574		6	6,5	3,6	19,0	8,0	0,300	100

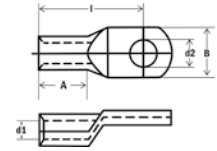

Tubular terminals of pure nickel, forke type

- Material: nickel
- Temperature resistant to 500° C



Ni

Art. no.	CSS	M	d2	d1	A	l	kg/100	PU
292580	0,5	4	4,3	1,6	13,0	6,0	0,073	100
292582		5	5,3	1,6	14,0	6,0	0,070	100
292584	1,5 - 2,5	4	4,3	2,3	13,0	6,0	0,100	100
292586		5	5,3	2,3	14,0	6,0	0,100	100
292588		6	6,5	2,3	16,0	6,0	0,110	100
292590	4 - 6	4	4,3	3,6	18,0	8,0	0,300	100
292592		5	5,3	3,6	19,0	8,0	0,300	100

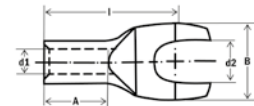

Butt-connectors, made from pure nickel

- Material: nickel
- Temperature resistant to 500° C
- With buttmarks for precise cable insertion



Ni

Art. no.	CSS	d1	TL	kg/100	PU
292596	0,5 - 1	1,6	15	0,101	100
292598	1,5 - 2,5	2,3	15	0,110	100
292600	4 - 6	3,6	15	0,190	100

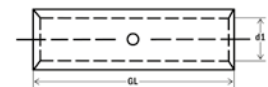

Aluminium standard conduit terminals

- Material: E-Al 99.5% • Surface: bare
- For strain-relieved connections of aluminium conductors according to DIN EN 60228 and aluminium cables according to DIN EN 50182
- For round shaped sector conductors • Including contact grease



NEW

AI

Art. no.	CSS	M	d2	d1	TL	A	kg/100	PU
294500	16	6	6,4	5,2	47,0	23,0	0,504	50
294502		8	8,4	5,2	47,0	23,0	0,490	50
294504		10	10,5	5,2	47,0	23,0	0,480	50
294506	25	6	8,4	6,4	58,0	23,0	0,740	50
294508		8	8,4	6,4	58,0	23,0	0,724	50
294510		10	10,5	6,4	58,0	23,0	0,700	50
294512	35	8	8,4	7,6	60,0	28,0	0,974	50
294514		10	10,5	7,6	60,0	28,0	0,940	50
294516	50	8	8,4	9,2	72,0	34,0	1,528	50
294518		10	10,5	9,2	72,0	34,0	1,498	50
294520		12	13	9,2	72,0	34,0	1,384	50
294522		16	17	9,2	72,0	34,0	1,260	50
294524	70	8	8,4	10,6	78,0	40,0	1,998	50
294526		10	10,5	10,6	78,0	40,0	1,940	50
294528		12	13	10,6	78,0	40,0	1,880	50
294530		16	17	10,6	78,0	40,0	1,830	50
294532	95	10	10,5	12,8	80,0	43,0	2,545	20
294534		12	13	12,8	80,0	43,0	2,440	20
294536		16	17	12,8	80,0	43,0	2,370	20
294538	120	8	8,4	14,3	97,0	52,0	3,630	20
294540		10	10,5	14,3	97,0	52,0	3,590	20
294542		12	13	14,3	97,0	52,0	3,545	20
294544		14	15	14,3	97,0	52,0	3,490	20
294546	150	8	8,4	16,2	106,0	55,0	4,830	20
294548		10	10,5	16,2	106,0	55,0	4,730	20
294550		12	13	16,2	106,0	55,0	4,625	20
294552		16	17	16,2	106,0	55,0	4,530	20
294554	185	8	8,4	17,8	110,0	60,0	5,720	20
294556		10	10,5	17,8	110,0	60,0	5,680	20
294558		12	13	17,8	110,0	60,0	5,495	20
294560		16	17	17,8	110,0	60,0	5,465	20
294562	240	8	8,4	20,2	110,0	64,0	9,870	20
294564		10	10,5	20,2	110,0	64,0	9,925	20
294566		12	13	20,2	110,0	64,0	9,810	20
294568		14	15	20,2	110,0	64,0	9,690	20
294570		16	17	20,2	110,0	64,0	9,570	20

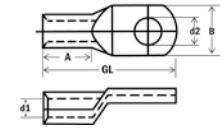

Aluminium standard butt connector

- Material: E-Al 99.5% • Surface: bare
- For strain-relieved connections of aluminium conductors according to DIN EN 60228 and aluminium cables according to DIN EN 50182
- For round shaped sector conductors • Including contact grease



NEW

AI

Art. no.	CSS	d1	TL	kg/100	PU
294580	16	5,2	50	0,620	50
294582	25	6,4	58	0,834	50
294584	35	7,6	63	1,170	50
294586	50	9,2	76	1,828	50
294588	70	10,6	84	2,578	50
294590	95	12,8	96	3,315	20
294592	120	14,3	105	4,160	20
294594	150	16,2	120	5,760	20
294596	185	17,8	125	6,935	20
294598	240	20,2	136	11,180	20

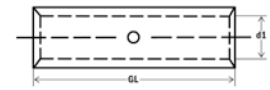

Al compression cable lugs

DIN



Al

- Material: E-Al 99.5% • Pipe measurements according to DIN 46329 • Surface: bare • Crimp marking
- For strain-relieved connections of aluminium conductors according to DIN EN 60228 and aluminium cables according to DIN EN 50182 • For round shaped sector conductors
- Including contact grease

Art. no.	CSS m/sm	se	M	ld.	d2	d1	v1	v2	l	B	kg/100	PU
292904 *	16	25	8	12	8,5	5,8	4	2	52,0	18,0	1,400	50
292906			10	12	10,5	5,8	4	2	52,0	18,0	1,400	50
292908 *	25	35	8	12	8,5	6,8	4	2	60,0	18,0	1,400	50
292910			10	12	10,5	6,8	4	2	60,0	18,0	1,400	50
292912 *	35	50	10	14	10,5	8,0	5	2	67,0	21,0	2,100	50
292914			12	14	13,0	8,0	5	2	67,0	21,0	2,000	50
292916 *	50	70	10	16	10,5	9,8	5	2	72,0	25,0	2,700	50
292918			12	16	13,0	9,8	5	2	72,0	25,0	2,700	50
292920 *	70	95	10	18	10,5	11,2	6	3	86,0	28,0	4,400	40
292922			12	18	13,0	11,2	6	3	86,0	28,0	4,200	40
292924	95	120	10	22	10,5	13,2	6	3	90,0	32,0	6,300	25
292926 *			12	22	13,0	13,2	6	3	90,0	32,0	6,400	30
292928 *			16	22	17,0	13,2	6	3	90,0	34,0	6,400	25
292930 *	120	150	12	22	13,0	14,7	6	3	91,0	32,0	6,700	25
292932			16	22	17,0	14,7	6	3	91,0	34,0	7,000	25
292934 *	150	185	12	25	13,0	16,3	6	3	103,0	35,0	9,400	20
292936			16	25	17,0	16,3	6	3	103,0	35,0	8,300	20
292938			20	25	21,0	16,3	6	3	103,0	41,0	9,100	20
292940 *	185	240	12	28	13,0	18,3	6	3	106,0	40,0	11,700	15
292942			16	28	17,0	18,3	6	3	106,0	40,0	11,600	15
292944			20	28	21,0	18,3	6	3	106,0	40,0	12,000	15
292946 *	240	300	12	32	13,0	21,0	8	3	116,0	45,0	16,900	10
292948			16	32	17,0	21,0	8	3	116,0	45,0	16,900	12
292950			20	32	21,0	21,0	8	3	116,0	45,0	16,200	10

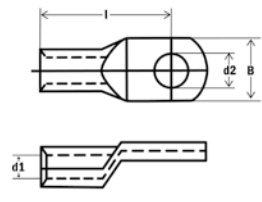

Al compression cable lugs acc. to DIN 46329

DIN

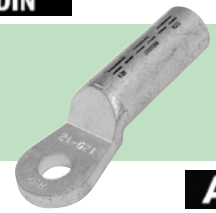

Al

- Extrusion moulded version • Material: E-Al 99.5%
- Pipe measurements according to DIN 46329 • Surface: bare • Crimp marking
- For strain-relieved connections of aluminium conductors according to DIN EN 60228 and aluminium cables according to DIN EN 50182 • For round shaped sector conductors • Including contact grease

Art. no.	CSS m/sm	se	M	ld.	d2	d1	v1	v2	l	B	kg/100	PU
292770	35	50	10	14	10,5	8,0	5	2	62,0	25,0	2,000	50
292772			12	14	13,0	8,0	5	2	62,0	25,0	2,000	50
292774	50	70	10	16	10,5	9,8	5	2	62,0	25,0	2,800	50
292776			12	16	13,0	9,8	5	2	62,0	25,0	2,600	50
292778 *	70	95	10	18	10,5	11,2	6	3	72,0	25,0	3,900	25
292780			12	18	13,0	11,2	6	3	72,0	25,0	3,500	25
292782 *	95	120	10	22	10,5	13,2	6	3	75,0	25,0	5,900	25
292784			12	22	13,0	13,2	6	3	75,0	25,0	5,600	25
292786 *	120	150	12	22	13,0	14,7	6	3	80,0	30,0	6,400	25
292788			16	22	17,0	14,7	6	3	80,0	30,0	6,600	25
292790 *	150	185	10	25	10,5	16,3	6	3	90,0	30,0	8,400	25
292792			12	25	13,0	16,3	6	3	90,0	30,0	8,300	25
292794			16	25	17,0	16,3	6	3	90,0	30,0	8,200	20
292796	185	240	10	28	10,5	18,3	6	3	91,0	30,0	10,400	20
292798 *			12	28	13,0	18,3	6	3	91,0	30,0	10,500	20
292800			16	28	17,0	18,3	6	3	91,0	30,0	12,000	20
292802 *	240	300	12	32	13,0	21,0	8	3	103,0	38,0	16,100	10
292804			16	32	17,0	21,0	8	3	103,0	38,0	15,900	10
292806			20	32	21,0	21,0	8	3	103,0	38,0	15,200	10
292808 *	300	-	12	34	13,0	23,3	8	3	103,0	38,0	17,200	10
292810			16	34	17,0	23,3	8	3	103,0	38,0	18,500	10
292812			20	34	21,0	23,3	8	3	103,0	38,0	17,300	10
292814	400	-	12	38	13,0	26,0	-	4	116,0	38,0	24,700	10
292816			16	38	17,0	26,0	-	4	116,0	38,0	23,000	10
292818			20	38	21,0	26,0	-	4	116,0	38,0	23,500	10
292820	500	-	12	44	13,0	29,0	-	4	122,0	44,0	43,600	6
292822			16	44	17,0	29,0	-	4	155,0	44,0	33,200	6
292824			20	44	21,0	29,0	-	4	122,0	44,0	43,000	6

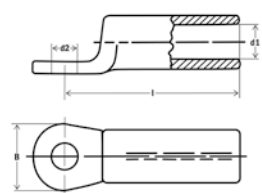

Pressing terminals and connectors

Al-Crimp connector DIN 46267 Part 2

DIN

- Material: E-Al 99.5%
- Pipe measurements according to DIN 46329 • Surface: bare • Crimp marking
- For strain-relieved connections of aluminium conductors according to DIN EN 60228 and aluminium cables according to DIN EN 50182 • For round shaped sector conductors • Including contact grease



Al

Art. no.	CSS rm/sm	se	d1	v1	v2	TL	ld./Al	kg/100	PU
293542	25	35	6,8	8	4	70	12	1,600	100
293544	35	50	8,0	10	4	85	14	2,700	100
293546	50	70	9,8	10	4	85	16	3,300	50
293548	70	95	11,2	12	6	105	18	5,800	50
293550	95	120	13,2	12	6	105	22	8,200	25
293552	120	150	14,7	12	6	105	22	7,900	25
293554	150	185	16,3	12	6	125	25	11,500	25
293556	185	240	18,3	12	6	125	28	12,300	20
293558	240	300	20,0	16	6	145	32	21,200	15

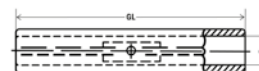

Al and Cu cable lugs, longitudinally sealed

DIN

- Material: E-Al 99.5% , E-Cu • Pipe measurements according to DIN 46329
- Surface: bare • Crimp marking
- For strain-relieved connections of aluminium conductors according to DIN EN 60228 and aluminium cables according to DIN EN 50182 • For round shaped sector conductors • Including contact grease

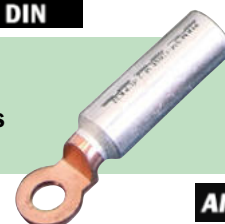

Al.Cu

Art. no.	CSS rm/sm	se	M	ld.	d2	d1	v1	v2	l	B	kg/100	PU
293300 *	25	35	8	12	10,5	6,8	4	2	61,0	23,0	2,600	50
293302			10	12	10,5	6,8	4	2	61,0	23,0	2,500	50
293304			12	12	13,0	6,8	4	2	61,0	23,0	2,900	50
293306 *	35	50	10	14	10,5	8,0	5	2	71,0	23,0	3,200	50
293308			12	14	13,0	8,0	5	2	71,0	23,0	3,500	50
293310 *	50	70	10	16	10,5	9,8	5	2	72,0	25,0	3,400	50
293312			12	16	13,0	9,8	5	2	72,0	25,0	4,100	50
293314 *	70	95	10	18	10,5	11,2	6	3	82,0	26,0	6,100	50
293316			12	18	13,0	11,2	6	3	82,0	26,0	5,500	50
293318 *	95	120	12	22	13,0	13,2	6	3	85,0	30,0	8,200	25
293320			16	22	17,0	13,2	6	3	85,0	30,0	8,500	25
293322 *	120	150	12	22	13,0	14,7	6	3	87,0	30,0	8,500	25
293324			16	22	17,0	14,7	6	3	87,0	30,0	8,700	25
293326 *	150	185	12	25	13,0	16,3	6	3	104,0	36,0	11,000	25
293328			16	25	17,0	16,3	6	3	104,0	36,0	11,200	25
293330 *	185	240	12	28	13,0	18,3	6	3	105,0	36,0	14,100	10
293332			16	28	17,0	18,3	6	3	105,0	36,0	14,300	10
293334 *	240	300	12	32	13,0	21,0	8	3	120,0	36,0	18,000	5
293336			20	32	17,0	21,0	8	3	120,0	36,0	29,000	5
293338 *	300	300	12	34	13,0	23,3	8	3	120,0	38,0	35,000	5

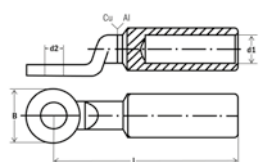

Al/Cu non-tension compression joints with Cu bolt

DIN

- Material: E-Al 99.5% , E-Cu • Pipe measurements according to DIN 46329
- Surface: bare • Crimp marking
- For strain-relieved connections of aluminium conductors according to DIN EN 60228 and aluminium cables according to DIN EN 50182 • For round shaped sector conductors • Including contact grease

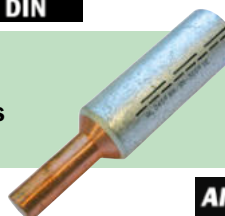

Al.Cu

Art. no.	CSS rm/sm	se	d1	d4	TL	l	Øbo.	Ørope	ld./Al	kg/100	PU
293960	25	35	6,8	12,0	58	20,0	6	6,3	12	1,600	1
293962	35	35	8,0	14,0	71	22,0	7	7,5	14	2,800	1
293964	50	50	10,0	16,0	74	25,0	8	9,0	16	3,800	1
293966	70	70	11,5	18,5	87	30,0	10	10,0	18	5,400	1
293968	95	120	13,2	23,0	91	33,0	12	12,5	22	10,600	1
293970	120	150	15,0	23,0	97	38,0	12	14,0	22	9,000	1
293972	150	185	16,5	25,5	108	38,0	12	15,8	25	10,900	1
293974	185	240	18,5	28,5	116	44,0	14	17,5	28	15,700	1
293976	240	300	21,5	32,5	128	44,0	16	20,3	32	17,000	1
293978	300	-	23,5	34,5	131	46,0	18	22,5	34	23,200	1

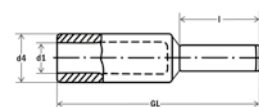

haupa®

...convincing solutions

Al-Cu reducing connectors

DIN

- Material: E-Al 99.5% , E-Cu • Pipe measurements according to DIN 46329
- Surface: bare • Crimp marking
- For strain-relieved connections of aluminium conductors according to DIN EN 60228 and aluminium cables according to DIN EN 50182 • For round shaped sector conductors • Including contact grease



Al.Cu

Art. no.	CSS rm/sm	rm/sm CU	se	TL	Cu	Al	ld./Cu	ld./Al	kg/100	PU
293578	25	16	35	61	5,5	7,6	8	12	1,600	10
293582	35	16	50	71	5,5	8,0	8	14	2,100	10
293584		25		71	7,0	8,0	10	14	2,500	10
293598	50	25	70	71,5	7,0	9,8	10	16	3,100	10
293600		35		71,5	8,2	9,8	12	16	3,300	10
293606	70	25	95	79	7,0	11,2	10	18	4,400	10
293608		35		79	8,2	11,2	12	18	5,500	10
293610		50		85	10,0	11,2	14	18	5,700	10
293622	95	35	120	79	8,2	13,2	12	22	6,000	5
293624		50		85	10,0	13,2	14	22	8,900	5
293626		70		87	11,5	13,2	16	22	8,200	5
293634	120	50	150	87	10,0	14,7	14	22	7,900	5
293636		70		89	11,5	14,7	16	22	9,500	5
293638		95		97	13,5	14,7	18	22	10,000	5
293652	150	95	185	107,5	13,5	16,3	18	25	11,700	5
293654		120		107,5	15,5	16,3	20	25	14,200	5
293656		150		124,0	17,5	16,3	22	25	16,700	5
293664	185	120	240	108	15,5	18,3	20	28	16,930	5
293666		150		113	17,0	18,3	22	28	19,500	5
293678	240	150	300	124	17,0	21,0	22	32	23,300	5
293680		185		127	19,0	21,0	25	32	25,500	5
293688	300	185	400	128	18,5	19,0	25	34	32,700	5
293690		240		128	21,5	23,5	28	34	37,500	5

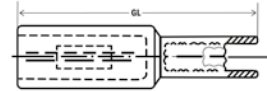

Cupal washer

- Compound material made from aluminium and copper
- Galvanic isolation between Cu and Al
- Processing only in a dry environment
- Al-sided plated with Cu

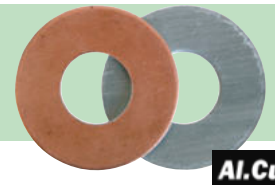

Al.Cu

Art. no.	M	s1	d2	Ø	kg/100	PU
293810	10	1,5	10,5	22	0,260	50
293812	12	2	13,0	28	0,440	50
293814	14	2	14,6	28	0,400	50
293816	16	2	16,5	35	0,660	50

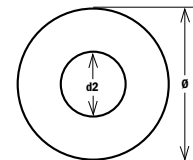

Screw terminals



Screw terminals 10 - 30 KV

AL screw terminals medium voltage 10-30 KV

- Material: AL 99,5%
- for tension relief connections of Al medium-voltage cables
- Tin-plated surface



AL

Art. no.	CSS	M	d1	d4	A	TL	⊙	kg/100	PU
293140	16 - 95	12	12,5	24,0	32,0	60	1	6,400	1
293142	50 - 150	12	15,5	30,0	35,0	79	1	13,900	1
293144		16	15,5	30,0	35,0	79	1	14,500	1
293146	95 - 240	12	20,0	33,0	56,0	95	2	23,700	1
293148		16	20,0	33,0	56,0	95	2	24,400	1
293150	120 - 300	12	25,0	38,0	67,0	100	2	33,300	1
293152		16	25,0	38,0	67,0	100	2	32,700	1
293154	185 - 400	12	26,0	42,0	82,0	115	3	48,000	1
293156		16	26,0	42,0	82,0	115	3	48,200	1

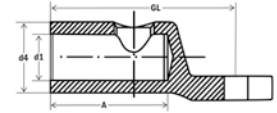

AL screw connectors medium voltage

- Material: AL 99,5%
- Screws: Tin-galvanised brass
- Tin-plated surface

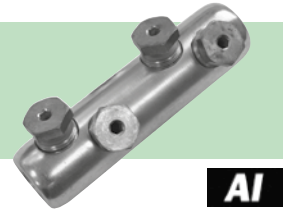

AL

Art. no.	CSS	d1	d4	TL	⊙	kg/100	PU
293130	16 - 95	12,5	24,0	70	2	9,800	1
293132	50 - 150	15,5	30,0	85	2	17,700	1
293134	95 - 240	20,0	33,0	120	4	33,500	1
293136	120 - 300	25,0	38,0	142	4	49,000	1
293138	185 - 400	26,0	42,0	170	6	78,900	1

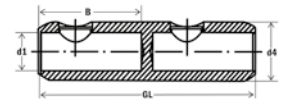

		CSS					
		AL			CU		
Terminals	rm	re	sm	rm	sm	⊙	
		16 - 95	16.50/95	25 - 70	16 - 95	25 - 70	1
	50 - 150	50 - 150	50 - 120	35 - 120	50 - 120	1	
	95 - 240	95 - 240	95 - 185	95 - 240	95 - 185	2	
	120 - 300	120 - 300	120 - 240	120 - 300	120 - 240	2	
	155 - 400	185 - 240/400	185 - 300	185 - 300	185 - 300	3	
Connectors							
		16 - 95	16.50/95	25 - 70	16 - 95	25 - 70	2
		50 - 150	50 - 150	50 - 120	35 - 120	50 - 120	2
		95 - 240	95 - 240	95 - 185	95 - 240	95 - 185	4
		120 - 300	120 - 300	120 - 240	120 - 300	120 - 240	4
		155 - 400	185 - 240/400	185 - 300	185 - 300	185 - 300	6

Advantages of the tear-off screw

- simple assembly
- the screw head shears off when clamping torque is right
- no torque key required
- screw can be detached using the hexagon socket

1. The screw is fitted with several tear-off spots, with different shear-off torque, a hexagon head and socket.

2. The tear-off torques are defined in such a way that generally the biggest conductor cross-section is clamped with the biggest clamping torque and the smaller conductor cross-section with the smaller clamping torque. This happens by allocating hexagon head and socket.

3. Assembly is much simpler than with the telescopic screw, because each screw needs to be pulled and torn off only once.

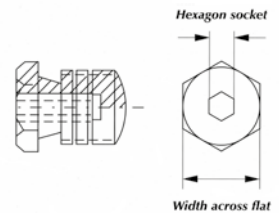

Screw lugs and connectors

Screw connectors are a reliable and economic way of connecting identical or different conductor cross-sections. They can be used up to 36kV. All lugs and connectors are fitted with torque-limited shear-off screws.

The actual cross-section of the cable does not need to be known, because each screw lug or connector covers many cable sizes. This results in simplified logistics, a small stock of lugs will cover a wide range of applications.

Also, the tin-plated surface means that they can be used on both copper and aluminium cables.

The principle of multiple tear-off screws

The screws of the Haupa screw lugs and connectors have a hexagon head and socket, which clamps the conductor cross-section with optimal clamping torque and therefore reduces assembly time.

As the screw is tightened it will shear off when correct torque is reached and a good joint is made.



Tubular cable lugs assortment standard

Content: 380 crimping terminals, crimping pliers (art. 210805), crimp standard 6 - 50 mm², hexagon crimping, in plastic bulk storage chest 415 x 335 x 90 mm.

- 50 crimping terminal, 6, M6, art. 290934
- 50 crimping terminal, 6, M8, art. 290936
- 50 crimping terminal, 10, M6, art. 290940
- 50 crimping terminal, 10, M8, art. 290942
- 30 crimping terminal, 16, M8, art. 290952
- 40 crimping terminal, 16, M10, art. 290954
- 25 crimping terminal, 25, M8, art. 290960
- 25 crimping terminal, 25, M10, art. 290962
- 20 crimping terminal, 35, M8, art. 290968
- 20 crimping terminal, 35, M10, art. 290970
- 20 crimping terminal, 50, M8, art. 290978



Art. no.	Content	type	kg	PU
290380	380	standard	6,000	1

Tubular cable lugs assortment DIN 46235

Content: 380 crimping terminals crimping pliers (art. 210805K), crimp DIN 6 - 50 mm², hexagon crimping, in plastic bulk storage chest 415 x 335 x 90 mm.

- 50 Crimping terminal DIN 46235, 6, M6, art. 290404
- 50 Crimping terminal DIN 46235, 6, M8, art. 290406
- 50 Crimping terminal DIN 46235, 10, M6, art. 290410
- 50 Crimping terminal DIN 46235, 10, M8, art. 290412
- 30 Crimping terminal DIN 46235, 16, M8, art. 290418
- 40 Crimping terminal DIN 46235, 16, M10, art. 290420
- 25 Crimping terminal DIN 46235, 25, M8, art. 290426
- 25 Crimping terminal DIN 46235, 25, M10, art. 290428
- 20 Crimping terminal DIN 46235, 35, M8, art. 290434
- 20 Crimping terminal DIN 46235, 35, M10, art. 290436
- 20 Crimping terminal DIN 46235, 50, M8, art. 290440



Art. no.	Content	type	kg	PU
290382	380	DIN	6,600	1

SysCon cable lugs DIN & 210805 K SysCon

Content: 380 cable lugs DIN 46235, tinned

1	220370	ABS plastic box „SysCon S”		
2	220376	Foam „SysCon” 400 x 300 x 15 mm		
1	500270	Foam for sets 160 x 400 mm		
1	210805 K	Crimping pliers hexagonal crimping 6 – 50 mm ²		
50	290404	Cable lugs DIN	6	M6
50	290406	Cable lugs DIN	6	M8
50	290410	Cable lugs DIN	10	M6
50	290412	Cable lugs DIN	10	M8
30	290418	Cable lugs DIN	16	M8
40	290420	Cable lugs DIN	16	M10
25	290426	Cable lugs DIN	25	M8
25	290428	Cable lugs DIN	25	M10
20	290434	Cable lugs DIN	35	M8
20	290436	Cable lugs DIN	35	M10
20	290440	Cable lugs DIN	50	M8

SysCon cable lugs standard & 210805 SysCon

Content: 380 cable lugse standard, tinned

1	220370	ABS plastic box „SysCon S”		
2	220376	Foam „SysCon” 400 x 300 x 15 mm		
1	500270	Foam for sets 160 x 400 mm		
1	210805	Crimping plier hexagonal crimping 6 – 50 mm ²		
50	290934	Cable lugs standard	6	M6
50	290936	Cable lugs standard	6	M8
50	290940	Cable lugs standard	10	M6
50	290942	Cable lugs standard	10	M8
30	290952	Cable lugs standard	16	M8
40	290954	Cable lugs standard	16	M10
25	290960	Cable lugs standard	25	M8
25	290962	Cable lugs standard	25	M10
20	290968	Cable lugs standard	35	M8
20	290970	Cable lugs standard	35	M10
20	290978	Cable lugs standard	50	M8



Art. no.	Content	type	kg	PU
220385	380	DIN	4,300	1

Art. no.	Content	type	kg	PU
220386	380	standard	4,300	1

SysCon cable lugs DIN 46235



Content: 389 cable lugs DIN, tinned

- 1 220370 ABS plastic box „SysCon S”
- 2 220376 Foam „SysCon” 400 x 300 x 15 mm

100	290404	Cable lugs DIN	6	M6
100	290412	Cable lugs DIN	10	M8
50	290418	Cable lugs DIN	16	M8
50	290426	Cable lugs DIN	25	M8
25	290434	Cable lugs DIN	35	M8
18	290442	Cable lugs DIN	50	M10
12	290450	Cable lugs DIN	70	M10
10	290458	Cable lugs DIN	95	M12
12	290464	Cable lugs DIN	120	M12
4	290472	Cable lugs DIN	150	M12
4	290480	Cable lugs DIN	185	M12
4	290486	Cable lugs DIN	240	M12

SysCon cable lugs standard



Content: 389 cable lugs standard

- 1 220370 ABS plastic box „SysCon S”
- 2 220376 Foam „SysCon” 400 x 300 x 15 mm

100	290934	Cable lugs standard	6	M6
100	290942	Cable lugs standard	10	M8
50	290952	Cable lugs standard	16	M8
50	290960	Cable lugs standard	25	M8
25	290968	Cable lugs standard	35	M8
18	290980	Cable lugs standard	50	M10
12	290988	Cable lugs standard	70	M10
10	290998	Cable lugs standard	95	M12
12	290008	Cable lugs standard	120	M12
4	290016	Cable lugs standard	150	M12
4	290022	Cable lugs standard	185	M12
4	290028	Cable lugs standard	240	M12



Art. no.	Content	type	kg	PU
220387	389	DIN	4,300	1

Art. no.	Content	type	kg	PU
220388	389	standard	4,300	1



Cable ties, accessories



INFO

Cable ties

HAUPA cable ties are characterised by their tightness, high tensile strength of the loop and extreme flexibility of the cord.

As a result of these characteristics, HAUPA cable ties are able to cope with even the most extreme installation practices, which conventional cable ties would not be able to cope with. All HAUPA cable ties conform to WEEE/RoHS guidelines.

The cable ties product range includes:

- **cable ties**
colour: transparent/black
- **cable ties**
colour: black (UV-resistant)
- **releasable ties**
colour: black
- **double-locking cable ties**
colour: black
- **cable ties with fixing eye**
colour: transparent
- **cable ties with label**
colour: transparent
- **hook and loop ties**
colour: black, green

Accessories:

- adhesive base, screw base, plug mount base

Ideal storage conditions for cable ties made from nylon

Cable ties are made from high-quality nylon. This technical plastic is usually processed through injection moulding, but it can also be extruded. Nylon is a hygroscopic plastic that absorbs water and can release it. In order to process the ties optimally, it is important that the material is in a balanced state with a water content of approx. 2.5%. The original HAUPA cable tie packaging provides constant water content in the material.

The cable ties should be stored as follows:



Storage in a closed plastic bag made from polyethylene



No direct sunlight



Storage without direct exposure to heat (radiator etc.)



Ideal storage temperature (standard Central European climatic conditions) up to 23° with 50% humidity 23°C

All HAUPA cable ties are made from plastic and are recyclable. The internal toothing of the ties gives you the necessary strength to tie the material. The cable ties can be simply used by hand or with a HAUPA cable tie tool. The slightly bent end allows the tie to be inserted into the head easily.

Use: For bundling and fastening cables, wires and tubes. NH (non-halogen) – RoHS conform

Cable ties

material: nylon, colour transparent, quick and simple to fix by hand or with tensioning tools, extremely resistant to sea water, oil, grease, etc., manufactured in accordance with UL and MIL specification requirements, - 40° C to 85° C



Art. no.	TL	width			kg/100	PU	PE	
262500/1	75	2,4	15	8	0,035	100	100	30.000
262500	96	2,5	23	8	0,028	100	100	30.000
262502	*	100	2,5	25	8	0,030	100	25.000
262504	*	142	2,5	35	8	0,044	100	25.000
262506	*	203	2,5	55	8	0,065	100	13.000
262508	*	142	3,2	35	18	0,083	100	10.000
262509/1	203	3,6	53	18	0,100	100	100	10.000
262510/1	250	3,6	68	18	0,150	100	100	6.000
262510	*	292	3,6	85	18	0,155	100	7.000
262512/1	120	4,8	27	22	0,080	100	100	10.000
262515	157	4,8	40	22	0,040	100	100	6.000
262512	*	188	4,8	54	22	0,143	100	8.000
262516	*	199	4,8	52	22	0,145	100	7.000
262518	*	250	4,8	74	22	0,203	100	6.000
262511/1	290	4,8	81	22	0,210	100	100	5.000
262520	*	302	4,8	84	22	0,220	100	5.000
262522	*	371	4,8	102	22	0,274	100	4.000
262523	430	4,8	125	22	0,290	100	100	4.000
262528	200	7,6	54	55	0,300	100	100	2.000
262530	290	7,6	82	55	0,400	100	100	2.000
262532	*	370	7,6	101	54	0,540	100	2.500
262534	450	7,6	130	55	0,800	50	100	1.000
262534/1	540	7,6	160	55	0,820	50	100	1.000
262536	*	425	8,8	115	80	0,760	50	500
262537	523	8,8	150	80	0,105	50	100	500
262538	610	8,8	180	80	1,270	50	100	500
262535	774	8,8	220	80	1,050	50	100	600
262540	800	8,8	235	80	1,600	20	100	500
262542	920	8,8	278	80	0,860	50	100	500
262543	1219	9,0	374	80	1,100	20	100	500
262545	246	12,4	64	114	0,860	50	100	500
262546	550	12,7	166	114	1,770	50	100	500
262547	1030	12,7	312	114	3,200	20	100	500



Cable ties

material: nylon - colour black, all other data and properties like No. 262500 - 46, weather- and UV-resistant



Art. no.	TL	width	↓	■	kg/100	PU	PE	
262600/1	75	2,4	15	8	0,035	100	100	30.000
262600	96	2,5	23	8	0,040	100	100	30.000
262602 *	100	2,5	25	8	0,040	100	100	25.000
262604 *	142	2,5	35	8	0,040	100	100	20.000
262606 *	x203	2,5	55	8	0,080	100	100	10.000
262608 *	142	3,2	35	18	0,080	100	100	10.000
262609/1	203	3,6	53	18	0,100	100	100	10.000
262610/1	250	3,6	68	18	0,150	100	100	6.000
262610 *	292	3,6	85	18	0,160	100	100	7.000
262611/1	372	3,6	106	18	0,170	1000	100	4.000
262616 *	203	4,6	52	22	0,150	100	100	6.000
262612/1	120	4,8	27	22	0,080	100	100	10.000
262615	157	4,8	40	22	0,100	100	100	6.000
262618 *	250	4,8	74	22	0,200	100	100	6.000
262620 *	302	4,8	84	22	0,240	100	100	5.000
262622 *	371	4,8	102	22	0,270	100	100	4.000
262623	430	4,8	125	22	0,290	100	100	4.000
262628	200	7,6	54	55	0,300	100	100	2.000
262630	290	7,6	82	55	0,400	100	100	2.000
262632 *	370	7,6	101	54	0,540	100	100	2.500
262634	450	7,6	130	55	0,800	50	100	1.000
262634/1	540	7,6	160	55	0,820	50	100	1.000
262636 *	425	8,8	115	80	0,880	50	100	500
262637	523	8,8	150	80	1,050	50	100	500
262638	610	8,8	180	80	1,280	50	100	500
262635	774	8,8	220	80	1,050	50	100	600
262640	800	8,8	235	80	1,600	20	100	500
262642	920	8,8	278	80	0,880	50	100	500
262643	1219	8,8	374	80	1,100	20	100	500
262645	246	12,4	64	114	0,860	50	100	500
262646	550	12,7	166	114	1,600	50	100	500
262647	1030	12,7	312	114	3,200	20	100	500

Cable ties

material: polyamide 6,6 - colour transparent, resistant to mildew and rotting, extremely resistant to sea water, oil, grease, hydrocarbons and hydraulic fluids, operating temperature: -40° to +85° C, these binders meet the requirements of the military specification Mil.-Spec. 23 190C (WEP) MS-3367



Art. no.	TL	width	↓	■	kg/100	PU	PE	
262100	100	2,5	23	8	0,031	100	100	25.000
262102	142	3,2	35	18	0,074	100	100	10.000
262101	203	3,6	55	18	0,131	100	100	10.000
262106	203	4,6	55	22	0,150	100	100	7.000
262108	310	4,8	89	22	0,228	100	100	5.000
262110	368	4,8	102	22	0,227	100	100	4.000
262114	380	7,6	110	55	0,560	50	100	2.000
262116	550	12,7	166	114	1,600	50	100	500

Cable ties

material: polyamide 6,6 - colour black, all other data and properties like No. 262100 - 16, resistant to sea water, oil, grease, etc., not UV-resistant



Art. no.	TL	width	↓	■	kg/100	PU	PE	
262120	100	2,5	25	8	0,003	100	100	25.000
262122	142	3,2	35	18	0,065	100	100	10.000
262124	203	3,6	55	18	0,116	100	100	10.000
262126	199	4,8	54	22	0,145	100	100	6.000
262128	302	4,8	84	22	0,248	100	100	5.000
262130	368	4,8	102	22	0,269	100	100	4.000
262132	290	7,6	82	55	0,397	100	100	2.000
262134	370	7,6	106	55	0,580	50	100	2.000
262136	618	12,4	181	114	1,600	50	100	500

Cable ties "UVplus"



Long-term weather resistant, for industrial uses, black, UV resistant, material - polyamide, **7 year guarantee**



Art. no.	TL	width	↓	■	kg/100	PU	PE	
262950	100	2,5	25	8	0,030	100	100	
262952	202	2,5	50	8	0,070	100	100	
262954	150	3,3	38	13	0,070	100	100	
262956	201	3,6	52	13	0,150	100	100	
262958	290	3,6	82	18	0,160	100	100	
262960	199	4,8	50	22	0,150	100	100	
262962	250	4,8	72	22	0,200	100	100	
262964	290	4,8	83	22	0,220	100	100	
262966	371	4,8	106	22	0,270	100	100	
262968	290	7,6	82	54	0,410	100	100	
262970	370	7,6	108	54	0,550	100	100	
262972	542	7,6	162	54	0,750	100	100	
262974	523	8,8	156	79	1,000	50	100	
262976	709	8,8	213	79	1,000	50	100	
262978	774	8,8	220	79	1,000	50	100	
262980	920	8,8	279	79	1,000	50	100	

Cable ties

material: nylon - colour transparent, all other data and properties like No. 262500 - 46, big packing unit 1000 pcs.



Art. no.	TL	width	↓	■	kg/100	PU	PE	
262501	96	2,5	23	8	0,028	1000	100	
262503	100	2,5	25	8	0,026	1000	100	
262505	142	2,5	35	8	0,031	1000	100	
262507	203	2,5	55	8	0,065	1000	100	
262509	142	3,2	35	18	0,070	1000	100	
262511	290	3,6	82	18	0,158	1000	100	
262513	188	4,8	54	22	0,140	1000	100	
262517	199	4,8	54	22	0,140	1000	100	

Heat-resistant cable ties

Material nylon 6/6, colour light green, UL94V-2, for high temperature applications between -40°C and +105°C



Art. no.	TL	width	†	■	■	kg/100	PU	PE
263000	100	2,5	21	8		0,030	100	100
263004	200	2,5	21	8		0,065	100	100
263006	120	3,6	37	18		0,039	100	100
263008	160	4,6	40	22		0,082	100	100
263010	199	4,6	40	22		0,134	100	100
263012	371	4,6	106	22		0,260	100	100

“UV” heat-resistant cable ties, black

Material nylon 6/6, colour black, UL94V-2, for high temperature applications between -40°C and +145°C, UV-stabilized

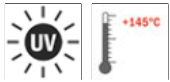

Art. no.	TL	width	†	■	■	kg/100	PU	PE
263022	161	2,5	21	8		0,045	100	100
263024	200	2,5	21	8		0,065	100	100
263026	199	4,6	54	22		0,130	100	100
263028	302	4,6	84	22		0,188	100	100
263030	370	7,6	106	54		0,494	100	100

Flame retardant cable ties

Material nylon 6/6, colour ivory, UL94V-0, for use in temperatures between -40°C and +85°C



Art. no.	TL	width	†	■	■	kg/100	PU	PE
263050	80	2,5	21	8		0,030	100	100
263056	140	3,6	38	18		0,079	100	100
263064	385	4,6	106	22		0,263	100	100
263058	160	4,8	54	22		0,103	100	100
263066	290	7,6	106	54		0,392	100	100

HUPimpact cable ties



Material shock-resistant nylon 6/6, colour black, UL 94HB, for use in temperatures between -40°C and +80°C, extremely high flexibility in cold environments



Art. no.	TL	width	†	■	■	kg/100	PU	PE
263100	199	4,6	54	22		0,131	100	100
263102	288	4,6	81	22		0,177	100	100
263104	302	4,6	84	22		0,251	100	100
263106	371	4,6	106	22		0,273	100	100
263108	290	7,5	82	54		0,249	100	100
263110	370	7,5	106	54		0,524	100	100
263112	774	8,7	220	79		0,102	100	100

HUPsecure cable ties

Material PP, colour: yellow, can be used as a seal /connector



Art. no.	TL	width	†	■	■	kg/100	PU	PE
263200	245	3,6	43			0,434	100	100
263204	295	3,6	60			0,491	100	100
263208	397	3,6	92			0,537	100	100

Releasable cable ties for frequent opening and closing

for temporary wiring and sub-assembly, material: polyamide 6,6 - colour black, operation temperature: -40° to +85° C, UL E 341152



Art. no.	TL	width	∅	■	□	kg/100	PU	PE
262140	150	7,6	33	22		0,201	100	100
262142	200	7,6	33	22		0,249	100	100
262144	300	7,6	80	22		0,349	100	100

Double-locking-cable ties

material: nylon - colour black, (262710 Nylon 12).

Benefits:

- Flat head geometry
- Exterior
- Smooth side is up against the insulation - no dents or damages
- Wide contact surface protects the cable loom from damages

Application:

- Bundling of tubes in narrow shafts
- Cable bundling in hollow wall spaces
- Pull-out forces are well distributed thanks to the extra-wide tie



Art. no.	TL	width	∅	■	□	kg/100	PU	PE
262700	180	9,0	45	55		0,319	100	100
262702	300	9,0	88	55		0,512	100	100
262704	360	9,0	100	55		0,629	100	100
262710	300	9,0	88	55		0,463	100	100

Cable ties with fixing eye

material: nylon, colour transparent, quick and simple to fix by hand or with tensioning tools, extremely resistant to sea water, oil, grease, etc., manufactured in accordance with UL and MIL specification requirements, - 40° C bis 85° C

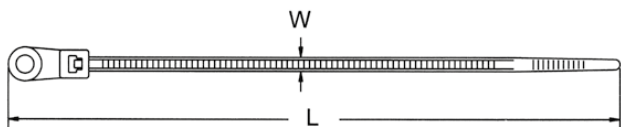

Art. no.	TL	width	∅	■	□	kg/100	PU	PE
262820	100	2,5	3,0	25	8	0,044	100	100
262822	170	3,7	4,8	40	18	0,100	100	100
262824	170	3,7	4,0	40	18	0,105	100	100
262826 *	205	4,2	4,6	60	22	0,133	100	100
262828 *	300	4,8	4,8	85	22	0,224	100	100
262830	300	7,8	6,0	80	55	0,443	100	100
262832	370	4,8	4,9	102	22	0,276	100	100
262834	398	7,9	6,1	122	55	0,595	100	100

Cable ties with marking space

These cable ties are suitable for simple labelling and simultaneous bundling of cable loops. This saves one work step. Material: nylon, colour natural, can be fastened quickly and easily using a tool or by hand. Extremely resistant to sea water, oil, fats etc, manufactured according to UL gema tested nylon. Technical data: material polyamide 6.6 (N66), operating temperature -40 to +85 C.

Group features: HF (non-halogen), RoHS-conform

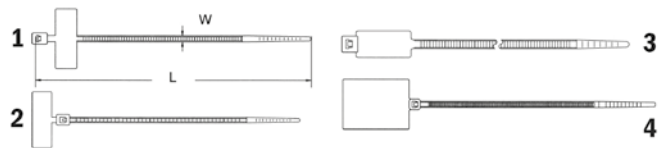

Art. no.	TL	width	label	∅	■	□	kg/100	PU	PE
262840 *	1	100	2,5	25 x 8	25	8	0,049	100	100
262842 *	4	130	2,5	28 x 20	25	8	0,093	100	100
262844	2	110	2,5	25 x 8	25	8	0,058	100	100
262846	3	200	4,6	28 x 13	50	22	0,147	100	100
262848 *	1	200	2,5	30 x 15	50	8	0,128	100	100
262850	3	270	4,6	28 x 13	75	22	0,198	100	100

Identification label for cable ties / marking cables

Material PE, for marking cables, pipes and lines, low weight, permanent labelling

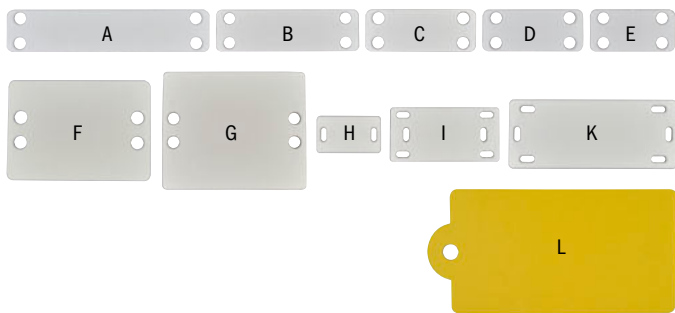

Art. no.	TL	W	H	kg/100	PU	PE	
262179	26,0	15,0	1,2	0,048	100	100	H
262180	42,2	21,0	1,2	0,107	100	100	I
262181	60,8	25,0	1,2	0,201	100	100	K
262182	62,2	51,0	1,3	0,456	100	100	G
262183	38,5	19,0	0,4	0,036	100	100	E
262184	45,3	19,0	0,4	0,043	100	100	D
262185	50,5	19,1	0,4	0,053	100	100	C
262186	65,0	19,1	0,4	0,064	100	100	B
262187	63,8	44,8	0,4	0,167	100	100	F
262188	90,0	19,1	0,4	0,096	100	100	A
262189	160	80,0	0,6	1,106	100	100	L

Labelling box

Material PE, for attaching using cable ties (widths up to 4.8mm)

Instructions: Open box, insert labelled paper, snap box shut and attach using cable ties



Art. no.	TL	W	H	kg/100	PU	PE	
262190	11,5	32,6	3,0	0,087	100	100	1
262191	19,1	43,5	4,6	0,257	100	100	2

Self adhesive sockets

for cable ties and a quick and reliable fastening of line or cable bundles and other objects



Art. no.	TL		width	kg/100	PU	PE
262160 *	19	natural	3,6	19	0,078	100
262161	19	black	3,6	19	0,075	100
262162 *	28	natural	4,8	28	0,178	100
262163	28	black	4,8	28	0,190	100

Screw type sockets

for cable ties and a quick and reliable fastening of large diam. Cable bundles and other objects, not UV-resistant



Art. no.	TL		width	kg/100	PU	PE
262164 *	1,5	natural	7,8	1	0,121	100
262165 *	1,5	black	7,8	1	0,136	100

Dowel Mounting sockets/Christmas trees

for cable ties up to a width of 9 mm, 2 types with different wall-distances, available wall-fixing avoid the friction of the cable on the wall, black colour

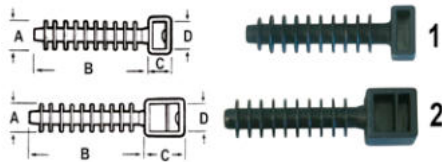

Art. no.	TL		width	C	D	PU	PE
262170 *	37	9	10	1	6,5	9,2	100
262172	37	9	10	2	13	9,2	100

Tensioning tools for cable ties

Prevents overstretching and constriction by continuously adjustable stress limitation. The built-in knife will cut only, when the requested tension has been reached



Art. no.	width	material	kg	PU
262153	2,5-5	metal	0,330	1

Tensioning tools for cable ties

Prevents overstretching and constriction by continuously adjustable stress limitation. The built-in knife will cut only, when the requested tension has been reached



Art. no.	width	material	kg	PU
262151	2,5-5	plastic	0,240	1

Tensioning tools for cable ties

Prevents overstretching and constriction by continuously adjustable stress limitation. The built-in knife will cut only, when the requested tension has been reached



Art. no.	width	material	kg	PU
262152	2,5-5	metal	0,334	1

Tensioning tools for cable ties

Prevents overstretching and constriction by continuously adjustable stress limitation. The built-in knife will cut only, when the requested tension has been reached



Art. no.	width	material	kg	PU
262154	2,5-13	metal	0,365	1

Tensioning tools for cable ties

Prevents overstretching and constriction by continuously adjustable stress limitation. The built-in knife will cut only, when the requested tension has been reached



Art. no.	width	material	kg	PU
262158	2,5-10	metal	0,303	1



Spiral bindings

Hook-and-loop cable ties

made from extruded polyamide-velour laminate, thickness approx. 1.4 mm, selfadhesive back to back, suitable for approx. 200 uses. Colours: black and green Hook-and-loop cable ties with loop, cut to binder measurements for all standard electrical installations



pieces

Art. no.	TL	width	kg/100	PU	PE
262750	125	black 12	0,220	20	100
262752	135	black 12	0,240	20	100
262754	180	black 12	0,300	20	100
262756	210	black 16	0,420	20	100
262758	310	black 16	0,560	20	100
262760	125	green 12	0,220	20	100
262762	135	green 12	0,230	20	100
262764	180	green 12	0,300	20	100
262766	210	green 16	0,430	20	100
262768	310	green 16	0,610	20	100

Hook-and-loop cable ties

coil



Art. no.	TL	width	kg/100	PU	PE
262782	10000	20	10,000	1	1

Cable ties, accessories

Polyethene spiral binding

natural, non-flame resistant



Art. no.	TL	∅	>∅	kg	PU
262060	30	1,5	10	0,141	1
262062 *	30	4	25	0,390	1
262064 *	30	9	32	0,780	1

Polyethene spiral binding

white, nearly flame resistant



Art. no.	TL	∅	>∅	kg	PU
262066	30	1,5	10	0,156	1
262068 *	30	4	25	0,497	1
262069	30	9	32	0,964	1

Polyethene spiral binding

white, nearly flame resistant



Art. no.	TL	∅	>∅	kg	PU
262030	2	8	18	0,156	1
262031	2	15	31	0,156	1
262032	2	20	43	0,156	1
262033	2	25	54	0,156	1

Polyethene spiral binding

white, nearly flame resistant



Art. no.	TL	∅	>∅	kg	PU
262034	2	8	18	0,156	1
262035	2	15	31	0,156	1
262036	2	20	43	0,156	1
262037	2	25	54	0,156	1



Steel cable ties, accessories



Steel cable ties, SS 316 (V4A) with ball closure

made from stainless steel 316 (DIN 1.4401), corrosion and radiation resistant, non-magnetic, extremely resistant to high temperatures (steel -80 °C to +538 °C) and aggressive chemicals, steel thickness 0.3 mm.

For use in machinery, vehicles, signalling, shipping and mining, in the food and chemical industries, in power plants, underground systems, on drilling platforms, wind-power generation plants and telecommunications, radio technology, stage construction, trade fair construction.



Art. no.	TL	width	h	■	■	kg/100	PU	PE
262940/125 *	125	4,5	22	45		0,400	100	100
262940/152 *	152	4,5	25	45		0,230	100	100
262940/200 *	200	4,5	50	45		0,280	100	100
262940/250 *	250	4,5	65	45		0,330	100	100
262940/300 *	300	4,5	75	45		0,420	100	100
262940/360 *	360	4,5	102	45		0,450	100	100
262940/520 *	520	4,5	152	45		0,660	25	100
262950/152	152	8,0	25	113		0,480	100	100
262950/200	200	8,0	50	113		0,680	100	100
262950/300	300	8,0	75	113		0,750	100	100
262950/360	360	8,0	102	113		0,920	100	100
262950/520	520	8,0	152	113		1,280	25	100
262950/680	680	8,0	203	113		1,550	25	100
262950/840	840	8,0	254	113		1,840	25	100
262950/1050	1050	8,0	318	113		2,560	25	100
262960/290	290	12,0	80	272		1,500	100	100
262960/360	360	12,0	102	272		1,700	100	100
262960/520	520	12,0	152	272		2,800	25	100
262960/680	680	12,0	203	272		3,300	25	100
262960/840	840	12,0	254	272		4,500	25	100
262960/1000	1000	12,0	302	272		5,000	25	100
262960/1200	1200	12,0	351	272		5,500	25	100

Steel cable ties, SS 316 (V4A) with ball closure

with cable protection sleeve made of epoxy resin polyester, free from halogen, black made from stainless steel 316 (DIN 1.4401), corrosion and radiation resistant, non-magnetic, extremely resistant to high temperatures (steel -80 °C to +538 °C) and aggressive chemicals, steel thickness 0.3 mm.

For use in machinery, vehicles, signalling, shipping and mining, in the food and chemical industries, in power plants, underground systems, on drilling platforms, wind-power generation plants and telecommunications, radio technology, stage construction, trade fair construction.

Benefits:

- Soft edges
- Easy installation comfort and handling
- Fully coated to prevent contact corrosion
- Gentle fixture

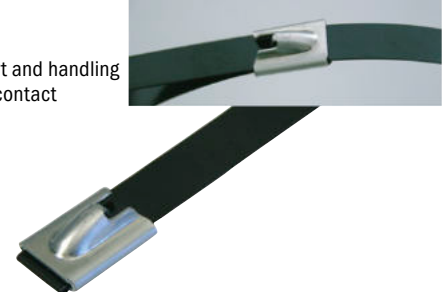

Art. no.	TL	width	h	■	■	kg/100	PU	PE
262942/125	125	4,5	22	45		0,190	100	100
262942/152	152	4,5	25	45		0,230	100	100
262942/200	200	4,5	50	45		0,280	100	100
262942/250	250	4,5	60	45		0,330	100	100
262942/300	300	4,5	75	45		0,420	100	100
262942/360	360	4,5	102	45		0,450	100	100
262942/520	520	4,5	152	45		0,660	25	100
262952/152	152	8,0	25	113		0,480	100	100
262952/200	200	8,0	50	113		0,680	100	100
262952/300	300	8,0	75	113		0,750	100	100
262952/360	360	8,0	102	113		0,920	100	100
262952/520	520	8,0	152	113		1,280	25	100
262952/680	680	8,0	203	113		1,550	25	100
262952/840	840	8,0	254	113		1,840	25	100
262952/1050	1050	8,0	318	113		2,560	25	100
262962/290	290	12,0	80	272		1,500	100	100
262962/360	360	12,0	102	272		1,700	100	100
262962/520	520	12,0	152	272		2,800	25	100
262962/680	680	12,0	203	272		3,300	25	100
262962/840	840	12,0	254	272		4,500	25	100
262962/1000	1000	12,0	302	272		5,000	25	100
262962/1200	1200	12,0	351	272		5,500	25	100

Steel cable ties, SS 316 (V4A) with ratchet function



made from stainless steel 316 (DIN 1.4401), corrosion and radiation resistant, non-magnetic, extremely resistant to high temperatures (steel -80 °C to +538 °C) and aggressive chemicals, steel thickness 0.3 mm; installation without additional tools.

For use in machinery, vehicles, signalling, shipping and mining, in the food and chemical industries, in power plants, underground systems, on drilling platforms, wind-power generation plants and telecommunications.



Art. no.	TL	width	h	kg/100	PU	PE
262970/1100	1100	10,0	330	5,500	10	100
262970/1315	1315	10,0	380	6,000	10	100

Tensioning tools for steel cable ties

Steel cable ties are tensioned by the tool and can be cut off flush. Cutting is implemented manually using a hand lever, the force cannot be pre-set. Only suitable for steel cable ties (coated and not coated).

Processing width: 4.5 - 12.0 mm, max. thickness of cable ties: 0.3 mm



Art. no.	width	material	kg	PU
262159	4.5 - 12.0	metal	0,560	1

Nailing clips

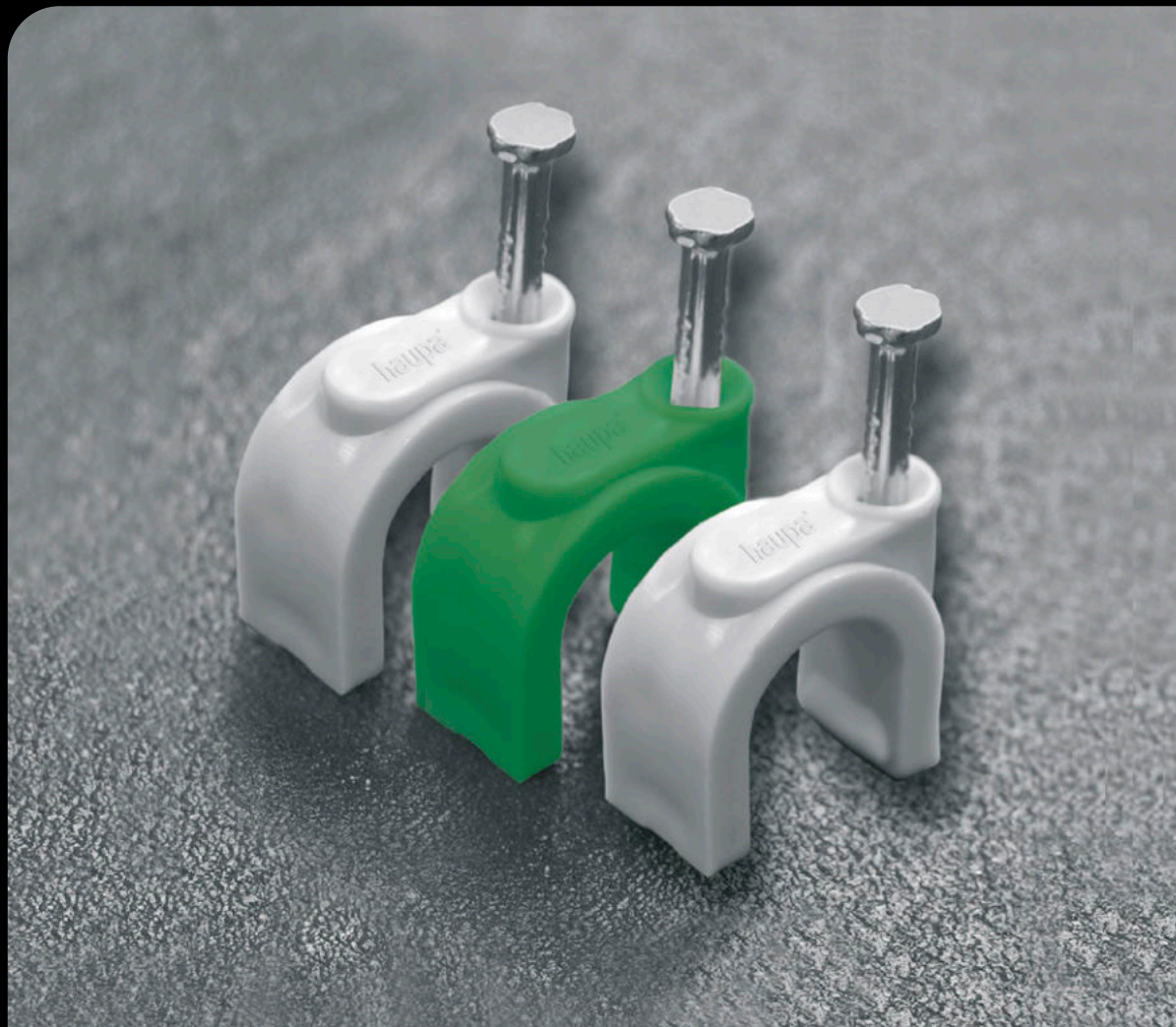

INFO

Nailing clips

Material: hammer-proof polyethylene (PE) halogen-free
 Temperature resistant: - 40 °C to + 80 °C, and for short periods up to approximately 100 °C



Nailing clips for round cable

for attaching and fixing electrical cables, optimum claw shape for secure fixing of the cable, can be fixed to the cable, version with inserted galvanised nail, material: hammer-proof polyethylene (PE), halogen-free, temperature resistant: - 40 °C to + 80 °C, and for short periods up to approximately 100 °C.

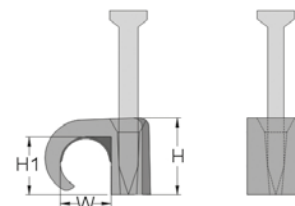

Art. no.	colour	∅	H	H1	W	NL	ND	kg/100	PU
262200	transparent	2-3	4,3	2,8	2,8	19	1,65	0,032	100
262202	transparent	3-5	5,6	3,7	2,9	15	2,0	0,038	100
262204	pure white	3-5	5,6	3,7	2,9	15	2,0	0,038	100
262206	black	5-7	8,0	6,0	5,3	20	2,0	0,100	100
262208	transparent	5-7	8,0	6,0	5,3	20	2,0	0,100	100
262209	light grey	5-7	8,0	6,0	5,3	35	2,0	0,100	100
262210 *	pure white	5-7	8,0	6,0	5,3	20	2,0	0,102	100
262212	black	7-10	9,5	7,1	6,8	25	2,0	0,093	100
262214	brown	7-10	9,5	7,1	6,8	25	2,0	0,092	100
262215	grey	7-10	9,5	7,1	6,8	35	2,0	0,092	100
262216	red	7-10	9,5	7,1	6,8	25	2,0	0,093	100
262218 *	pure white	7-10	9,5	7,1	6,8	25	2,0	0,092	100
262219	light grey	8 - 12	9,5	7,1	6,8	35	2,0	0,120	100
262220	black	10-14	13,0	10,3	9,4	35	2,0	0,166	100
262222 *	pure white	10-14	13,0	10,3	9,4	35	2,0	0,162	100
262223	light grey	10-14	13,0	10,3	9,4	44	2,0	0,162	100
262224	black	14-20	17,1	13,7	13,1	40	2,5	0,136	50
262226	pure white	14-20	17,1	13,7	13,1	40	2,5	0,138	50
262227	light-grey	14-20	17,1	13,7	13,1	44	2,5	0,138	50
262228	black	18-22	19,5	17,0	16,4	38	3,2	0,402	50
262230 *	pure white	18-22	19,5	17,0	16,4	38	3,2	0,396	50
262231	light grey	18 - 22	19,5	17	16,4	45	2,0	0,396	50
262232	black	22-26	21,0	19,5	24,0	38	3,2	0,464	50
262234	pure white	22-26	21,0	19,5	24,0	38	3,2	0,458	50
262235	light grey	22 - 26	21,0	19,5	24,0	38	3,2	0,458	50

Nailing clips for flat cable

for attaching and fixing electrical cables, optimum claw shape for secure fixing of the cable, can be fixed to the cable, version with inserted galvanised nail, material: hammer-proof polyethylene (PE), halogen-free, temperature resistant: - 40 °C to + 80 °C, and for short periods up to approximately 100 °C.



Art. no.	colour	∅	H	H1	W	NL	ND	kg/100	PU
262236	transparent	2-4	4,0	2,0	4,0	15	2,0	0,032	100
262238	transparent	3-5	5,2	3,3	4,6	15	2,0	0,038	100
262240	transparent	4-6	5,9	3,8	5,8	15	2,0	0,047	100
262242	light grey	5-8	7,5	4,9	7,9	25	2,0	0,107	100
262243	pure white	5-8	7,5	4,9	7,9	25	2,0	0,103	100
262244	light grey	6-10	8,2	5,8	9,8	25	2,0	0,120	100
262245	pure white	6-10	8,2	5,8	9,8	25	2,0	0,120	100
262246	light grey	7-14	9,3	6,5	11,8	25	2,0	0,176	100
262247	pure white	7-14	9,3	6,5	11,8	25	2,0	0,174	100
262248	light grey	9-18	12,2	9,4	16,7	22	2,5	0,237	100
262249	pure white	9-18	12,2	9,4	16,7	22	2,5	0,236	100

NL = nail length
 N-∅ = nail diameter
 H = height
 H1 = height 1
 W = width (opening)

Nailing clips

Nailing clips for round cable

for attaching and fixing electrical cables, version with inserted galvanised nail, material: hammer-proof polyethylene (PE), halogen-free, temperature resistant: - 40 °C to + 80 °C, and for short periods up to approximately 100 °C.

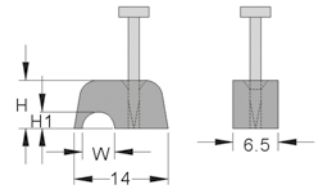

Art. no.	colour	Ø	W	NL	ND	kg/100	PU
262254	light grey	4,1	4,1	15	2,0	0,083	100
262256	light grey	4,1	4,1	20	2,0	0,089	100
262258	light grey	7,0	7,0	20	2,0	0,103	100
262260	light grey	9,0	9,0	20	2,0	0,178	100
262262	light grey	13,2	13,2	20	2,0	0,225	100

ISO nailing clips

for attaching and fixing electrical cables, can be fixed to the cable, version with inserted galvanised nail, material: hammer-proof polyethylene (PE), halogen-free, temperature resistant: - 40 °C to + 80 °C, and for short periods up to approximately 100 °C.

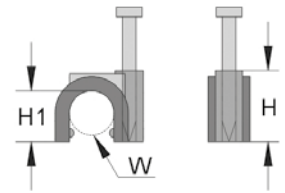

Art. no.	colour	Ø	H	H1	W	NL	ND	kg/100	PU
262264	light grey	2,75	4,5	2,6	2,75	20	2,0	0,083	100
262266	light grey	6,0	9,0	6,6	6,0	20	2,0	0,100	100
262268	light grey	8,0	12,9	9,0	8,0	25	2,0	0,131	100
262270	light grey	9,0	12,0	9,0	9,0	22	2,0	0,132	100
262272	light grey	10,0	13,8	10,4	9,3	25	2,0	0,145	100
262274	light grey	2,75	4,5	2,6	2,75	19	1,65	0,047	100
262276	light grey	3,5	5,9	3,7	3,5	15	2,0	0,060	100
262278	light grey	4,0	6,6	4,2	4,0	18	2,5	0,091	100
262280	light grey	5,0	7,6	5,0	5,0	18	2,5	0,100	100
262282	light grey	6,0	9,0	6,6	6,0	18	2,5	0,106	100
262284	light grey	6,0	10,5	6,9	6,0	20	2,5	0,119	100
262286	light grey	7,0	11,0	7,5	7,0	22	2,5	0,128	100
262288	light grey	8,0	12,9	8,15	8,0	22	2,5	0,136	100
262290	light grey	9,0	12,0	9,0	9,0	22	2,5	0,138	100
262292	light grey	9,5	13,8	10,4	9,3	25	2,5	0,156	100
262294	light grey	11,0	16,6	12,2	11,0	27	2,5	0,234	100
262296	light grey	12,0	16,0	12,3	12,0	27	2,5	0,223	100
262298	light grey	14,0	20,5	15,6	14,0	35	3,0	0,345	100
262300	light grey	16,0	21,7	17,0	16,5	38	3,2	0,472	100
262302	light grey	18,0	22,0	17,5	18,0	38	3,2	0,457	100
262304	light grey	20,0	23,5	18,5	20,0	38	3,2	0,254	50
262306	light grey	22,0	27,8	23,0	22,0	42	3,2	0,321	50
262308	light grey	25,0	30,4	25,0	25,0	47	3,2	0,433	50
262310	light grey	32,0	40,0	33,5	32,0	56	3,6	0,306	25

NL = nail length
 N-Ø = nail diameter
 H = height
 H1 = height 1
 W = width (opening)

haupa®

...convincing solutions

HAUPA GmbH & Co. KG, Koenigstr. 165-169, 42853 Remscheid, Phone: +49 (0)2191 8418-0, Fax: +49 (0)2191 8418-840, sales@haupa.com



Cable glands, IP68



Cable glands polyamide IP68

INFO

Cable glands polyamide IP68

Properties:

integrated strain relief, fully mounted, RoHS-compliant.

HAUPA cable glands do protect electric equipment (switchboards, distribution boxes) against mechanical influences, dust, and humidity by connecting a cable tight and sealed to the housing.

HAUPA offers next to metric as well PG cable glands.

HAUPA cable glands are IP68 (dust and humidity) to protect human against the potential risk during usage.

Cable glands IP 68, metric or PG, assembled with washer and lock nut, fully mounted

material: polyamide 6.6, (gland body: PA 6.6, halogen free, seal: TPR, halogen free, washer: PVC), colour: light-grey or black, temperature range: -40°C to +85°C, vibration protection: integrated anti-twist protection for vibration-firm assembly, fire class: according to UL 94 V-2, protection category: IP68, properties: integrated strain relief; easy to install, RoHS-compliant, completely assembled as shown

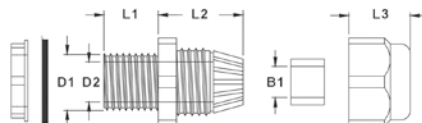

Art. no.	colour		KB	D1	D2	B1	L1	L2	L3	WS	kg/100	PU	
250040	light-grey	M12	3 - 6,5	12,0	8,3	6,9	7,9	19,6	13,6	15	0,024	10	4.250
250042	* light-grey	M16	5 - 10	16	10,9	9,6	15,5	23,4	16,9	22	0,024	10	1.700
250044	* light-grey	M20	8 - 12	20,0	14,1	12,5	10,0	25,0	18,1	24	0,024	10	1.200
250046	light-grey	M20	10 - 14	20,0	15,0	14,8	10,0	28,5	18,5	27	0,024	10	1.190
250048	light-grey	M20	10 - 14	20,0	15,0	14,8	15,0	28,5	18,5	27	0,024	10	1.190
250050	* light-grey	M25	13 - 18	25,0	18,6	18,4	15,2	29,4	22,3	33	0,024	10	680
250052	light-grey	M32	18 - 25	32,0	26,0	25,0	14,7	34,5	25,7	42	0,024	10	340
250054	light-grey	M40	22 - 32	40,0	33,7	33,1	18,4	41,7	31,3	54	0,024	5	230
250056	light-grey	M50	30 - 38	50,0	41,9	40,0	17,8	44,2	31,3	61	0,024	5	160
250058	light-grey	M63	34 - 44	61,0	55,0	43,2	18,5	44,6	32,7	66	0,024	5	120

Art. no.	colour		KB	D1	D2	B1	L1	L2	L3	WS	kg/100	PU	
250080	black	M12	3 - 6,5	12,0	8,3	6,9	7,9	19,6	13,6	15	0,024	10	4.250
250082	black	M16	5 - 10	16	10,9	9,6	15,5	23,4	16,9	22	0,024	10	1.700
250084	black	M20	8 - 12	20,0	14,1	12,5	10,0	25,0	18,1	24	0,024	10	1.200
250086	black	M20	10 - 14	20,0	15,0	14,8	10,0	28,5	18,5	27	1,620	10	1.190
250088	black	M20	10 - 14	20,0	15,0	14,8	15,0	28,5	18,5	27	17,000	10	1.190
250090	black	M25	13 - 18	25,0	18,6	18,4	15,2	29,4	22,3	33	2,690	10	680
250092	black	M32	18 - 25	32,0	26,0	25,0	14,7	34,5	25,7	42	4,560	10	340
250094	black	M40	22 - 32	40,0	33,7	33,1	18,4	41,7	31,3	54	8,100	5	230
250096	black	M50	30 - 38	50,0	41,9	40,0	17,8	44,2	31,3	61	10,100	5	160
250098	black	M63	34 - 44	61,0	55,0	43,2	18,5	44,6	32,7	66	11,400	5	120

Art. no.	colour		KB	D1	D2	B1	L1	L2	L3	WS	kg/100	PU	
250060	light-grey	PG7	3,5 - 6	12,5	8,3	6,9	7,9	20,0	13,3	15	0,024	10	4.250
250062	* light-grey	PG9	4 - 8	15,2	10,5	8,0	7,9	22,0	15,1	19	0,024	10	2.980
250064	* light-grey	PG11	5 - 10	18,3	13,2	10,5	7,9	23,7	18,3	22	0,024	10	2.040
250066	* light-grey	PG13,5	6 - 12	20,4	15,5	12,0	8,9	24,6	18,9	24	0,024	10	1.530
250068	* light-grey	PG16	10 - 14	22,5	17,2	14,0	9,8	26,2	19,5	27	0,024	10	1.190
250070	light-grey	PG21	13 - 18	28,3	22,4	18,4	10,8	30,0	23,7	33	0,024	10	680
250072	light-grey	PG29	18 - 25	37,0	30,6	25,0	10,8	35,0	27,4	42	0,024	10	380
250074	light-grey	PG36	22 - 32	47,0	35,3	35,5	14,5	42,3	30,3	53	0,024	5	200
250076	light-grey	PG42	30 - 38	54,0	40,0	40,0	14,5	44,0	31,2	60	0,024	5	140
250078	light-grey	PG48	34 - 44	59,3	43,2	46,0	15,6	42,7	31,3	65	0,024	5	130

Art. no.	colour		KB	D1	D2	B1	L1	L2	L3	WS	kg/100	PU	
250100	black	PG7	3,5 - 6	12,5	8,3	6,9	7,9	20,0	13,3	15	0,560	10	4.250
250102	black	PG9	4 - 8	15,2	10,5	8,0	7,9	22,0	15,1	19	7,500	10	2.980
250104	black	PG11	5 - 10	18,3	13,2	10,5	7,9	23,7	18,3	22	1,030	10	2.040
250106	black	PG13,5	6 - 12	20,4	15,5	12,0	8,9	24,6	18,9	24	1,400	10	1.530
250108	black	PG16	10 - 14	22,5	17,2	14,0	9,8	26,2	19,5	27	1,560	10	1.190
250110	black	PG21	13 - 18	28,3	22,4	18,4	10,8	30,0	23,7	33	2,480	10	680
250112	black	PG29	18 - 25	37,0	30,6	25,0	10,8	35,0	27,4	42	4,160	10	380
250114	black	PG36	22 - 32	47,0	35,3	35,5	14,5	42,3	30,3	53	8,240	5	200
250116	black	PG42	30 - 38	54,0	40,0	40,0	14,5	44,0	31,2	60	10,800	5	140
250118	black	PG48	34 - 44	59,3	43,2	46,0	15,6	42,7	31,3	65	11,600	5	130

SlimTop cable glands polyamide IP68

SlimTop - cable glands IP 68, metric or PG, assembled with washer and lock nut, industry

material: polyamide 6.6, (gland body: PA 6.6, halogen free, seal: TPR, halogen free, washer: PVC), colour: light-grey or black, temperature range: - 40°C to + 85°C, vibration protection: integrated anti-twist protection for vibration-firm assembly, fire class: according to UL 94 V-2, protection category: IP68, properties: integrated strain relief, not mounted, easy to install, RoHS-compliant

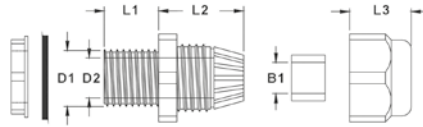

Art. no.	colour	KB	D1	D2	B1	L1	L2	L3	WS	kg/100	PU		
250140	light-grey	M12	3 - 6,5	12,0	7,3	7,1	8,0	19,6	12,7	15	0,400	10	4.250
250142	light-grey	M16	5 - 10	16,0	10,7	10,4	8,0	23,3	16,1	20	0,800	10	1.700
250044	light-grey	M20	8 - 12	20,0	14,1	12,5	10,0	25,0	18,1	24	0,024	10	1.200
250144	light-grey	M25	11 - 17	25,0	18,0	17,3	8,0	30,0	20,0	29	1,400	10	680
250146	light-grey	M32	15 - 21	32,0	25,7	21,6	10,0	35,4	24,1	36	2,900	10	340
250148	light-grey	M40	20 - 28	40,0	32,7	28,6	10,0	39,4	27,5	46	4,800	5	230
250150	light-grey	M50	27 - 35	50,0	42,4	35,8	12,0	43,4	31,8	55	8,300	5	160
250152	light-grey	M63	32 - 42	63,0	55,0	48,8	12,0	46,4	33,7	66	10,200	5	120
250120	light-grey	M12	3 - 6,5	12,0	7,3	7,1	8,0	19,6	12,7	15	0,400	10	4.250
250122	light-grey	M16	5 - 10	16,0	10,7	10,4	8,0	23,3	16,1	20	0,800	10	1.700
250084	black	M20	8 - 12	20,0	14,1	12,5	10,0	25,0	18,1	24	0,024	10	1.200
250124	light-grey	M25	11 - 17	25,0	18,0	17,3	8,0	30,0	20,0	29	1,400	10	680
250126	light-grey	M32	15 - 21	32,0	25,7	21,6	10,0	35,4	24,1	36	2,900	10	340
250128	light-grey	M40	20 - 28	40,0	32,7	28,6	10,0	39,4	27,5	46	4,800	5	230
250130	light-grey	M50	27 - 35	50,0	42,4	35,8	12,0	43,4	31,8	55	8,300	5	160
250132	light-grey	M63	32 - 42	63,0	55,0	48,8	12,0	46,4	33,7	66	10,200	5	120

Dummy plugs



Dummy plugs light-grey and black

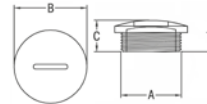

Art. no.	colour	A	B	DD	kg/100	PU		
250196	light-grey	M12	11,7	15,0	10,0	6,0	0,090	100
250198	light-grey	M16	15,7	20,0	10,5	6,0	0,150	100
250200	light-grey	M20	19,9	24,0	12,8	6,0	0,220	100
250202	light-grey	M25	24,7	29,7	12,8	7,8	0,350	100
250204	light-grey	M32	31,7	36,6	13,3	7,8	0,330	50
250206	light-grey	M40	39,9	45,8	13,4	7,8	0,420	50
250208	light-grey	M50	49,4	55,5	16,2	9,8	1,300	10
250210	light-grey	M63	62,4	69,3	17,5	11,8	1,800	10
250212	light-grey	PG7	12,2	14,8	10,0	6,0	0,090	100
250214	light-grey	PG9	15,1	18,7	10,4	6,0	0,140	100
250216	light-grey	PG11	18,5	21,7	10,4	6,0	0,140	100
250218	light-grey	PG13,5	20,3	23,7	10,3	6,0	0,210	100
250220	light-grey	PG16	22,3	27,0	10,3	6,0	0,290	100
250222	light-grey	PG21	28,2	32,8	12,8	7,8	0,480	100
250224	light-grey	PG29	37,0	44,1	13,2	7,8	0,400	50
250226	light-grey	PG36	47,0	52,6	13,7	7,8	0,500	50
250228	light-grey	PG42	54,0	59,5	16,2	9,6	1,300	10
250230	light-grey	PG48	59,6	64,2	17,5	11,8	1,800	10
250160	black	M12	11,7	15,0	10,0	6,0	0,090	100
250162	black	M16	15,7	20,0	10,5	6,0	0,150	100
250164	black	M20	19,9	24,0	10,5	6,0	0,220	100
250166	black	M25	24,7	29,7	12,8	7,8	0,350	100
250168	black	M32	31,7	36,6	13,3	7,8	0,330	50
250170	black	M40	39,9	45,8	13,4	7,8	0,420	50
250172	black	M50	49,4	55,5	16,2	9,8	1,300	10
250174	black	M63	62,4	69,3	17,5	11,8	1,800	10
250176	black	PG7	12,2	14,8	10,0	6,0	0,090	100
250178	black	PG9	15,1	18,7	10,4	6,0	0,140	100
250180	black	PG11	18,5	21,7	10,4	6,0	0,140	100
250182	black	PG13,5	20,3	23,7	10,3	6,0	0,210	100
250184	black	PG16	22,3	27,0	10,3	6,0	0,290	100
250186	black	PG21	28,2	32,8	12,8	7,8	0,480	100
250188	black	PG29	37,0	44,1	13,2	7,8	0,400	50
250190	black	PG36	47,0	52,6	13,7	7,8	0,500	50
250192	black	PG42	54,0	59,5	16,2	9,6	1,300	10
250194	black	PG48	59,6	64,2	17,5	11,8	1,800	10

haupa®

...convincing solutions

HAUPA GmbH & Co. KG, Koenigstr. 165-169, 42853 Remscheid, Phone: +49 (0)2191 8418-0, Fax: +49 (0)2191 8418-840, sales@haupa.com

Cable glands brass nickel-plated, IP68

INFO

Cable glands polyamide IP68

Properties:

integrated strain relief, fully mounted, RoHS-compliant.

HAUPA cable glands do protect electric equipment (switchboards, distribution boxes) against mechanical influences, dust, and humidity by connecting a cable tight and sealed to the housing.

HAUPA offers next to metric as well PG cable glands.

For an EMC-compatible installation, brass cable glands inclusive EMC insets should be used.

HAUPA cable glands are IP68 (dust and humidity) to protect human against the potential risk during usage.

Cable glands brass nickel-plated, IP68, fully mounted

Material: brass nickel-plated, (halogen free)

lock nut/washer: TPR

temperature range: - 40°C to + 120°C

protection category: IP68

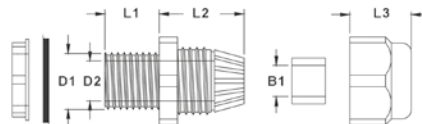

Art. no.	KB	D1	D2	B1	L1	L2	L3	WS	kg/100	PU	
250600	M12	3 - 6,5	12,0	8,4	6,8	6,2	17	10,9	14	0,024	10
250602 *	M16	4 - 8	16,0	12,0	8,6	7,7	18,0	12,9	18	0,024	10
250604 *	M20	6 - 12	20,0	16,0	11,9	8,1	20,0	13,9	22	0,030	10
250606 *	M25	10 - 14	25,0	20,5	14,5	8,5	20,2	14,0	24 - 27	0,043	10
250608 *	M32	15 - 22	32,0	27,0	21,5	10	24,5	18,0	35	0,085	10
250610	M40	18 - 25	40,0	35,5	25,5	11	27,0	19,0	40 - 45	0,140	5
250611	M40	22 - 30	40,0	35,0	30,5	11,0	28,0	20,5	45	0,140	5
250612	M50	32 - 38	50,0	44,0	39,0	13	32,0	23,0	55 - 57	0,260	5
250614	M63	37 - 44	63,0	55,5	44,5	14	34,0	22,0	64 - 68	0,380	5

Art. no.	KB	D1	D2	B1	L1	L2	L3	WS	kg/100	PU	
250630	PG7	3 - 6,5	12,0	8,5	6,9	6,5	16,5	10,8	14	0,013	10
250632 *	PG9	4 - 8	14,8	11,8	8,5	8,1	18,9	12,7	17	0,019	10
250634 *	PG11	5 - 10	18,2	14,2	10,5	8	18,5	13,5	20 - 21	0,028	10
250636 *	PG13,5	6 - 12	20,1	16,2	12,1	7,7	20,5	13,9	23 - 22	0,033	10
250638 *	PG16	10 - 14	22,2	18,3	14,5	8,3	19,7	14,2	25 - 24	0,038	10
250640 *	PG21	13 - 18	28,2	23,8	18,2	8,8	23,3	16,5	30	0,060	10
250642 *	PG29	18 - 25	36,6	32,4	25,2	10,0	26,3	19,4	40	0,111	10
250644	PG36	25 - 33	46,0	41,5	33,2	11,0	32,0	22,0	50	0,190	5
250646	PG42	32 - 38	53,8	47,7	38,7	12,0	32,0	22,0	57	0,255	5
250648	PG48	37 - 44	59,0	52,6	44,5	12,6	33,9	22,8	64	0,345	5

PG threads

Threads Ident.	external mm	Core-hole mm
Pg 7	12,5	11,3
Pg 9	15,2	13,9
Pg 11	18,6	17,3
Pg 13,5	20,4	19,1
Pg 16	22,5	21,2
Pg 21	28,3	26,8
Pg 29	37,0	35,5
Pg 36	47,0	45,5
Pg 42	54,0	52,5
Pg 48	59,3	57,8

Metric thread

Threads Ident.	external mm	Core-hole mm
M 12	12,0	12,5
M 16	16,0	16,5
M 20	20,0	20,5
M 25	25,0	25,5
M 32	32,0	32,5
M 40	40,0	40,5
M 50	50,0	50,5
M 63	63,0	63,5

Converting PG to metric

PG size	Diameter mm	Cable diameter mm	Conversion to metric mm
Pg 7	12,5	6,0	M 12 x 1,5
Pg 9	12,5	6,0	M 16 x 1,5
Pg 9	15,5	8,0	M 16 x 1,5
Pg 11	18,6	10,0	M 20 x 1,5
Pg 13,5	20,4	12,0	M 20 x 1,5
Pg 13,5	20,4	12,0	M 25 x 1,5
Pg 16	22,5	14,0	M 20 x 1,5
Pg 16	22,5	14,0	M 25 x 1,5
Pg 21	28,3	18,0	M 25 x 1,5
Pg 21	28,3	18,0	M 32 x 1,5
Pg 29	28,3	18,0	M 32 x 1,5
Pg 29	28,3	18,0	M 40 x 1,5
Pg 36	47,0	32,0	M 50 x 1,5
Pg 42	54,0	38,0	M 50 x 1,5
Pg 42	54,0	38,0	M 63 x 1,5
Pg 48	59,3	43,0	M 63 x 1,5

Wrench size for cable glands

Connecting threads PG	Wrench size	Connecting threads metric	Wrench size
PG7	SW 15	M12 x 1,5	SW 15
PG9	SW 19	M16 x 1,5	SW 19
PG11	SW 22	M20 x 1,5	SW 24
PG13,5	SW 24	M25 x 1,5	SW 30
PG16	SW 27	M32 x 1,5	SW 36
PG21	SW 33	M40 x 1,5	SW 46
PG29	SW 42	M50 x 1,5	SW 55
PG36	SW 53	M63 x 1,5	SW 66
PG42	SW 60		
PG48	SW 65		



Cable glands brass nickel-plated, IP68

EMC-Cable glands brass nickel-plated, IP68, fully mounted

To ensure correct EMP installation, the brass cable screws with EMP inserts should be used.

Material: brass nickel-plated, (halogen free)

lock nut/washer: TPR

temperature range: - 40°C to + 120°C

protection category: IP68

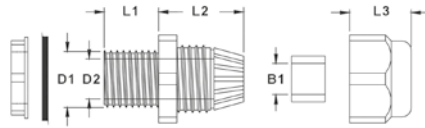
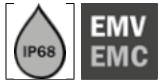

Art. no.		KB	D1	D2	B1	L1	L2	L3	WS	kg/100	PU
250650	M12	3 - 6,5	12,0	8,4	6,8	6,2	17,0	10,9	14	0,013	10
250652	M16	4 - 8	16,0	12,0	8,6	7,7	18,0	12,9	18	0,024	10
250654	M20	6 - 12	20,0	16,0	11,9	8,1	20,0	13,9	22	0,030	10
250656	M25	10-14	25,0	20,5	14,5	8,5	20,2	14,0	24-27	0,043	10
250658	M32	15-22	32,0	27,0	21,5	10,0	24,5	18,0	35	0,085	10
250660	M40	18-25	40,0	35,5	25,5	11,0	27,0	19,0	40-45	0,140	5
250661	M40	22-30	40,0	35,0	30,5	11,0	28,0	20,5	45	0,140	5
250662	M50	32-38	50,0	44,0	39,0	13,0	32,0	23,0	55-57	0,260	5
250664	M63	37-44	63,0	55,5	44,5	14,0	34,0	22,0	64-68	0,380	5

Art. no.		KB	D1	D2	B1	L1	L2	L3	WS	kg/100	PU
250666	PG7	3-6,5	12,0	8,5	6,9	6,5	16,5	10,8	14	0,013	10
250668	PG9	4-8	14,8	11,8	8,5	8,1	18,9	12,7	17	0,019	10
250670	PG11	5-10	18,2	14,2	10,5	8,0	18,5	13,5	20-21	0,028	10
250672	PG13,5	6-12	20,1	16,2	12,1	7,7	20,5	13,9	23-22	0,033	10
250674	PG16	10-14	22,2	18,3	14,5	8,3	19,7	14,2	25-24	0,038	10
250676	PG21	13-18	28,2	23,8	18,2	8,8	23,3	16,5	30	0,060	10
250678	PG29	18-25	36,6	32,4	25,2	10,0	26,3	19,4	40	0,111	10
250680	PG36	25-33	46,0	41,5	33,2	11,0	32,0	22,0	50	0,190	5
250682	PG42	32-38	53,8	47,7	38,7	12,0	32,0	22,0	57	0,255	5
250684	PG48	37-44	59,0	52,6	44,5	12,6	33,9	22,8	64	0,345	5

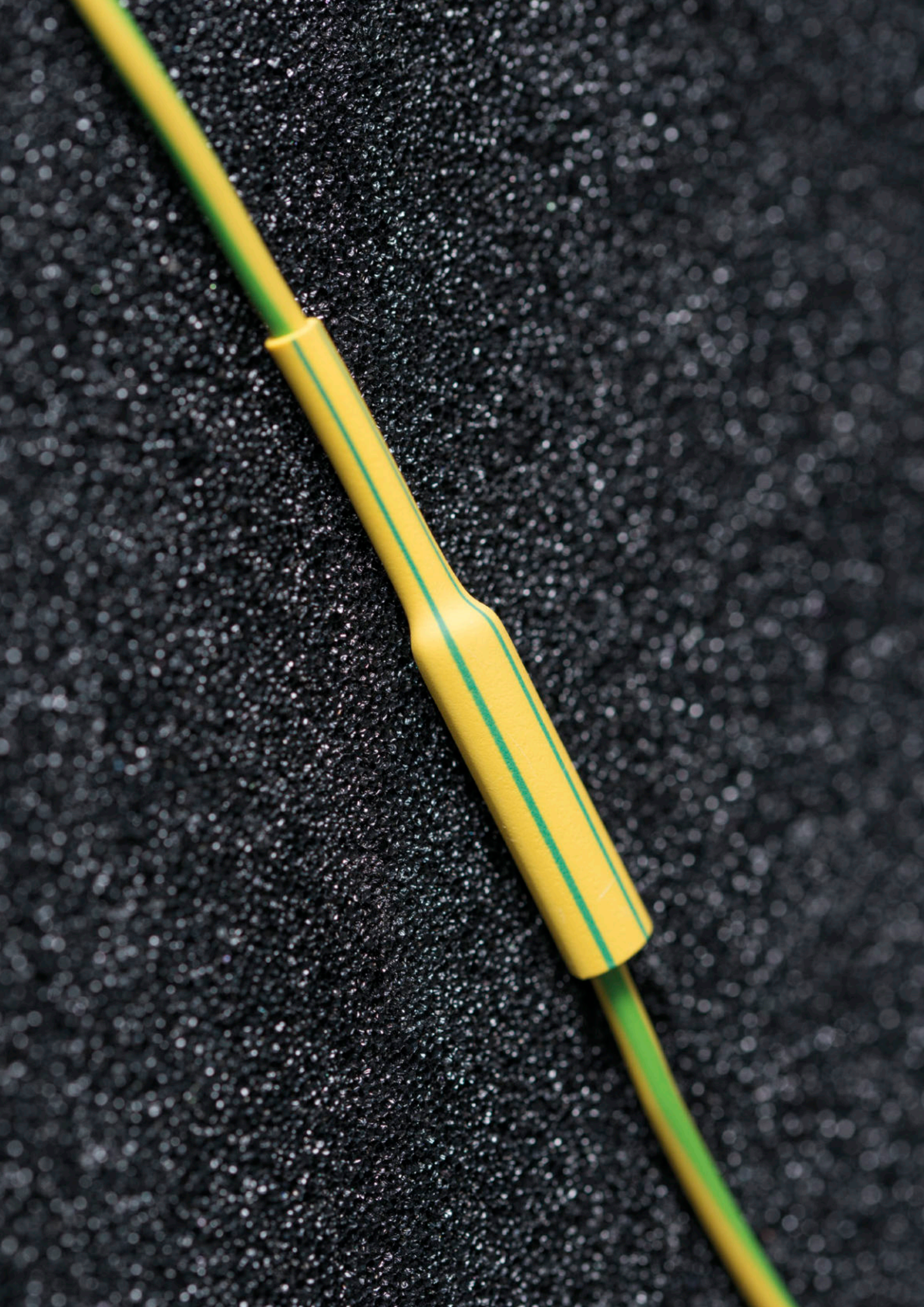

Heat shrinkable tubes
HUPshrink



INFO

HUPshrink - HAUPA Heat shrinkable tubes

Shrinking tubes are plastic tubes that rapidly contract upon exposure to heat - mostly through the injection of hot air. The object is inserted into the tube prior to heating and is therefore electrically insulated against its environment and protected from mechanical damage.

Application:

Heat shrinkable tubes serve as insulation and mechanical protection. Areas of application are, for instance, the repairing of components in electrical engineering or the cutting of cables. The three main electronic and electrotechnical applications of the tubes are for sealing, insulation and protection.

Adhesive:

The HAUPA heat shrinkable tubes HUPshrink are available with or without an adhesive lining on the inside. The tubes with an adhesive lining allow for precise work, offer robust connections and very good protection against corrosion.

Shrink ratio:

The basic material (plastic) used and the thickness of the wall determine how much a shrinking tube can expand. The shrink ratio gives the size of the original heat shrink tube in relation to its shrunken, final form. (Original size to (:) Final size). The higher the shrink ratio, the greater the variation in diameter that can be covered.

Important electrical performance features:

- Dielectric strength 19 kV/mm
- Specific electrical resistance 1 x 10¹⁴ Ω/cm

Notes for using:

- Cut the heat shrinkable tubes to desired length, this should be done on a smooth surface
- Conduct the shrinking on a clean, preferably dust and grease-free surface
- Start the shrink process unilaterally from one end of the tube
- Shrink temperature:
+70 °C - +115 °C (without adhesive lining) respectively
+80 °C - +115 °C (with adhesive lining)
- Optimum results when used with the matching Industrial hot air blower (Art. no. 262097 - see page 200).

Heat shrinkable tubes

Set HUPshrink21TW thin-walled 2:1 coloured

Radiation cross-linked polyolefin, self extinguishing according to MV SS 302, flexible, universally applicable, Dielectric strength: 15 - 25 KV/mm according to DIN 53481, shrinking temperature > 70° C, continuous operating temperature - 55° C to 125° C, 160 pieces, in plastic box, thin-walled

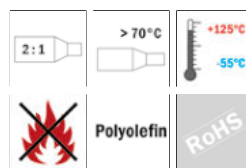

Art. no.					kg	PU
267202 *	2:1	6 colours		160-pieces	0,060	1

Set HUPshrink31DW-A double-walled 3:1 with adhesive lining

Radiation cross-linked polyolefin, self extinguishing according to MV SS 302, flexible, universally applicable, Dielectric strength: 15 - 25 KV/mm according to DIN 53481, shrinking temperature > 80° C, continuous operating temperature - 55° C to 125° C, 25 pieces, in plastic box, double-walled, with adhesive lining

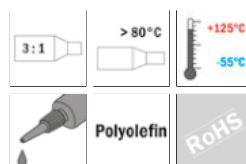

Art. no.					kg	PU
267204 *	3:1	black		25-pieces	0,060	1

Set HUPshrink21TW thin-walled 2:1 coloured

Radiation cross-linked polyolefin, self extinguishing according to MV SS 302, flexible, universally applicable, Dielectric strength: 15 - 25 KV/mm according to DIN 53481, shrinking temperature > 70° C, continuous operating temperature - 55° C to 125° C, 160 pieces, in plastic box, thin-walled

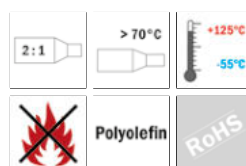

Art. no.					kg	PU
267206 *	2:1	4 colours		160-pieces	0,060	1

Set HUPshrink21TW thin-walled 2:1

Radiation cross-linked polyolefin, self extinguishing according to MV SS 302, flexible, universally applicable, Dielectric strength: 15 - 25 KV/mm according to DIN 53481, shrinking temperature > 70° C, continuous operating temperature - 55° C to 125° C, 160 pieces, in plastic box, thin-walled

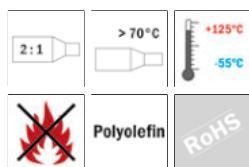

Art. no.					kg	PU
267200 *	2:1	black		160-pieces	0,060	1

Heat shrinkable tubes

HUPshrink21TW thin-walled 2:1

Radiation cross-linked polyolefin, self extinguishing according to MV SS 302, flexible, universally applicable, Dielectric strength: 15 - 25 KV/mm according to DIN 53481, shrinking temperature > 70° C, continuous operating temperature - 55° C to 125° C, 50 pieces, 0.1 m long packaged in a polybag, thin-walled



Art. no.	m	Ø before	Ø after	kg	PU	
267000	0,1	2:1	2,5	1,0	0,020	50
267002	0,1	2:1	3,5	1,5	0,035	50
267004	0,1	2:1	5,0	2,25	0,050	50
267006	0,1	2:1	6,5	3,0	0,067	50
267008	0,1	2:1	9,6	4,5	0,040	25
267010	0,1	2:1	12,7	6,0	0,022	10
267012	0,1	2:1	19,0	9,0	0,030	10
267014	0,1	2:1	26,0	12,5	0,050	10

HUPshrink21TW thin-walled 2:1 Box

Radiation cross-linked polyolefin, self extinguishing according to MV SS 302, flexible, universally applicable, Dielectric strength: 15 - 25 KV/mm according to DIN 53481, shrinking temperature > 70° C, continuous operating temperature - 55° C - 125° C, 5/10m roll in dispenser, thin-walled

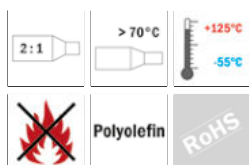

Art. no.	m	Ø before	Ø after	kg	PU	
267016	10	2:1	2,5	1,0	0,150	1
267018	10	2:1	3,5	1,5	0,160	1
267020	10	2:1	5,0	2,25	0,183	1
267022	5	2:1	6,5	3,0	0,111	1
267024	5	2:1	9,6	4,5	0,133	1
267026	5	2:1	12,7	6,0	0,210	1
267028	5	2:1	19,0	9,0	0,222	1
267030	5	2:1	26,0	12,5	0,350	1
267032	10	2:1	2,5	1,0	0,150	1
267034	10	2:1	3,5	1,5	0,160	1
267036	10	2:1	5,0	2,25	0,183	1
267038	5	2:1	6,5	3,0	0,111	1
267040	5	2:1	9,6	4,5	0,133	1
267042	5	2:1	12,7	6,0	0,210	1
267044	5	2:1	19,0	9,0	0,222	1
267046	5	2:1	26,0	12,5	0,350	1
267132	10	2:1	2,5	1,0	0,350	1
267134	10	2:1	3,5	1,5	0,350	1
267136	10	2:1	5,0	2,25	0,350	1
267138	5	2:1	6,5	3,0	0,350	1
267140	5	2:1	9,6	4,5	0,350	1
267142	5	2:1	12,7	6,0	0,350	1
267144	5	2:1	19,0	9,0	0,350	1
267146	5	2:1	26,0	12,5	0,350	1

HUPshrink21 thin-walled 2:1 blister package

of polyolefin, radiation interlaced, self extinguished according to MV SS 302, thin and flexible, dielectric strength 15 - 25 KV/mm acc. to DIN 53481, operating temperature: - 55° C to 125° C, shrinking temperature: > 70° C, 1 m length in self-service-pack

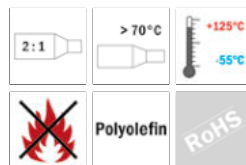

Art. no.	m	Ø before	Ø after	kg	PU	
262085	1	2:1	4,8	2,4	0,007	1
262086	1	2:1	6,4	3,2	0,010	1
262087	1	2:1	9,5	4,8	0,012	1
262088	1	2:1	12,7	6,4	0,017	1
262089	1	2:1	19,0	9,5	0,035	1
262090	1	2:1	25,4	12,7	0,045	1

HUPshrink21TW thin-walled 2:1

Radiation cross-linked polyolefin, self extinguishing according to MV SS 302, flexible, universally applicable, Dielectric strength: 15 - 25 KV/mm according to DIN 53481, shrinking temperature > 70° C, continuous operating temperature - 55° C to 125° C, 25m roll packaged in a polybag, thin-walled

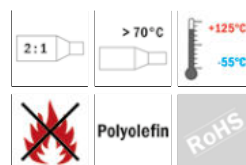

Art. no.	m	Ø before	Ø after	kg	PU	
267250/200	200	2:1	1,2	0,6	1,120	1
267252/200	200	2:1	1,6	0,8	1,200	1
267254/200	200	2:1	2,4	1,2	1,500	1
267048	25	2:1	2,5	1,0	0,250	1
267256/200	200	2:1	3,2	1,6	1,780	1
267050	25	2:1	3,5	1,5	0,339	1
267258/100	100	2:1	4,8	2,4	1,050	1
267052	25	2:1	5,0	2,25	0,401	1
267260/50	50	2:1	6,4	3,2	0,700	1
267054	25	2:1	6,5	3,0	0,420	1
267262/50	50	2:1	9,5	4,8	0,970	1
267282/50	50	2:1	9,5	4,8	0,970	1
267056	25	2:1	9,6	4,5	0,445	1
267058	25	2:1	12,7	6,0	0,745	1
267264/100	100	2:1	12,7	6,4	2,350	1
267284/100	100	2:1	12,7	6,0	2,350	1
267060	25	2:1	19,0	9,0	0,876	1
267266/50	50	2:1	19,0	9,5	2,165	1
267062	25	2:1	26,0	12,5	1,320	1
267268/50	50	2:1	25,4	12,7	3,040	1
267410/25	25	2:1	38,1	19,0	1,375	1
267411/25	25	2:1	50,8	25,4	1,825	1
267412/25	25	2:1	76,0	38,0	2,750	1
267413/25	25	2:1	102,0	51,0	3,625	1
267480/100	100	3:1	12,7	4,0	1,500	1

haupa®

... convincing solutions

Heat shrinkable tubes

HUPshrink21TW thin-walled 2:1

Radiation cross-linked polyolefin, self extinguishing according to MV SS 302, flexible, universally applicable, Dielectric strength: 15 - 25 KV/mm according to DIN 53481, shrinking temperature > 70° C, continuous operating temperature - 55° C to 125° C, packaged in a polybag, thin-walled

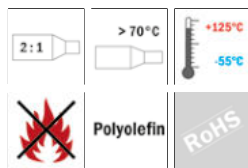

Art. no.	m	Ø before	Ø after	kg	PU
267250	1,2	2:1	1,2	0,6	1
267252	1,2	2:1	1,6	0,8	1
267254	1,2	2:1	2,5	1,0	1
267256	1,2	2:1	3,5	1,5	1
267258	1,2	2:1	5,0	2,25	1
267260	1,2	2:1	6,5	3,0	1
267262	1,2	2:1	9,6	4,5	1
267264	1,2	2:1	12,7	6,0	1
267266	1,2	2:1	19,0	9,0	1
267268	1,2	2:1	26,0	12,5	1
267272	1,2	2:1	1,6	0,8	1
267274	1,2	2:1	2,5	1,0	1
267276	1,2	2:1	3,5	1,5	1
267278	1,2	2:1	5,0	2,25	1
267280	1,2	2:1	6,5	3,0	1
267282	1,2	2:1	9,6	4,5	1
267284	1,2	2:1	12,7	6,0	1
267286	1,2	2:1	19,0	9,0	1
267288	1,2	2:1	26,0	12,5	1
267292	1,2	2:1	1,6	0,8	1
267294	1,2	2:1	2,5	1,0	1
267296	1,2	2:1	3,5	1,5	1
267298	1,2	2:1	5,0	2,25	1
267300	1,2	2:1	6,5	3,0	1
267302	1,2	2:1	9,6	4,5	1
267304	1,2	2:1	12,7	6,0	1
267306	1,2	2:1	19,0	9,0	1
267308	1,2	2:1	26,0	12,5	1
267312	1,2	2:1	1,6	0,8	1
267314	1,2	2:1	2,5	1,0	1
267316	1,2	2:1	3,5	1,5	1
267318	1,2	2:1	5,0	2,25	1
267320	1,2	2:1	6,5	3,0	1
267322	1,2	2:1	9,6	4,5	1
267324	1,2	2:1	12,7	6,0	1
267326	1,2	2:1	19,0	9,0	1
267328	1,2	2:1	26,0	12,5	1
267332	1,2	2:1	1,6	0,8	1
267334	1,2	2:1	2,5	1,0	1
267336	1,2	2:1	3,5	1,5	1
267338	1,2	2:1	5,0	2,25	1
267340	1,2	2:1	6,5	3,0	1
267342	1,2	2:1	9,6	4,5	1
267344	1,2	2:1	12,7	6,0	1
267346	1,2	2:1	19,0	9,0	1
267348	1,2	2:1	26,0	12,5	1
267352	1,2	2:1	1,6	0,8	1
267354	1,2	2:1	2,5	1,0	1
267356	1,2	2:1	3,5	1,5	1
267358	1,2	2:1	5,0	2,25	1
267360	1,2	2:1	6,5	3,0	1
267362	1,2	2:1	9,6	4,5	1
267364	1,2	2:1	12,7	6,0	1
267366	1,2	2:1	19,0	9,0	1
267368	1,2	2:1	26,0	12,5	1

Art. no.	m	Ø before	Ø after	kg	PU
267372	1,2	2:1	1,6	0,8	1
267374	1,2	2:1	2,5	1,0	1
267376	1,2	2:1	3,5	1,5	1
267378	1,2	2:1	5,0	2,25	1
267380	1,2	2:1	6,5	3,0	1
267382	1,2	2:1	9,6	4,5	1
267384	1,2	2:1	12,7	6,0	1
267386	1,2	2:1	19,0	9,0	1
267388	1,2	2:1	26,0	12,5	1
267392	1,2	2:1	1,6	0,8	1
267394	1,2	2:1	2,5	1,0	1
267396	1,2	2:1	3,5	1,5	1
267398	1,2	2:1	5,0	2,25	1
267400	1,2	2:1	6,5	3,0	1
267402	1,2	2:1	9,6	4,5	1
267404	1,2	2:1	12,7	6,0	1
267406	1,2	2:1	19,0	9,0	1
267408	1,2	2:1	26,0	12,5	1

HUPshrink31DW double-walled 3:1

Radiation cross-linked polyolefin, self extinguishing according to MV SS 302, flexible, universally applicable, Dielectric strength: 15 - 25 KV/mm according to DIN 53481, shrinking temperature > 70° C, continuous operating temperature - 55° C to 135° C, 1.2m packaged in a polybag, double-walled

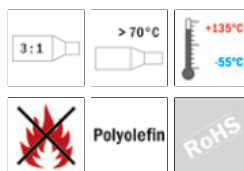

Art. no.	m	Ø before	Ø after	kg	PU
267430	1,2	3:1	3,0	1,0	1
267432	1,2	3:1	6,0	2,0	1
267434	1,2	3:1	9,0	3,0	1
267436	1,2	3:1	12,0	4,0	1
267438	1,2	3:1	18,0	6,0	1
267440	1,2	3:1	25,0	8,0	1
267442	1,2	3:1	3,0	1,0	1
267444	1,2	3:1	6,0	2,0	1
267446	1,2	3:1	9,0	3,0	1
267448	1,2	3:1	12,0	4,0	1
267450	1,2	3:1	18,0	6,0	1
267452	1,2	3:1	25,0	8,0	1

Heat shrinkable tubes with adhesive lining

HUPshrink31MW-A | HUPshrink41MW-A medium-walled 3:1, 4:1 with adhesive lining

Radiation cross-linked polyolefin, self extinguishing according to MV SS 302, flexible, universally applicable, Dielectric strength: 15 - 25 KV/mm according to DIN 53481, shrinking temperature > 80° C, continuous operating temperature - 45° C to 110° C, 1.2m packaged in a polybag, medium-walled, with adhesive lining

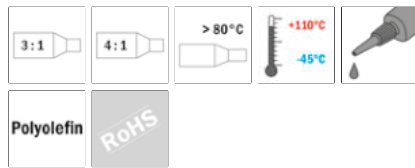

Art. no.	m		∅ before	∅ after	kg	PU
267102	1,2	4:1	8,0	2,0	0,050	1
267104	1,2	4:1	12,0	3,0	0,061	1
267106	1,2	4:1	22,0	6,0	0,118	1
267108	1,2	4:1	33,0	8,0	0,180	1
267118	1,2	4:1	95,0	25,0	0,510	1

267110	1,2	3:1	40,0	12,0	0,210	1
267112	1,2	3:1	55,0	16,0	0,300	1
267114	1,2	3:1	65,0	19,0	0,380	1
267116	1,2	3:1	75,0	22,0	0,395	1
267120	1,2	3:1	115,0	34,0	0,830	1

HUPshrink31DW-A | HUPshrink41DW-A double-walled 3:1, 4:1 with adhesive lining

Radiation cross-linked polyolefin, self extinguishing according to MV SS 302, flexible, universally applicable, Dielectric strength: 15 - 25 KV/mm according to DIN 53481, shrinking temperature > 80° C, continuous operating temperature - 45° C to 110° C, 1.2m packaged in a polybag, double-walled, with adhesive lining

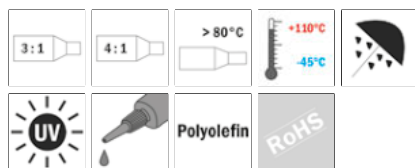

Art. no.	m		∅ before	∅ after	kg	PU
267064	1,2	3:1	3,2	1,0	0,025	1
267066	1,2	3:1	4,8	1,6	0,035	1
267068	1,2	3:1	6,4	2,0	0,040	1
267070	1,2	3:1	9,5	3,0	0,050	1
267074	1,2	3:1	12,7	4,0	0,060	1
267078	1,2	3:1	19,1	6,0	0,080	1
267080	1,2	3:1	24,5	8,0	0,100	1
267084	1,2	3:1	38,1	13,0	0,170	1
267088	1,2	4:1	52,0	13,0	0,290	1

HUPshrink31DW-A double-walled 3:1 with adhesive lining Box

Radiation cross-linked polyolefin, self extinguishing according to MV SS 302, flexible, universally applicable, Dielectric strength: 15 - 25 KV/mm according to DIN 53481, shrinking temperature > 80° C, continuous operating temperature - 45° C - 110° C, 5/10m roll in dispenser, double-walled, with adhesive lining

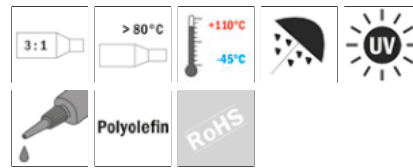

Art. no.	m		∅ before	∅ after	kg	PU
267090	10	3:1	3,0	1,0	0,205	1
267092	5	3:1	6,0	2,0	0,215	1
267094	5	3:1	9,0	3,0	0,220	1

HUPshrink31DW-A double-walled 3:1 with adhesive lining

Radiation cross-linked polyolefin, self extinguishing according to MV SS 302, flexible, universally applicable, Dielectric strength: 15 - 25 KV/mm according to DIN 53481, shrinking temperature > 80° C, continuous operating temperature - 45° C - 110° C, 5m roll, double-walled, with adhesive lining

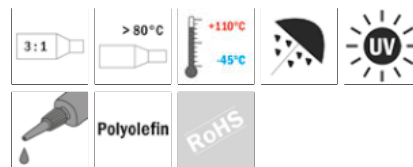

Art. no.	m		∅ before	∅ after	kg	PU
267096	5	3:1	12,0	4,0	0,320	1
267098	5	3:1	19,0	6,0	0,403	1
267100	5	3:1	24,0	8,0	0,570	1

haupa®

... convincing solutions

HAUPA GmbH & Co. KG, Koenigstr. 165-169, 42853 Remscheid, Phone: +49 (0)2191 8418-0, Fax: +49 (0)2191 8418-840, sales@haupa.com

Heat shrinkable tubes with adhesive lining

HUPshrink41DW-A double-walled 4:1 with adhesive lining

Radiation cross-linked polyolefin, self extinguishing according to MV SS 302, flexible, universally applicable, Dielectric strength: 15 - 25 KV/mm according to DIN 53481, shrinking temperature > 80° C, continuous operating temperature - 45° C to 110° C, 1.2m packaged in a polybag, double-walled, with adhesive lining

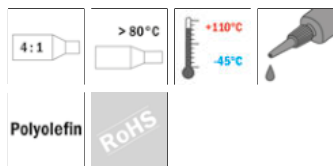

Art. no.	m	Ø before	Ø after	kg	PU
267460	1,2	4:1	4,0	1,0	0,013
267462	1,2	4:1	8,0	2,0	0,017
267464	1,2	4:1	12,0	3,0	0,030
267466	1,2	4:1	16,0	4,0	0,051
267468	1,2	4:1	24,0	6,0	0,103
267470	1,2	4:1	32,0	8,0	0,120
267472	1,2	4:1	52,0	13,0	0,183

Heat-shrinkable end caps

- Designed with a layer of spiral coated hot melt adhesive in the internal surface of the end cap.
- Provides highly resistant to moisture, fungus, and corrosion.
- Recommended for use both in open air and on underground power distribution cables with PVC, lead or XLPE sheaths.
- Shrinkable Ratio: 2:1.
- Electrical insulation to 1000V.
- Easy installation over the cable end.
- Abrasion resistance and mechanical protection.

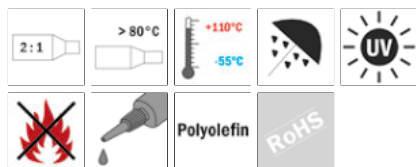

Art. no.	Cable-Ø	KaL	WaSt	kg	PU
267500	4 - 10	15	2,6	0,003	100
267502	6 - 16	25	2,8	0,005	50
267506	18 - 32	40	3,3	0,018	25
267508	28 - 48	50	3,5	0,044	10
267510	45 - 68	55	4,0	0,064	10
267512	55 - 90	70	4,0	0,110	25
267514	65 - 110	70	4,0	0,143	20

Industrial hot air blower

Torch brazing set SolderingKit

12-pieces, for pocket lighter butane gas, with Piezo ignition, heating time: +/- 25 seconds (peak), performance can be infinitely regulated, temperatures with naked flame up to bis 1200 °C, brazing up to 550 °C, heat shrinking up to 680 °C, burn time approximately 60 minutes, in black plastic case.



Art. no.	Content	kg	PU
262098	12	0,670	1

Industrial hot air blower for heat shrinkable tubes

Electronic hot air blower with continuous temperature control and two blower levels, characterised by low weight and slim design. This makes it ideal for long and fatigue-free working and for use in difficult to access areas. The temperature control is continuous, and the air volume can be set to two different levels. For heat shrinkable tubes.

Technical data:

Length/Ø (at shock protection): 325 mm / 85 mm
 Voltage: 230 V / 50 Hz (special voltages possible)
 Power: 2000 W
 Temperature: 100° - 600° C continuous control
 Air volume: min. 300 l/min. / max. 500 l/min.



Art. no.	kg	PU
262097	0,773	1

Electrical insulating tape



Electro insulating tape

INFO

Electro insulating tape

Typical uses in electrical installations

Insulation, Sealing, Padding, Protection from corrosion, heat, electromagnetic faults, cable marking, etc

Benefits:

- VDE tested
- DIN EN 60454-3-1
- Easy to unroll
- Very good adhesive properties
- High flexibility
- Wrinkle free adhesion to uneven surfaces
- Tear-proof and resistant to aging
- Flame retardant
- Self-extinguishing
- Temperature resistant from -30°C to 105°C
- Water, weather and UV resistant
- With many uses
- For insulating, bundling, marking
- Available in 10 colours

Electrical insulating tape "HUPTape-15"

Material: PVC, in tested VDE quality, in accordance with DIN EN 60454-3-1, flame retardant, self-extinguishing. Temperature resistant from -30°C to 105°C, water, weather and UV resistant. Highly flexible with very good adhesive properties, versatile in its uses, tear-resistant and durable, for insulating, bundling and marking. Available in ten colours.



Art. no.	widht/mm	length/m	strength	kg	PU
263800 *	15	10	0,15	0,035	120 10
263802 *	15	10	0,15	0,035	120 10
263804	15	10	0,15	0,035	120 10
263806	15	10	0,15	0,035	120 10
263808 *	15	10	0,15	0,035	120 10
263810 *	15	10	0,15	0,035	120 10
263812	15	10	0,15	0,035	120 10
263814	15	10	0,15	0,035	120 10
263816	15	10	0,15	0,035	120 10
263818 *	15	10	0,15	0,035	120 10

Art. no.	widht/mm	length/m	strength	kg	PU
263822	15	20	0,15	0,060	60 10
263824	15	20	0,15	0,060	60 10
263826	15	20	0,15	0,060	60 10
263828	15	20	0,15	0,060	60 10
263830	15	20	0,15	0,060	60 10
263832	15	20	0,15	0,060	60 10
263834	15	20	0,15	0,060	60 10
263836	15	20	0,15	0,060	60 10
263838	15	20	0,15	0,060	60 10
263840	15	20	0,15	0,060	60 10

Art. no.	widht/mm	length/m	strength	kg	PU
263842 *	19	20	0,15	0,076	48 8
263844 *	19	20	0,15	0,076	48 8
263846	19	20	0,15	0,076	48 8
263848	19	20	0,15	0,076	48 8
263850 *	19	20	0,15	0,076	48 8
263852 *	19	20	0,15	0,076	48 8
263854	19	20	0,15	0,076	48 8
263856	19	20	0,15	0,076	48 8
263858	19	20	0,15	0,076	48 8
263860 *	19	20	0,15	0,076	48 8

Art. no.	widht/mm	length/m	strength	kg	PU
263902	19	25	0,15	0,084	48 8
263904	19	25	0,15	0,084	48 8
263906	19	25	0,15	0,084	48 8
263908	19	25	0,15	0,084	48 8
263910	19	25	0,15	0,084	48 8
263912	19	25	0,15	0,084	48 8
263914	19	25	0,15	0,084	48 8
263916	19	25	0,15	0,084	48 8
263918	19	25	0,15	0,084	48 8
263920	19	25	0,15	0,084	48 8

Art. no.	widht/mm	length/m	strength	kg	PU
263862	25	20	0,15	0,100	36 6
263864	25	20	0,15	0,100	36 6
263866	25	20	0,15	0,100	36 6
263868	25	20	0,15	0,101	36 6
263870	25	20	0,15	0,100	36 6
263872	25	20	0,15	0,100	36 6
263874	25	20	0,15	0,100	36 6
263876	25	20	0,15	0,100	36 6
263878	25	20	0,15	0,100	36 6
263880	25	20	0,15	0,100	36 6

Art. no.	widht/mm	length/m	strength	kg	PU
263882	19	33	0,15	0,120	48 8
263884	19	33	0,15	0,120	48 6
263886	19	33	0,15	0,120	48 6
263888	19	33	0,15	0,120	48 6
263890	19	33	0,15	0,120	48 6
263892	19	33	0,15	0,120	48 6
263894	19	33	0,15	0,120	48 6
263896	19	33	0,15	0,120	48 6
263898	19	33	0,15	0,120	48 6
263900	19	33	0,15	0,120	48 6

Rainbow-Pack

- VDE tested
- DIN EN 60454-3-1
- Water, weather and UV resistant



Art. no.	widht/mm	length/m	strength	PU
263820	15	10	0,15	10-pieces 1
263861	19	20	0,15	10-pieces 1

Electro insulating tape

Self-welding

Cold-resistant insulation tape "HUPtape-22plus"



- Excellent wrapping properties
- Can be processed even at very low temperatures
- Extreme weather proof (UV resistant)
- Resistant to corrosion, acids and lyes
- Processing temperature: -18°C to + 60°C
- Individually packaged in plastic box



Art. no.	TL	widht/mm	strength	kg	PU
263930	20 m	19	0,215	0,105	1

Textile tape

- Particularly strong adhesive, UV-resistant
- 50 m



Art. no.	TL	widht/mm	colour	kg	PU
393016	50 m	50	grey	0,400	1

Self-welding

Self-welding insulation tape "HUPtape76seal"



- Forms homogenous welding wraps
- Excellent dielectric properties
- Weather proof (UV resistant)
- Insulation on medium voltage cables up to 69 kV
- Resistant to corrosion, acids and lyes
- Individual in box packaging



Art. no.	TL	widht/mm	strength	kg	PU
263940	9 m	19	0,76	0,203	1

haupa[®]

... convincing solutions

HAUPA GmbH & Co. KG, Koenigstr. 165-169, 42853 Remscheid, Phone: +49 (0)2191 8418-0, Fax: +49 (0)2191 8418-840, sales@haupa.com

Routine tests

Safety advice for working with live voltage

The basic requirements for working with live voltage are safety-insulated tools. Legal regulations and the following safety advice should always be observed:

1. Transport your safety tools such that damage to the insulation is avoided.
2. Before use, make sure that the insulation is not damaged. Damaged tools must not be used.
3. Keep your safety tools clean and dry.
4. When working overhead or when using cutting pliers, protective glasses must be worn.
5. For your own safety, keep your work space clean and tidy when working with live voltage.
6. In enclosed, cramped spaces, protective clothing and equipment must be worn (e.g. safety gloves, covering drapes, protective hoods)
7. Only use suitable and tested tools. Make sure that loose and cut off parts do not fall onto live components.

Routine tests in accordance with VDE Norm 1000 V IEC 60900:2012



Cold-heading test

In this test, the toughness of the PVC material is checked by dropping a weight onto the tools which have been cooled down to -25°C . The tools must not show any cracking or other damage after the test.



Testing the adhesive strength of the PVC coating

After pliers have been stored for 168 hours at $+70^{\circ}\text{C}$, the adhesive power of the PVC coating is tested using a pulling force of 500 Nm. The insulation material must stay firmly attached to the basic tool.



Flame resistance test

To exclude any fire risks, only flame-proof PVC material is used.



Pressure test

No puncture must occur, while testing the tool with a voltage of 5,000 V AC when also applying a pressure of 20 Nm at a temperature of $+70^{\circ}\text{C}$ to the tool.

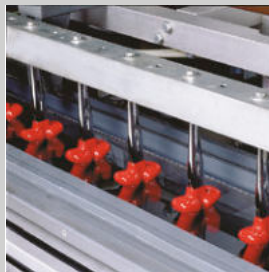

Testing the insulating properties

After storing the tools under water for 24 hours, the tools are tested using 10,000 V AC for three minutes, while simultaneously measuring the discharge current. During this time, no puncture or sparkover must occur.



Voltage test

Each safety tool is individually voltage tested. This means that all tools which bear the relevant mark have been tested at 10,000 V AC and are approved for a voltage of 1,000 V, ensuring 10-fold safety.

Screw profiles

-  Slot
-  Cross slot Phillips
-  Cross slot Pozidriv
-  Pozidriv/flat slot
-  Tx
-  Tx with safety pin
-  Allen screw
-  Hexagon head
-  Ball point

Patent ratchet wrench



The HAUPA ratchet wrench has a number of patented advantages. It is characterised particularly by ergonomic handling and high functional safety. The excellent interlocking of the wrench insert, which must be able to withstand pull-out forces of up to 500 N is the main feature.

The ratchet can be operated with one hand due to a cross slide made from non-conducting material (polyamide). It is ergonomically designed such that it is accessible with the thumb of the hand holding it. This cross slide, which is deep in the inside of the ratchet, also ensures that the testing voltage of 10 KV gema DIN 60900 can easily be achieved.



Safety of HAUPA products

All HAUPA products under the product area of "working with live voltage" have a 2-colour multi-layer insulation (wherever technically possible). This multi-layer insulation supports the current VBG4 regulations. This regulation requires that before use all tools are tested for any damage that can be seen externally. The 2-colour coating – the second insulating layer contrast in yellow – ensures that any damages are visible immediately.

Safety tools



INFO

Screwdriver range „HUPslim“

Industrial quality

Screwdriver range according to the new Norm IEC 60900. All blades are made from a high-quality molybdenum-vanadium steel, are matte-chrome-plated and spayed with red polypropylene. This ergonomic moulded 2-component handles from PP/TPE material guarantees a high security with normal power transmission. Every screwdriver is individually tested and marked according to the new Norm.

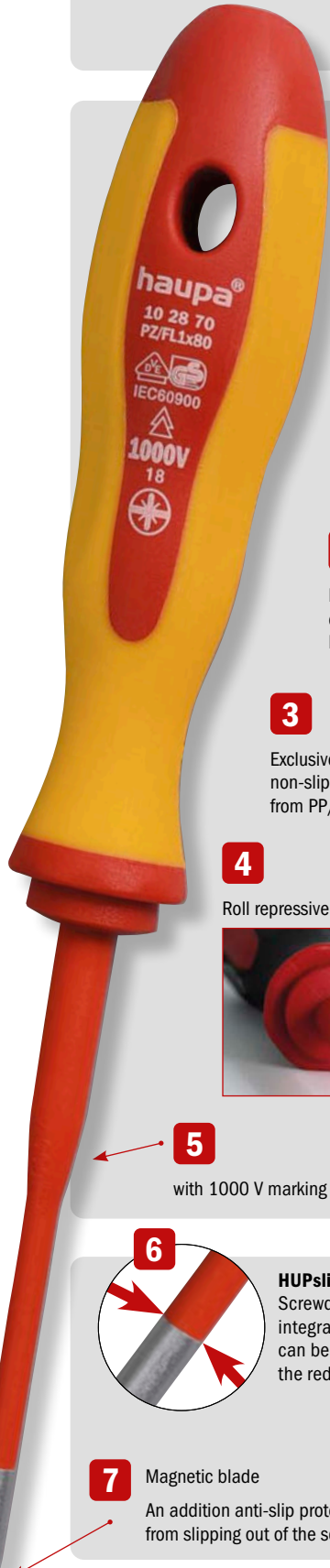
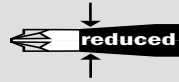

Injected blades profile on the top of the handle – for a fast access in the tool box, abrasion is not possible



2

Homogeneous sizes-adaptation of the screwdrivers haft for better power transmission. Increase of the soft area for stronger grip

3

Exclusive, ergonomic design, non-slipping 2-component handles from PP/TPE material

4

Roll repressive



5

with 1000 V marking injected



6

HUPslim
Screwdriver with reduced blade diameter and integrated protective insulation. Deep screwing can be achieved to a better standard thanks to the reduced blade diameter.

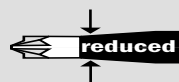

7

Magnetic blade

An addition anti-slip protection on Phillips profiles prevents the tool from slipping out of the screw. Silver tip protects from corrosion.

VDE screwdrivers „HUPslim“ 1000 V

Screwdriver „HUPslim“ 1000 V with PZ slot profile



Specifications and advantages of the PZ/FL profile.

The PZ/FL profile can only be used for combination screws that were previously screwed with a slot or recessed head PZ type screwdriver. The screws have an inner PZ profile with an additional cross slot that also allows it to be screwed with a slot screwdriver.



Area of application for PZ/FL profile

The screws are mainly used in electrical installation in automatic circuit breakers and safety switches

HUPslim

Screwdriver with reduced blade diameter and integrated protective insulation. Deep screwing can be achieved to a better standard thanks to the reduced blade diameter.

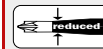
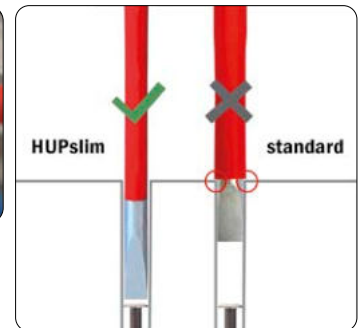

Art. no.	size	BL	TL	form	kg	PU
102870	1	80	205	PZ/FL	0,062	1
102872	2	100	270	PZ/FL	0,096	1

Screwdriver set „HUPslim“ 1000 V with PZ slot profile



with 2 component handle made from PP/TPE material, blade made from molybdenum vanadium steel, hardened, blasted, routine checked, insulated

HUPslim

Screwdriver with reduced blade diameter and integrated protective insulation. Deep screwing can be achieved to a better standard thanks to the reduced blade diameter.

Contents:

- 102870
- 102872



Art. no.	size	form	set	kg	PU
102879	1 + 2	PZ/FL	2-pieces	0,195	1

VDE screwdrivers „HUPslim“ 1000 V

Electricians' screwdrivers „HUPslim“ 1000 V Slot

with 2 component handle made from PP/TPE material, blade made from molybdenum vanadium steel, hardened, blasted, routine checked, insulated

HUPslim

Screwdriver with reduced blade diameter and integrated protective insulation. Deep screwing can be achieved to a better standard thanks to the reduced blade diameter.



1000 V IEC 60900

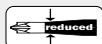

Art. no.	CW	KSt	BL	TL	kg	PU
102914	3,5	0,6	100	185	0,034	1
102916	4	0,8	100	195	0,049	1
102918	5,5	1,0	125	230	0,070	1
102920	6,5	1,2	150	255	0,108	1

Electricians' screwdrivers „HUPslim“ 1000 V Slot

with 2 component handle made from PP/TPE material, blade made from molybdenum vanadium steel, hardened, blasted, routine checked, insulated

HUPslim

Screwdriver with reduced blade diameter and integrated protective insulation. Deep screwing can be achieved to a better standard thanks to the reduced blade diameter.



1000 V IEC 60900



Art. no.	CW	KSt	BL	TL	kg	PU
102917	4	1,0	100	195	0,049	1

Cross slotted screwdrivers „HUPslim“ 1000 V Phillips

with 2 component handle made from PP/TPE material, blade made from molybdenum vanadium steel, hardened, blasted, routine checked, insulated, engraving on the blade ensures extra grip in the screw

HUPslim

Screwdriver with reduced blade diameter and integrated protective insulation. Deep screwing can be achieved to a better standard thanks to the reduced blade diameter.



1000 V IEC 60900

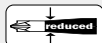

Art. no.	size	BL	TL	form	kg	PU
102942	1	80	175	PH	0,061	1
102944	2	100	205	PH	0,095	1

Cross slotted screwdrivers „HUPslim“ 1000 V Pozidriv

with 2 component handle made from PP/TPE material, blade made from molybdenum vanadium steel, hardened, blasted, routine checked, insulated

HUPslim

Screwdriver with reduced blade diameter and integrated protective insulation. Deep screwing can be achieved to a better standard thanks to the reduced blade diameter.



1000 V IEC 60900

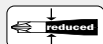

Art. no.	size	BL	TL	form	kg	PU
102952	1	80	175	PZ	0,061	1
102954	2	100	205	PZ	0,095	1

Screwdrivers set „HUPslim“ 1000 V

with 2 component handle made from PP/TPE material, blade made from molybdenum vanadium steel, hardened, blasted, routine checked, insulated, 6-pieces.

HUPslim

Screwdriver with reduced blade diameter and integrated protective insulation. Deep screwing can be achieved to a better standard thanks to the reduced blade diameter.

Contents:

1 HUPslim flat head screwdriver in 3.5 x 100 mm, 4 x 100 mm, 5.5 x 125 mm and 6.5 x 150 mm, HUPslim Phillips or Pozidriv screwdrivers in sizes 1 and 2



1000 V IEC 60900

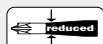

Art. no.	form	set	kg	PU
102999	Phillips	6-pieces	0,414	1
102999/PZ	Pozidriv	6-pieces	0,416	1



HUPslim

Screwdriver with reduced blade diameter and integrated protective insulation. Deep screwing can be achieved to a better standard thanks to the reduced blade diameter.

haupa

...convincing solutions

VDE screwdrivers „HUPslim“ 1000 V



Screwdrivers set „HUPslimPlus“ 1000 V



with 2 component handle made from PP/TPE material, blade made from molybdenum vanadium steel, hardened, blasted, routine checked, insulated, 12-pieces.

HUPslim

Screwdriver with reduced blade diameter and integrated protective insulation. Deep screwing can be achieved to a better standard thanks to the reduced blade diameter.

Contents:

- Electricians' screwdrivers HUPslim 3,5 x 0,6 x 100 mm, 4 x 0,8 x 100 mm, 4 x 1,0 x 100 mm, 5,5 x 1,0 x 125 mm, 6,5 x 1,2 x 150 mm
- Cross slotted screwdrivers HUPslim Phillips, size 1 and 2
- Cross slotted screwdrivers HUPslim Pozidriv, size 1 and 2
- Screwdriver HUPslim with PZ slot profile, size 1 and 2
- VDE/GS-Voltage testers 100 - 250 V, loose



1000 V IEC 60900



Art. no.	form	set	kg	PU
102980	Mix	12-pieces	0,874	1

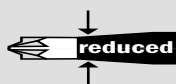

HUPslim

Screwdriver with reduced blade diameter and integrated protective insulation. Deep screwing can be achieved to a better standard thanks to the reduced blade diameter.



INFO

Screwdriver range

Industrial quality

Screwdriver range according to the new Norm IEC 60900. All blades are made from a high-quality molybdenum-vanadium steel, are matte-chrome-plated and spayed with red polypropylene. This ergonomic moulded 2-component handles from PP/TPE material guarantees a high security with normal power transmission. Every screwdriver is individually tested and marked according to the new Norm.



Injected blades profile on the top of the handle - for a fast access in the tool box, abrasion is not possible



2

Homogeneous sizes-adaptation of the screwdrivers haft for better power transmission. Increase of the soft area for stronger grip

3

Exclusive, ergonomic design, non-slipping 2-component handles from PP/TPE material

4

Roll repressive



5

with 1000 V marking injected

6

Magnetic blade

An addition anti-slip protection on Phillips profiles prevents the tool from slipping out of the screw. Silver tip protects from corrosion.

VDE screwdrivers 1000 V

Screwdriver 1000 V with PZ slot profile



Specifications and advantages of the PZ/FL profile.

The PZ/FL profile can only be used for combination screws that were previously screwed with a slot or recessed head PZ type screwdriver. The screws have an inner PZ profile with an additional cross slot that also allows it to be screwed with a slot screwdriver.



Area of application for PZ/FL profile

The screws are mainly used in electrical installation in automatic circuit breakers and safety switches



Art. no.	size	BL	TL	form	kg	PU
101870 *	1	80	205	PZ/FL	0,060	1
101872 *	2	100	270	PZ/FL	0,094	1

Screwdriver set 1000 V with PZ slot profile



with 2 component handle made from PP/TPE material, blade made from molybdenum vanadium steel, hardened, blasted, routine checked, insulated

Contents:

- 101870
- 101872



Art. no.	size	form	set	kg	PU
101879	1 + 2	PZ/FL	2-pieces	0,200	1

Electricians' screwdrivers 1000 V Slot



with 2 component handle made from PP/TPE material, blade made from molybdenum vanadium steel, hardened, blasted, routine checked, insulated



1000 V IEC 60900



Art. 101917

Art. no.	CW	KSt	BL	TL	kg	PU
101910 *	2,5	0,4	75	155	0,027	1
101912 *	3	0,5	100	185	0,029	1
101914 *	3,5	0,6	100	185	0,035	1
101916 *	4	0,8	100	195	0,052	1
101917	4	1,0	100	195	0,054	1
101918 *	5,5	1,0	125	230	0,070	1
101920	6,5	1,2	150	255	0,108	1
101922	8	1,2	175	295	0,177	1
101924	10	1,6	200	320	0,245	1

VDE screwdrivers 1000 V

Cross slotted screwdrivers 1000 V Phillips



with 2 component handle made from PP/TPE material, blade made from molybdenum vanadium steel, hardened, blasted, routine checked, insulated, engraving on the blade ensures extra grip in the screw



Art. no.	size	BL	TL	form	kg	PU
101940	0	60	145	PH	0,034	1
101942 *	1	80	175	PH	0,061	1
101944 *	2	100	205	PH	0,100	1
101946	3	150	270	PH	0,165	1

Cross slotted screwdrivers 1000 V Pozidriv



with 2 component handle made from PP/TPE material, blade made from molybdenum vanadium steel, hardened, blasted, routine checked, insulated



Art. no.	size	BL	TL	form	kg	PU
101950	0	60	135	PZ	0,033	1
101952 *	1	80	175	PZ	0,061	1
101954 *	2	100	205	PZ	0,095	1
101956	3	150	270	PZ	0,166	1

Screwdrivers 1000 V Tx



with 2 component handle made from PP/TPE material, blade made from molybdenum vanadium steel, hardened, blasted, routine checked, insulated



Art. no.	size	BL	TL	form	kg	PU
101850	8	100	185	TX	0,053	1
101852	9	100	185	TX	0,051	1
101854	10	100	195	TX	0,053	1
101856 *	15	100	195	TX	0,053	1
101858 *	20	100	195	TX	0,052	1
101860	25	125	220	TX	0,070	1
101862	27	125	230	TX	0,072	1
101864	30	150	255	TX	0,109	1
101866	40	175	295	TX	0,178	1

Screwdrivers 1000 V Square



with 2 component handle made from PP/TPE material, blade made from molybdenum vanadium steel, hardened, blasted, routine checked, insulated



Art. no.	size	BL	TL	form	kg	PU
102550	0	60	145	SQ	0,034	1
102552	1	80	175	SQ	0,061	1
102554	2	100	205	SQ	0,095	1
102556	3	150	270	SQ	0,166	1

Screwdrivers set 1000 V



with 2 component handle made from PP/TPE material, blade made from molybdenum vanadium steel, hardened, blasted, routine checked, insulated, 6-pieces.

Contents:

VDE Electricians' screwdriver 2,5 x 75 mm, 4 x 100 mm, 5,5 x 125 mm, 6,5 x 150 mm, VDE cross slotted screwdrivers Phillips or Pozidriv size 1 and 2



Art. no.	form	set	kg	PU
101999 *	Phillips	6-pieces	0,414	1
101999/PZ	Pozidriv	6-pieces	0,416	1

Screwdrivers set „Plus“ 1000 V



with 2 component handle made from PP/TPE material, blade made from molybdenum vanadium steel, hardened, blasted, routine checked, insulated, 15-pieces.

Contents:

- Electricians' screwdrivers 1000 V 2,5 x 0,4 x 75 mm, 3 x 0,5 x 100 mm, 4 x 0,8 x 100 mm, 5,5 x 1,0 x 125 mm
- Cross slotted screwdrivers 1000 V Phillips, size 1 and 2
- Cross slotted screwdrivers 1000 V Pozidriv, size 1 and 2
- Screwdriver 1000 V with PZ slot profile, size 1 and 2
- Screwdrivers 1000 V Tx, size 10, 15, 20, 25
- VDE/GS-Voltage testers 100 - 250 V, loose



Art. no.	form	set	kg	PU
101980	Mix	15-pieces	0,971	1



VDE socket wrenches 1000 V

Socket wrenches DIN 7445

with 2 component handle made from PP/TPE material, blade made from molybdenum vanadium steel, hardened, blasted, routine checked, insulated



⚠ 1000 V IEC 60900

Art. no.	WS	BL	TL	kg	PU
102520	4	125	220	0,105	1
102522	5	125	220	0,109	1
102524	5,5	125	220	0,116	1
102526	6	125	220	0,111	1
102528	7	125	230	0,116	1
102530	8	125	230	0,119	1
102532	9	125	230	0,122	1
102534	10	125	230	0,125	1
102536	11	125	245	0,167	1
102538	12	125	245	0,165	1
102540	13	125	245	0,175	1

Socket wrenches set DIN 7445

with 2 component handle made from PP/TPE material, blade made from molybdenum vanadium steel, hardened, blasted, routine checked, insulated.



Contents: 1 piece each 5 - 5,5 - 7 - 8 - 10 - 11 - 13 mm

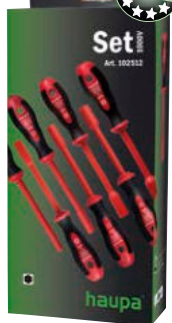

⚠ 1000 V IEC 60900

Art. no.	set	kg	PU
102512	7-pieces	1,065	1

„Vario“ 1000 V replaceable blade system



„Vario“ 1000 V replaceable blade system Vario!

in robust nylon bag, **Contents:** 2C exchangeable handle, screw cap, replaceable blade - slotted blade 0.4 x 2.5 / 0.5 x 3.0 / 0.8 x 4.0 / PH1 / PH2 or PZ1 / PZ2, PZ/FL 2, switch cabinet key - square 1, double-bit

Further characteristic feature include:

- High level of safety
- Exchangeable cap for use as an electronics screwdriver
- Switching cabinet key is integrated into the system
- Space-saving • Weight-saving
- Cost-effective price/performance ratio
- Meets all relevant standards

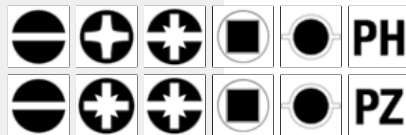

Art. no.	form	shank	set	kg	PU
102000-1	* Phillips	hexagonal	10 pieces	0,340	1
102000/PZ-1	* Pozidriv	hexagonal	10 pieces	0,334	1

Art. no.	nylon bag	width	height	depth	kg	PU
102042-1	empty	250	135	30	0,100	1

Exchangeable „Vario“ handle

automatic locking mechanism ensures that blades do not fall out unexpectedly, ergonomically formed 2 component book of PP/TPE material



Art. no.	TL	shank	kg	PU
102040	120	hexagonal	0,058	1

„Vario“ screw cap

Additional screw cap when using as precision tool (electronics)



Art. no.	TL	kg	PU
102044	10	0,002	1

„Vario“ 1000 V replaceable blade

Insulated replaceable blade made from molybdenum vanadium steel, hardened, blasted, with hexagonal shaft, greater torque transmission than a pure pozidrive or slotted blade



„Vario“ replaceable blade – pozidrive blade/slotted

Art. no.	form	size	BL	TL	kg	PU
102010	PZ/FL	1	85	165	0,035	1
102012	PZ/FL	2	85	165	0,045	1



„Vario“ replaceable blade – slotted blade

Art. no.	form	CW	KSt	BL	TL	kg	PU
102014	SL	2,5	0,4	85	165	0,013	1
102016	SL	3,0	0,5	85	165	0,015	1
102017	SL	3,5	0,6	85	165	0,080	1
102018	SL	4,0	0,8	85	165	0,022	1
102020	SL	5,5	1,0	85	165	0,034	1
102022	SL	6,5	1,2	85	165	0,045	1



„Vario“ replaceable blade – Phillips blade

Art. no.	form	size	BL	TL	kg	PU
102001	PH	0	85	165	0,023	1
102002	PH	1	85	165	0,035	1
102004	PH	2	85	165	0,044	1



„Vario“ replaceable blade – pozidrive blade

Art. no.	form	size	BL	TL	kg	PU
102005	PZ	0	85	165	0,023	1
102006	PZ	1	85	165	0,035	1
102008	PZ	2	85	165	0,045	1



„Vario“ replaceable blade – torx blade

Art. no.	form	size	BL	TL	kg	PU
102060	S-TX	8	85	165	0,016	1
102062	S-TX	9	85	165	0,016	1
102064	S-TX	10	85	165	0,016	1
102066	S-TX	15	85	165	0,021	1
102068	S-TX	20	85	165	0,021	1
102070	S-TX	25	85	165	0,034	1
102072	S-TX	30	85	165	0,041	1

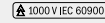

„Vario“ switch cabinet key – Square

Art. no.	size	TL	kg	PU
102030	6	47	0,010	1
102032	8	47	0,009	1

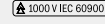

„Vario“ switch cabinet key – Triangular

Art. no.	size	TL	kg	PU
102034	9	47	0,009	1

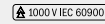

„Vario“ switch cabinet key – Double-bit

Art. no.	size	TL	kg	PU
102036	5,3	47	0,009	1

„Vario“ 1000 V replaceable blade system

„VarioPro“ 1000 V replaceable blade system



The „VarioPro“ replaceable blade system with insulated replaceable blades, switching cabinet key is integrated into the system, VDE pliers set and voltage tester.

Contents:

- Slot: 0.4 x 2.5 x 100, 0.5 x 3.0 x 100, 0.6 x 3.5 x 100, 0.8 x 4.0 x 100, 1.0 x 5.5 x 100, 1.2 x 6.5 x 100
- Phillips: 0 x 100, 1 x 100, 2 x 100
- Pozidriv: 0 x 100, 1 x 100, 2 x 100
- PZ/FL 1, PZ/FL 2
- Tx: 8 x 100, 9 x 100, 10 x 100, 15 x 100, 20 x 100, 25 x 100, 30 x 100
- Square: 8 x 47
- Double-bit: 5,3 x 47
- Screw cap, additional screw cap when using as precision tool (electronics)
- 2-component exchangeable handle: 120 mm
- Voltage testers VDE/GS: 100700, 125-250 V
- VDE 2C pliers: 211200*, 211204*, 211208*, 211214

*High leverage (high leverage pliers offer power saving of up to 50%)



Placeholders for torque handle



Art. no.	set	width	height	depth	kg	PU
102052	30-pieces	410	310	85	3,200	1

Tool case „ElectroCombo“

black plastic case with metal catch, complete tool set for electricians and network technicians, case: 490 x 375 x 100 mm

Contents:

- 2C-VDE combination pliers, 180 mm*
- 2C-VDE side cutters, 160 mm*
- 2C-VDE wire stripping pliers, 160 mm
- 2C-VDE long chain nose pliers, straight, 200 mm*
- Cable cutter 160 mm, coating-insulated
- Crimping pliers for end sleeves 0,5 - 16 mm²
- Set ball point allen keys 9-pcs., extra long
- 2C exchangeable „Vario“ handle
- „Vario“ replaceable blade - slotted blade 2.5, 3, 4, 5.5 mm
- „Vario“ replaceable blade - Phillips blade 1, 2
- „Vario“ replaceable blade - pozidrive blade 1, 2
- „Vario“ replaceable blade - pozidrive blade/slotted 1 + 2
- Voltage tester „Basic“, black
- Spanners for switch-cabinets „HUPkey“
- Utility knives
- Junior hacksaw 150 mm
- Electricians' chisels 10 x 250 mm
- Cabinet levels 230 mm
- Measuring tape, 5 m
- Reversible ratchet 1/4"
- Engineers' hammer, 300 g
- Extension 1/4" 100 mm
- Sockets 1/4" WS: 4, 4.5, 5, 5.5, 6, 7, 8, 9, 10, 11, 12, 13, 14 mm
- Ratchet screwdriver „FlexPlus“ for long bits
- 1/4" Bits 50mm HEX 2, 2.5, 3, 4, 5, 6
- 1/4" Bits 50mm PH 0, 1, 2, 3
- 1/4" Bits 50mm PZ 0, 1, 2, 3
- 1/4" Bist 50mm FD 3, 4, 5, 6
- 1/4" Bits 50mm TX 10, 15, 20, 25, 30, 40
- 1/4" Bits 50mm PZ/FL 1 + 2
- 1/4" SQ x 1/4" HEX adapter 50 mm
- Assortment box 160 x 115 x 40 mm

*High leverage (high leverage pliers offer power saving of up to 50%)



Art. no.	set	width	height	depth	kg	PU
104090 *	78-pieces	490	375	100	6,000	1

haupa®

...convincing solutions

INFO

Dynamometric screwdriver with replaceable blades

The new HAUPA 1000 V VarioTQ dynamometric screwdriver is characterised by its precision and functionality.

The ergonomic handles can be adjusted individually.

1. 1.0 - 6.0 Nm
2. 0.5 - 3.5 Nm

HAUPA offers all relevant blade tip profiles as individual items and in set form in a high-quality nylon case.

- torque can be set using a separate key
- scale value can easily be read off
- clearly perceptible and audible signal when the set torque is achieved
- torque accuracy according to EN ISO 6789:2013-10



VarioTQ 1000V

with hexagonal shaft



insulated replaceable blade made from molybdenum vanadium steel, hardened, blasted

Precisely adjustable torque

Two handle versions, also available individually:

Art. no. 102790
1.0 - 6.0 Nm

Art. no. 102792
0.5 - 3.5 Nm

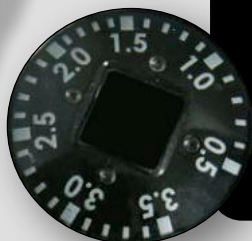

„VarioTQ“ 1000 V replaceable blade system

„VarioTQ“ 1000 V dynamometric screwdriver with replaceable blades - Phillips / Pozidriv

VarioTQ

NEW

insulated replaceable blade made from molybdenum vanadium steel, hardened, blasted, with hexagonal shaft, in robust nylon bag (with belt loop and hook and loop closure)

Contents:

- 2-component exchangeable handle (1000 V) 1 - 6 Nm or 0,5 - 3,5 Nm
- slotted 0,4 x 2,5 / 0,5 x 3,0 / 0,8 x 4,0 / 1,0 x 5,5 / 1,2 x 6,5
- PH0 / PH1 / PH2 or PZ0 / PZ1 / PZ2
- PZ/FL 1
- PZ/FL 2
- Square socket key



PREMIUM



Video 102700

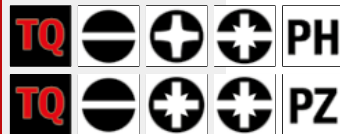

Art. no.	form	Nm	set	kg	PU
102700-1	PH	1 - 6	12 pieces	0,700	1
102701-1	PH	0,5 - 3,5	12 pieces	0,700	1
102700/PZ-1	PZ	1 - 6	12 pieces	0,700	1
102701/PZ-1	PZ	0,5 - 3,5	12 pieces	0,700	1

Art. no.	nylon bag	width	height	depth	kg	PU
102785-1	empty	300	145	35	0,130	1

„VarioTQ“ 1000 V replaceable blade system

NEW

„VarioTQ“ 1000 V dynamometric screwdriver with replaceable blades - Tx / Hex

VarioTQ

insulated replaceable blade made from molybdenum vanadium steel, hardened, blasted, with hexagonal shaft, in robust nylon bag (with belt loop and hook and loop closure)

Contents:

- 2-component exchangeable handle (1000 V) 1 - 6 Nm or 0,5 - 3,5 Nm
- TX 8 - 9 - 10 - 15 - 20 - 25 - 30 or TX 8 - 9 - 10 - 15 - 20, HEX 4 - 5
- PZ/FL 1
- PZ/FL 2
- Square socket key

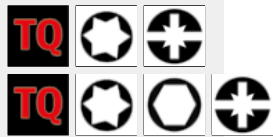

Art. no.	form	Nm	set	kg	PU
102702-1	TX	1 - 6	11-pieces	0,700	1
102703-1	TX	0,5 - 3,5	11-pieces	0,700	1
102706-1	TX+HEX	1 - 6	11-pieces	0,760	1
102707-1	TX+HEX	0,5 - 3,5	11-pieces	0,760	1

NEW

„VarioTQ“ 1000 V dynamometric screwdriver with replaceable blades - Hex

VarioTQ

insulated replaceable blade made from molybdenum vanadium steel, hardened, blasted, with hexagonal shaft, in robust nylon bag (with belt loop and hook and loop closure)

Contents:

- 2-component exchangeable handle (1000 V) 1 - 6 Nm or 0,5 - 3,5 Nm
- HEX 2 - 3 - 3,5 - 4 - 4,5 - 5 - 5,5 mm
- PZ/FL 1
- PZ/FL 2
- Square socket key



Art. no.	form	Nm	set	kg	PU
102704-1	HEX	1 - 6	11-pieces	0,700	1
102705-1	HEX	0,5 - 3,5	11-pieces	0,700	1

Torque screwdriver for a proper screw connection

- The use of tightening torques is a prerequisite for manufacturer-compliant fastening with type-tested switchgear.
- Screws are tightened neither too much, nor too little. Thus an increased transfer resistance and the emergence of glowing contacts are prevented.
- **NO FIRE HAZARD**

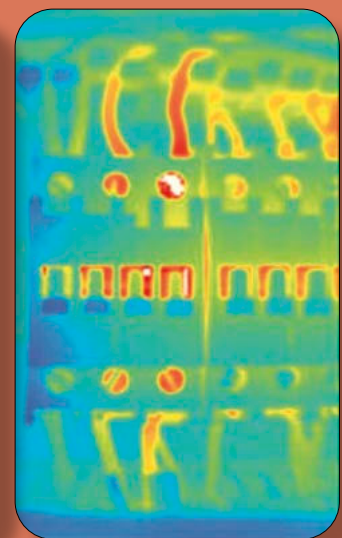

haupa®

...convincing solutions

„VarioTQ“ 1000 V replaceable blade system

Exchangeable „VarioTQ“ 1000 V handle



automatic locking mechanism ensures that blades do not fall out unexpectedly, ergonomically formed 2 component book of PP/TPE material, precisely adjustable torque

1000 V IEC 60900



Art. no.	TL	Nm	kg	PU
102790	122	1 - 6	0,185	1
102792	122	0,5 - 3,5	0,185	1

Square socket key

for adjustment of the torque for VarioTQ replacement blades



Art. no.	form	BL	KlBr	kg	PU
102784	SQ	40	8	0,056	1

Exchangeable „Vario“ handle

automatic locking mechanism ensures that blades do not fall out unexpectedly, ergonomically formed 2 component book of PP/TPE material

1000 V IEC 60900



Art. no.	TL	shank	kg	PU
102040	120	hexagonal	0,058	1

„VarioTQ“ 1000 V replaceable blade

Insulated replaceable blade made from molybdenum vanadium steel, hardened, blasted, individually tested with hexagonal shaft

1000 V IEC 60900



„VarioTQ“ 1000 V replaceable blade – pozidrive blade/slotted

Art. no.	form	size	BL	TL	kg	PU
102780	PZ/FL	1	195	195	0,040	1
102782	PZ/FL	2	195	195	0,040	1

1000 V IEC 60900



„VarioTQ“ 1000 V replaceable blade – slotted blade

Art. no.	form	CW	KSt	BL	TL	kg	PU
102710	SL	2,5	0,4	195	195	0,040	1
102712	SL	3,0	0,5	195	195	0,040	1
102714	SL	4,0	0,8	195	195	0,040	1
102716	SL	5,5	1,0	195	195	0,040	1
102718	SL	6,5	1,2	195	195	0,040	1

1000 V IEC 60900



„VarioTQ“ 1000 V replaceable blade – Phillips blade

Art. no.	form	size	BL	TL	kg	PU
102720	PH	0	195	195	0,040	1
102722	PH	1	195	195	0,040	1
102724	PH	2	195	195	0,040	1
102726	PH	3	195	195	0,040	1

1000 V IEC 60900



„VarioTQ“ 1000 V replaceable blade – pozidrive blade

Art. no.	form	size	BL	TL	kg	PU
102730	PZ	0	195	195	0,040	1
102732	PZ	1	195	195	0,040	1
102734	PZ	2	195	195	0,040	1
102736	PZ	3	195	195	0,040	1

1000 V IEC 60900



„VarioTQ“ 1000 V replaceable blade – torx blade

Art. no.	form	size	BL	TL	kg	PU
102740	TX	8	195	195	0,040	1
102742	TX	9	195	195	0,040	1
102744	TX	10	195	195	0,040	1
102746	TX	15	195	195	0,040	1
102748	TX	20	195	195	0,040	1
102750	TX	25	195	195	0,040	1
102752	TX	30	195	195	0,040	1

1000 V IEC 60900



„VarioTQ“ 1000 V replaceable blade – hex blade

Art. no.	form	size	BL	TL	kg	PU
102760	HEX	2	195	195	0,040	1
102762	HEX	3	195	195	0,040	1
102764	HEX	3,5	195	195	0,040	1
102766	HEX	4	195	195	0,040	1
102768	HEX	4,5	195	195	0,040	1
102770	HEX	5	195	195	0,040	1
102772	HEX	5,5	195	195	0,040	1

INFO

2 component pliers

Industrial quality

HAUPA divides the VDE pliers assortment into three groups.

1. 2C VDE pliers with plug-on handles
2. VDE pliers, coating-insulated, treated with a 2-coloured coating-isolation (outside red/inside yellow)
3. VDE pliers with a 2-coloured coating-isolation (outside red/inside yellow), working head insulated

These pliers fulfil the VDE standard IEC 60900.

High leverage | perfected cutting force performance

High leverage pliers offer power saving of up to 50%.



Combination pliers DIN ISO 5746 VDE

german pattern, comfort grip, alloyed carbon steel, C 45, oil-hardened, cutting edges induction hardened, for soft and hard wire, chrome plated, sheathed handles, **leveraged, perfected cutting force performance.**



Art. no.	TL		kg	PU
211198	160	IEC 60900	0,000	1
211200 *	180	VDE	0,287	1
211202	200	VDE	0,364	1

Side cutters DIN ISO 5749 VDE

swedish pattern, high alloyed carbon steel, oil-hardened, C 60, cutting edges induction hardened, for soft and hard wire, chrome plated, sheathed handles, **leveraged, perfected cutting force performance.**



Art. no.	TL		kg	PU
211199	140	IEC 60900	0,000	1
211204 *	160	VDE	0,237	1
211206	180	VDE	0,296	1

Side cutting pliers with stripping function VDE

Swedish design, power class H, C 60, oil-hardened, induction hardened blades, for hard and soft wire, chrome plated, push-on grips. Aside from their traditional advantages, these side cutting pliers also possess an additional wire stripping function. (art. 211207, **leveraged, perfected cutting force performance.**)



Art. no.	TL		kg	PU
211203	160	VDE	0,296	1
211207	180	VDE	0,296	1

Wire stripping pliers VDE

C 45, oil-hardened, with spring and adjustment screw, for cable of 0,2 - 6 mm Ø, chrome plated, sheathed handles



Art. no.	TL		kg	PU
211214 *	160	VDE	0,202	1

Heavy duty side cutters DIN ISO 5745 VDE

C 60, cutting edges induction hardened, chrome plated, sheathed handles, **leveraged, perfected cutting force performance.**



Art. no.	TL		kg	PU
211211	160	IEC 60900	0,000	1
211217 *	170	VDE	0,268	1

Heavy duty side cutters DIN ISO 5749 VDE

C 60, cutting edges induction hardened, chrome plated, sheathed handles, **leveraged, perfected cutting force performance.**



Art. no.	TL		kg	PU
211219 *	200	VDE	0,322	1

Long chain nose pliers DIN ISO 5745 VDE

with side cutter, straight, C 45, oil-hardened, cutting edges induction hardened, for soft and hard wire, chrome plated, sheathed handles, **leveraged, perfected cutting force performance.**



Art. no.	TL		kg	PU
211213	160	- IEC 60900	0,000	1
211208 *	200	- VDE	0,255	1

Long chain nose pliers DIN ISO 5745 VDE, 45°

with side cutter, 45° angled nose, C 45, oil-hardened, cutting edges induction hardened, for soft and hard wire, chrome plated, sheathed handles, **leveraged, perfected cutting force performance.**



Art. no.	TL		kg	PU
211209	160	45° IEC 60900	0,000	1
211210	200	45° VDE	0,260	1

haupa

...convincing solutions

VDE pliers, sheathed handles 1000 V

Short flat nose pliers DIN ISO 5745 VDE

C 45, oil-hardened, chrome plated, short body, sheathed handles



Art. no.	TL		kg	PU
211212	160	VDE	0,168	1

Short round nose pliers DIN ISO 5745 VDE

C 45, alloyed carbon steel, oil-hardened, chrome plated, sheathed handles



Art. no.	TL		kg	PU
211216	160	VDE	0,161	1

Water pump pliers DIN ISO 8976 VDE

self-clamping water pump plier with head adjustment, non-slip, chrome plated, sheathed handles



Art. no.	TL		kg	PU
211221	240	VDE	0,392	1

Cable cutters VDE

- For cutting Cu/Al cables, fine and multi-wiring
- Chrome vanadium steel, plug-on handles
- Insulating function in upper head area
- Cable measuring function thanks to the 180 degree crossover of the legs
- Not for solid conductors

Art. 211225 (Art. 211223)

- Data, telephone and control cable, maximum Ø 10 mm (Ø 12 mm)
- Cu single wire, maximum 16 mm² (16 mm²)
- Cu fine wire, maximum 16 mm² (35 mm²)
- Cu multi-wire, maximum 16 mm² (25 mm²)
- Al single wire, maximum 16 mm² (25 mm²)
- Al multi-wire, maximum Ø 10 mm = 16 mm² (25 mm²)

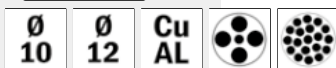

Art. no.	TL	Ø	mm ²	kg	PU	
211225 *	160	10	16	VDE	0,215	1
211223	200	12	35	VDE	0,352	1

Cable cutters VDE with spring joint

- For cutting Cu/Al cables, fine and multi-wiring
- Not suitable for steel wire and wire rope
- Chrome vanadium steel
- Self-opening joint spring
- Enormous cutting power with reduced force expenditure
- Not for solid conductors



Art. no.	TL	Ø	mm ²	kg	PU	
211226	170	10	25	VDE	0,268	1
211228 *	230	15	70	VDE	0,457	1



Pliers set 1000 V, sheathed handles

with VDE-safety-isolation, best quality, pliers chrome plated, 4-pieces.

Contents:

- Combination pliers 180 mm
- Side cutter 160 mm
- Long chain nose pliers 200 mm
- Wire stripping pliers 160 mm



Art. no.	set	kg	PU	
220123 *	4-pieces	VDE	1,063	1



Fully insulating 1000 V PVC flat nose pliers

all of plastic, specially for mounting and blocking of electric meters

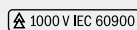

Art. no.	TL	kg	PU
120051	190	0,109	1

Flat nose pliers 1000 V

all of plastic, specially for mounting and blocking of electric meters

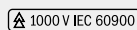

Art. no.	TL	kg	PU
120052	160	0,084	1

VDE-pliers, 2-coloured coating-insulation 1000 V

Combination pliers DIN ISO 5746 VDE

alloyed carbon steel, C 45, oil-hardened, cutting edges induction hardened, for soft and hard wire, german pattern, chrome plated, 2-coloured coating-insulation - inside yellow/outside red



Art. no.	TL	kg	PU
210056	180	0,300	1
210058	200	0,418	1

Side cutters DIN ISO 5749 VDE

swedish pattern, high alloyed carbon steel, oil-hardened, C 60, cutting edges induction hardened, for soft and hard wire, chrome plated, 2-coloured coating-insulation - inside yellow/outside red



Art. no.	TL	kg	PU
210100	160	0,253	1
210102	180	0,303	1

Side cutters DIN ISO 5749 VDE

swedish pattern, high alloyed carbon steel, oil-hardened, C 60, cutting edges induction hardened, for soft and hard wire, chrome plated, 2-coloured coating-insulation - inside yellow/outside red



Art. no.	TL	kg	PU
210110	240	0,489	1
210117	180	0,274	1
210119	200	0,368	1

Front cutters 1000 V

alloyed carbon steel, cutting edges induction hardened, chrome plated, 2-coloured coating-insulation - inside yellow/outside red



Art. no.	TL	kg	PU
210303	160	0,328	1

Long chain nose pliers DIN ISO 5745 VDE

alloyed carbon steel, C 45, oil-hardened, cutting edges induction hardened, for any wire, chrome plated, 2-coloured coating-insulation - inside yellow/outside red



Art. no.	TL	kg	PU
210388	200	0,270	1

Long chain nose pliers DIN ISO 5745 VDE, 45°

alloyed carbon steel, C 45, oil-hardened, cutting edges induction hardened, for any wire, chrome plated, 2-coloured coating-insulation - inside yellow/outside red



Art. no.	TL	kg	PU
210390	200	0,256	1

Short round nose pliers DIN ISO 5745 VDE

C 45, alloyed carbon steel, oil-hardened, chrome plated, 2-coloured coating-insulation - inside yellow/outside red



Art. no.	TL	kg	PU
210296	160	0,180	1

Short flat nose pliers DIN ISO 5745 VDE

C 45, alloyed carbon steel, oil-hardened, chrome plated, 2-coloured coating-insulation - inside yellow/outside red



Art. no.	TL	kg	PU
210270	160	0,187	1

haupa[®]

...convincing solutions

HAUPA GmbH & Co. KG, Koenigstr. 165-169, 42853 Remscheid, Phone: +49 (0)2191 8418-0, Fax: +49 (0)2191 8418-840, sales@haupa.com

VDE-pliers, 2-coloured coating-insulation 1000 V

Wire stripping pliers VDE

C 45, oil-hardened, with spring and adjustment screw, for cable of 0,2 - 6 mm Ø, chrome plated, 2-coloured coating-insulation - inside yellow/outside red



Art. no.	TL	kg	PU
210648	160	0,232	1

Water pump pliers DIN ISO 8976 1000 V

heavy pattern, made of chrome vanadium steel, with roll, chrome plated, 2-coloured coating-insulation - inside yellow/outside red



Art. no.	TL	kg	PU
210588	260	0,590	1

Water pump pliers DIN ISO 8976 1000 V

chrome vanadium, 31 Cr V3, box-joint, burner hole, teeth induction hardened, finger protection, oil-hardened, 2-coloured coating-insulation - inside yellow/outside red



Art. no.	TL	kg	PU
210583	240	0,423	1

Cable cutters 1000 V with spring joint

- For cutting Cu/Al cables, fine and multi-wiring
- Not suitable for steel wire and wire rope
- Chrome vanadium steel
- Self-opening joint spring
- Enormous cutting power with reduced force expenditure
- Not for solid conductors

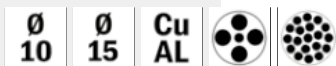

Art. no.	TL	Ø	mm ²	kg	PU
200086/VDE	205	10	25	0,274	1
200088/VDE	230	15	70	0,479	1

Pliers set 1000 V, 2-coloured coating-insulation

C 45, oil-hardened, 2-coloured coating-insulation - inside yellow/ outside red. Pliers chrome plated, 4-pieces.

Contents:

- Combination pliers 180 mm
- Diagonal cutters 160 mm
- Long chain nose pliers, straight 200 mm
- Wire stripping pliers 160 mm



Art. no.	set	kg	PU
220126	4-pieces	1,000	1

Tool case „Real“ 1000 V

made of plastic, complete with 20 security tools. Dimension: 450 x 340 x 100 mm.

Contents:

- 2C-VDE electrician's screwdrivers 2,5 x 75, 4 x 100, 6,5 x 150, 8 x 175
- 2C-VDE cross slotted screwdrivers PH, size 0, 1, 2
- 2C-VDE socket wrenches 5, 8, 10, 13 mm
- VDE combination pliers 200 mm
- VDE side cutters 180 mm
- VDE telephone pliers, straight 200 mm
- VDE wire stripping pliers 160 mm
- VDE flat nose pliers 160 mm
- VDE round nose pliers 160 mm
- Cable knife
- Cable stripping knife
- 2-pole voltage tester



Art. no.	set	kg	PU
220148	20-pieces	4,300	1

VDE pliers, coating-insulated 1000 V, head insulated

Combination pliers DIN ISO 5746 1000 V

working head insulated, 2-coloured coating-insulation - inside yellow/outside red

⚠ 1000 V IEC 60900



Art. no.	TL	kg	PU
210263	180	0,306	1
210264	200	0,372	1

Side cutters DIN ISO 5749 1000 V

working head insulated, 2-coloured coating-insulation - inside yellow/outside red

⚠ 1000 V IEC 60900



Art. no.	TL	kg	PU
210301	160	0,270	1
210302	180	0,309	1

Long chain nose pliers DIN ISO 5745 1000 V

straight, working head insulated, 2-coloured coating-insulation - inside yellow/outside red

⚠ 1000 V IEC 60900



Art. no.	TL	kg	PU
210266	160	0,182	1
210267	200	0,236	1

Long chain nose pliers DIN ISO 5745 1000 V, 45°

angled nose, working head insulated, 2-coloured coating-insulation - inside yellow/outside red

⚠ 1000 V IEC 60900



Art. no.	TL	kg	PU
210297	200	0,228	1

Plan grip pliers 1000 V

working head insulated, made of special alloy steel, long, flat, plain gripping jaws, round edges, 2-coloured coating-insulation - inside yellow/outside red

⚠ 1000 V IEC 60900



Art. no.	TL	kg	PU
210298	200	0,215	1

Short flat nose pliers DIN ISO 5745 1000 V

working head insulated, 2-coloured coating-insulation - inside yellow/outside red

⚠ 1000 V IEC 60900



Art. no.	TL	kg	PU
210299	160	0,216	1

Long chain nose pliers DIN ISO 5745 1000 V

working head insulated, 2-coloured coating-insulation - inside yellow/outside red

⚠ 1000 V IEC 60900



Art. no.	TL	kg	PU
210300	160	0,191	1

Wire stripping pliers 1000 V

working head insulated, 2-coloured coating-insulation - inside yellow/outside red

⚠ 1000 V IEC 60900



Art. no.	TL	kg	PU
210265	160	0,180	1



haupa[®]

...convincing solutions

HAUPA GmbH & Co. KG, Koenigstr. 165-169, 42853 Remscheid, Phone: +49 (0)2191 8418-0, Fax: +49 (0)2191 8418-840, sales@haupa.com

Cable cutters, stripping pliers 1000 V

Cable cutter 1000 V

Grave version of vanadium steel, annealed, opening 15 mm, 2-coloured coating-insulation - inside yellow/outside red



1000 V IEC 60900



Art. no.	TL	Ø	mm ²	kg	PU
200127	160	15	50	0,289	1

Cable cutter 1000 V

Long version, slight strain, one and two hand handling, proper cutting due to precise grind, forged of special carbon-steel, 2-coloured coating-insulation - inside yellow/outside red



1000 V IEC 60900



Art. no.	TL	Ø	mm ²	kg	PU
200129	240	15	50	0,484	1

Cable cutter with a snap 1000 V

Laser-cut components made of special carbon steel, oil-hardened, for optimal precision, CNC-ground cutting type, inductively hardened for maximum cutting performance, Screwed joint connections, re-adjustable for longer durability as well as, 2-coloured coating-insulation - inside yellow/outside red, for cables to 16,9 mm Ø (70 mm²)



1000 V IEC 60900

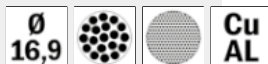

Art. no.	TL	Ø	mm ²	kg	PU
201002/VDE	180	16,9	70	0,247	1

Cable cutter 1000 V

of carbon-steel, maximum cutting capacity due to special cutting-geometry, with VDE insulation, 2-coloured coating-insulation - inside yellow/outside red



1000 V IEC 60900

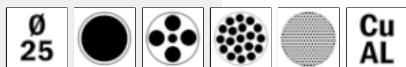

Art. no.	TL	Ø	mm ²	kg	PU
200120	215	25	70	0,403	1

Allround soft-grip scissors VDE

The new allround Soft - Grip scissors with its relatively short blades and special handles are designed to fulfil the needs of the professional electrical installers. The impressive cutting performance and the tough construction make this new scissors a special tool.

- ergonomic design (2 component)
- slipping free handle - Soft - Grip
- high cutting performance by low cutting force
- precision tothing
- cable stripping device
- stainless



1000 V IEC 60900



Art. no.	TL	mm ²	kg	PU
200201	160	70	0,083	1

Double edged cable cutter 1000 V

slight strain due to optimal lever-transmission, edges with precise grind for easy and proper cutting by one hand handling, opening 20 mm, forged of special carbon-steel, for copper and alu-cable, 2-coloured coating-insulation - inside yellow/outside red



1000 V IEC 60900



Art. no.	TL	Ø	mm ²	kg	PU
200128	200	20	50	0,382	1

Cable cutters 1000 V

VDE ratchet cable cutter with cover 1000 V

One-hand cable cutter with ratchet, optimal lever-transmission, encapsulated head, for copper and alu-cable, opening 25 mm, 2-coloured coating-insulation - inside yellow/outside red



⚠ 1000 V IEC 60900

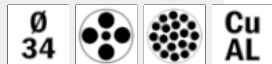

Art. no.	TL	Ø	mm ²	kg	PU
200109	290	34	240	1,308	1

Cable cutter 1000 V

- For cutting Cu/Al cables, fine and multi-wiring
- Not suitable for steel wire and wire rope
- Low force required thanks to best blade geometry and translation ratios
- Vanadium electro-steel, forged, oil-hardened
- Aluminium legs
- Hardened blades with precision grinding
- Adjustable screw joint



⚠ 1000 V IEC 60900



Art. no.	TL	Ø	mm ²	kg	PU
200123	500	27	150	1,389	1

Ratchet cable cutter 1000 V

Extremely durable special steel, single-handed operation, stepped cutting in gradation-free cut for copper and aluminium cable



⚠ 1000 V IEC 60900

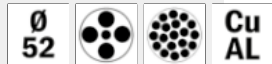

Art. no.	Ø	mm ²	kg	PU
200198	52	400	0,942	1

Ratchet cable cutter 1000 V

Two-handed cutter with dual bearing offset mechanism, almost break-proof meshing of rotating blade and tooth blade, separates multiple and fine-wired copper and aluminium cables up to a diameter of 62 mm or 80 mm, but also separates cables with thin steel sheet sleeve or steel sheet armoring in the outer part of the cable, not for hardened steel



⚠ 1000 V IEC 60900

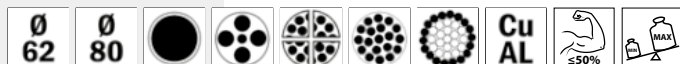

Art. no.	Ø	mm ²	kg	PU
200193	62	840	2,200	1
200195	80	1000	3,150	1

Cable cutters 1000 V

- For cutting Cu/Al cables, fine and multi-wiring
- Not suitable for steel wire and wire rope
- Hardened blades with precision grinding
- Dual lever ensures easy cutting
- Adjustable screw joint
- Blade head in chrome vanadium steel, forged and oil-hardened



⚠ 1000 V IEC 60900



Art. no.	TL	Ø	mm ²	kg	PU
200110	600	26	150	2,327	1
200141	700	33	185	3,292	1

	single wire		wire rope
	multi-wire		armoured steel cable
	sector-shaped		ACSR
	fine wire		bolt
	communication		solid steel
			solid Cu

haupa[®]

...convincing solutions

Wire cutters 1000 V

Wire rope and cable cutter 1000 V

with lever action, blades of high alloyed interchangeable, cutting capacity steelaluminum ropes up to 16 mm², for copper- and aluminum cable, opening approx 9 mm

1000 V IEC 60900

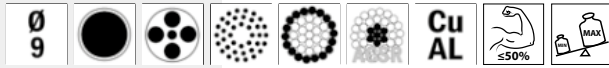

Art. no.	TL	Ø	mm ²	kg	PU
200081	700	9	16	2,880	1
200081/MK	Spare cutting head			0,350	1

Wire rope and cable cutter 1000 V

without transmission, blades of high quality special steel, forged, replaceable, opening 20 mm, insulated. Working range: steel-aluminum rope up to 120 mm², copper- and aluminum cable

1000 V IEC 60900

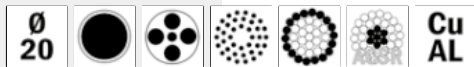

Art. no.	TL	Ø	mm ²	kg	PU
200130	600	20	120	2,348	1
200132	Spare cutting head			0,340	1

	single wire		wire rope
	multi-wire		armored steel cable
	sector-shaped		ACSR
	fine wire		bolt
	communication		solid steel
			solid Cu

Hacksaw frames 1000 V

Hacksaw frame 1000 V

fully insulated, 2-coloured coating-insulation - inside yellow/outside red

1000 V IEC 60900



Art. no.	TL	Sbl.	kg	PU
110558	200	150	0,248	1

Hacksaw frame 1000 V

fully insulated, 2-coloured coating-insulation - inside yellow/outside red

1000 V IEC 60900



Art. no.	TL	Sbl.	strength	kg	PU
110559	350	300	18 x 8	0,732	1

Cable sheath strippers 1000 V

Stripping pliers 1000 V

full insulated, for cutting and stripping off cable sheaths of PVC, PE and VPE, limited cutting deep and therefore no damage on the inside conductors, easy handling, 2-coloured coating-insulation - inside yellow/outside red

1000 V IEC 60900



Art. no.	TL	Ø	kg	PU
200149	200	26 - 52	0,739	1

Cable sheath cutter 1000 V

for removing all insulating layers from cables with diameters as of 25 mm

- Replaceable dual blade
- Cutting depth can be set
- Suitable for lengthwise and circular cuts

1000 V IEC 60900



Video 110561_67



Art. no.	Ø	kg	PU
110561	>25	0,250	1
110569	spare blades		0,040 1

VDE cable knives 1000 V

Cable knife VDE

with a straight, strong blade, handles made from tough elastic, impact proof plastic, with transparent blade guard



Art. no.	BL	form	kg	PU
200000 *	50	straight	0,110	1

Cable knife VDE

with a hook-shaped blade, handles made from tough elastic, impact proof plastic, with blade guard, thumb recess at the front and finger hook at the end of the handle. **Application:** Round cable



Art. no.	BL	form	kg	PU
200002 *	35	straight	0,093	1

Cable knife VDE

with a hook-shaped insulated blade, handles made from tough elastic, impact proof plastic, with blade guard. **Application:** Large round cables



Art. no.	BL	form	kg	PU
200003	35	sickle	0,074	1

Cable knife VDE

with a curved blade, handles made from tough elastic, impact proof plastic, with blade guard. **Application:** Sector cable



Art. no.	BL	form	kg	PU
200004	35	hooked	0,087	1

Cable knife VDE

with a straight, partially-insulated, strong blade, handles made from tough elastic, impact proof plastic, with blade guard. **Application:** To prevent short circuiting



Art. no.	BL	form	kg	PU
200005	40	straight	0,106	1

Cable knife VDE with sliding block

with a hook blade for slicing open and removing the sleeve from wet-room cables, handles made from tough elastic, impact proof plastic, with transparent blade guard. **Application:** Wet-room cables, no damage to conductor insulation thanks to sliding block



Art. no.	BL	form	kg	PU
200007	50	sickle	0,120	1

Cable knife VDE

with a straight, partially-insulated, strong blade, handles made from tough elastic, impact proof plastic, replaceable blades, fixed blade guard. **Application:** To prevent short circuiting



Art. no.	BL	form	kg	PU
201010 *	50	straight	0,067	1

Replacement blades, 4-pcs.

suitable for article 201010

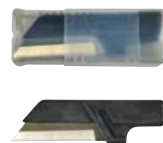

Art. no.	BL	form	kg	PU
201012	50	straight	0,087	1

Cable stripping knife VDE

with curved, strong blade, handles made from tough elastic, impact proof plastic, with blade guard. **Application:** Rubberised insulation types



Art. no.	BL	form	kg	PU
200009	50	straight	0,094	1

Cable stripping knife VDE

Blade with a slim, straight blade for fine tasks, handles made from tough elastic, impact proof plastic, with blade guard. **Application:** Phases



Art. no.	BL	form	kg	PU
200013	50	straight	0,094	1

haupa

...convincing solutions

T-Handle socket wrenches 1000 V

chrome vanadium steel, full insulated, for hexagon nuts, DIN 7440, 2-coloured coating-insulation - inside yellow/outside red

 1000 V IEC 60900



Art. no.	WS	BL	handle	kg	PU
110000	10	200	160	0,300	1
110002	11	200	160	0,315	1
110004	12	200	160	0,320	1
110006	13	200	160	0,320	1
110008	14	200	160	0,426	1
110010	17	200	160	0,401	1
110012	19	200	160	0,430	1
110022	11	300	160	0,429	1
110024	12	300	160	0,375	1
110026	13	300	160	0,380	1
110028	14	300	160	0,385	1
110030	17	300	160	0,534	1
110032	19	300	160	0,556	1
110034	22	300	160	0,662	1
110036	24	300	160	0,990	1

Cross type socket wrenches 1000 V

chrome vanadium steel, no contact with steel insert, full insulated, 2-coloured coating-insulation - inside yellow/outside red

 1000 V IEC 60900



Art. no.	WS	BL	kg	PU
110070	10-11-14-17	200	0,451	1
110074	11-12-13-17	200	0,225	1
110076	10-13-14-17	200	0,455	1
110078	11-13-14-17	200	0,449	1
110080	13-17-19-22	200	0,502	1

Counter hold spanners 1000 V

chrome vanadium steel (31 CrV 3), 2-coloured coating-insulation - inside yellow/outside red

 1000 V IEC 60900



Art. no.	WS	TL	kg	PU
110081	10	200	0,118	1
110083	12	200	0,120	1
110084	13	200	0,140	1
110085	14	250	0,150	1
110087	16	260	0,249	1
110089	17	270	0,255	1
110091	18	265	0,250	1
110093	19	270	0,275	1
110095	20	275	0,300	1
110097	22	275	0,300	1
110099	24	270	0,350	1

Right angle allen keys 1000 V

chrome vanadium steel, for hexagon socket screws, full insulated, 2-coloured coating-insulation - inside yellow/outside red

 1000 V IEC 60900



Art. no.	WS	kg	PU
110042	3	0,016	1
110044	4	0,029	1
110046	5	0,045	1
110048	6	0,051	1
110050	8	0,103	1
110052	10	0,220	1
110054	12	0,352	1

T-handle allen keys 1000 V

chrome vanadium steel, for screws with hexagon inserts, full insulated, 2-coloured coating-insulation - inside yellow/outside red

 1000 V IEC 60900



Art. no.	WS	kg	PU
110060	5	0,222	1
110062	6	0,227	1
110064	8	0,224	1

Single ended spanners 1000 V

chrome vanadium steel, full insulated, offset at 15°, 2-coloured coating-insulation - inside yellow/outside red

 1000 V IEC 60900



Art. no.	WS	TL	strength	kg	PU
110260	6	75	3	0,021	1
110262	7	80	3,5	0,020	1
110264	8	85	3,5	0,032	1
110266	9	100	4	0,035	1
110268	10	120	5	0,035	1
110270	11	130	5,5	0,044	1
110272	12	140	5,5	0,064	1
110274	13	155	6	0,061	1
110276	14	170	6	0,084	1
110278	17	185	6,5	0,121	1
110280	19	210	7,5	0,140	1
110282	22	230	8,5	0,215	1
110284	24	250	9,5	0,242	1
110286	27	290	11,5	0,338	1
110288	30	345	13	0,390	1
110290	32	350	15	0,503	1

Single ended tool set acc. to VDE 1000 V

in tool wallet of black imitation leather. **Contents:** 8 single ended tools of chrom vanadium steel, offset at 15°, 2-coloured coating-insulation - inside yellow/outside red.

Populated with:

- Size of key 10, 11, 12, 13, 14, 17, 19, 22



Art. no.	set	empty	kg	PU
220017	8-pieces	220002	1,181	1

Ring spanners 1000 V

chrome vanadium steel, full insulated, offset at 75°, 2-coloured coating-insulation - inside yellow/outside red



Art. no.	WS	TL	kg	PU
110300	6	140	0,061	1
110302	7	140	0,066	1
110304	8	150	0,084	1
110306	9	155	0,066	1
110308	10	160	0,092	1
110310	11	170	0,089	1
110312	12	180	0,130	1
110314	13	195	0,132	1
110316	14	205	0,147	1
110318	17	240	0,233	1
110320	19	260	0,236	1
110322	22	280	0,345	1
110324	24	280	0,357	1

Ratchet ring spanners 1000 V

full insulated, 2-coloured coating-insulation - inside yellow/outside red



72 sprockets

Art. no.	WS	kg	PU
110870	8	0,032	1
110872	9	0,040	1
110874	10	0,050	1
110876	11	0,059	1
110878	12	0,065	1
110880	13	0,076	1
110882	14	0,086	1
110884	15	0,105	1
110886	16	0,130	1
110888	17	0,161	1
110890	18	0,179	1
110892	19	0,215	1

Adjustable wrenches to DIN 3117 A 1000 V

steel forged, 2-coloured coating-insulation - inside yellow/outside red

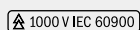

Art. no.	WS max.	TL	kg	PU
110555	26	200	0,325	1
110556	31	250	0,512	1
110557	36	300	0,809	1



haupa[®]

...convincing solutions

Reversible ratchet 1000 V

1/4"

full insulated, from shock-resistant plastic



Art. no.	drive	TL	kg	PU
220577	1/4"	150	0,145	1

Fittings for hexagon socket screws 1000 V

1/4"

1/4" square drive, made of chrome vanadium steel, forged, oil hardened, full insulated, from shock-resistant plastic



Art. no.	WS	drive	TL	kg	PU
220591	3	1/4"	55	0,016	1
220592	4	1/4"	55	0,012	1
220593	5	1/4"	55	0,012	1
220594	6	1/4"	55	0,024	1

Socket T-wrench 1000 V

1/4"

chrome vanadium steel, tempered, with locking device against accidental loosening of sockets or extensions, full insulated, from shock-resistant plastic



Art. no.	drive	TL	kg	PU
220578	1/4"	125	0,085	1

Extensions 1000 V

1/4"

with locking device against accidental loosening of sockets or extensions, full insulated, from shock-resistant plastic



Art. no.	drive	TL	kg	PU
220579	1/4"	100	0,050	1
220580	1/4"	150	0,070	1

Hexagon sockets 1000 V

1/4"

1/4" square drive, full insulated, from shock-resistant plastic



Art. no.	WS	drive	TL	kg	PU
220581	5	1/4"	40	0,011	1
220582	6	1/4"	40	0,011	1
220583	7	1/4"	40	0,012	1
220584	8	1/4"	40	0,013	1
220585	9	1/4"	40	0,014	1
220586	10	1/4"	40	0,014	1
220587	11	1/4"	40	0,017	1
220588	12	1/4"	40	0,018	1
220589	13	1/4"	40	0,021	1
220590	14	1/4"	40	0,023	1

Tool case 1000 V

1/4"

made of plastic, complete with 1/4" tools. The plastic material used for socket sets is guaranteed to pass -40°C impact tests. This guarantee that the insulation value will not be compromised due to impact. Dimension: 286 x 255 x 54 mm.

Contents:

- Reversible ratchet 150 mm, 1/4"
- T-slip-on-keys 125 mm, 1/4"
- Extension 100 and 150 mm, 1/4"
- Sockets 1/4", 5, 6, 7, 8, 9, 10, 11, 12, 13, 14 mm
- Dies for hexagon screws 1/4", 3, 4, 5, 6 mm



Video 220576



Art. no.	set	drive	kg	PU
220576	18-pieces	1/4"	1,250	1

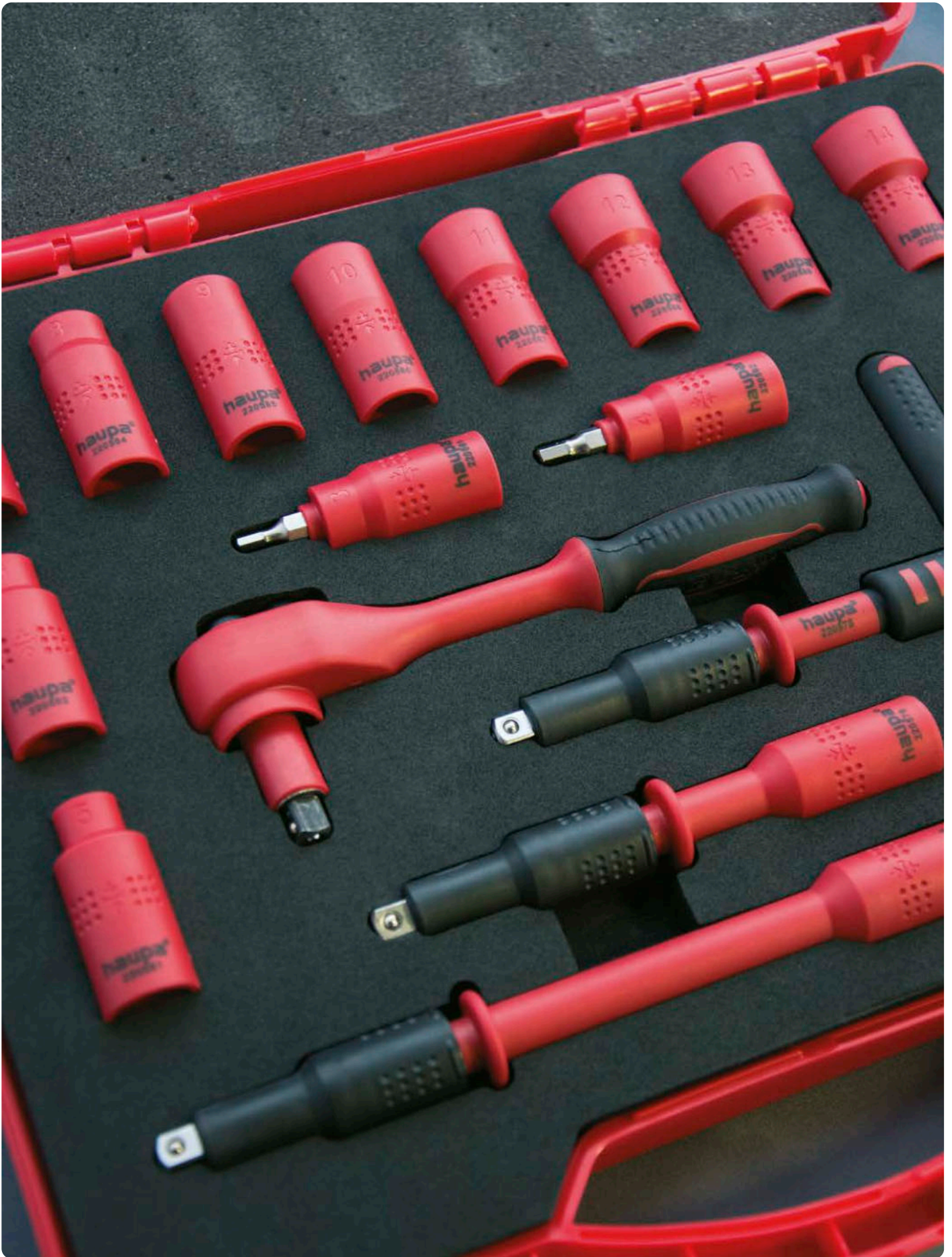

haupa[®]

...convincing solutions

HAUPA GmbH & Co. KG, Koenigstr. 165-169, 42853 Remscheid, Phone: +49 (0)2191 8418-0, Fax: +49 (0)2191 8418-840, sales@haupa.com

Reversible ratchet 1000 V

1/4"

fully insulated, 2-coloured coating-insulation - inside yellow/outside red

1000 V IEC 60900



Art. no.	drive	TL	kg	PU
110810	1/4"	135	0,122	1

Torque wrench 1000 V

TQ 1/4"

reversible ratchet system, fully insulated, 2-coloured coating-insulation - inside yellow/outside red

1000 V IEC 60900

TQ



Art. no.	drive	torque	TL	kg	PU
110812	1/4"	2-12	200	0,250	1
110813	1/4"	5-25	200	0,420	1

Socket T-wrench 1000 V

1/4"

chrome vanadium steel, tempered, with locking device against accidental loosening of sockets or extensions, full insulated, 2-coloured coating-insulation - inside yellow/outside red

1000 V IEC 60900



Art. no.	drive	TL	kg	PU
110818	1/4"	115	0,156	1

Extensions 1000 V

1/4"

with locking device against accidental loosening of sockets or extensions, full insulated, 2-coloured coating-insulation - inside yellow/outside red

1000 V IEC 60900



Art. no.	drive	TL	kg	PU
110814	1/4"	75	0,043	1
110816	1/4"	125	0,054	1

Extension with bit adapter 1000 V

1/4"

fully insulated, 2-coloured coating-insulation - inside yellow/outside red

1000 V IEC 60900



Art. no.	bit adapter	drive	TL	kg	PU
110860	1/4"	1/4"	40	0,023	1

Hexagon sockets 1000 V

1/4"

fully insulated, 2-coloured coating-insulation - inside yellow/outside red

1000 V IEC 60900



Art. no.	WS	drive	TL	kg	PU
110820	5	1/4"	25	0,012	1
110822	6	1/4"	25	0,012	1
110824	7	1/4"	25	0,014	1
110826	8	1/4"	25	0,011	1
110828	9	1/4"	25	0,016	1
110830	10	1/4"	25	0,014	1
110832	11	1/4"	25	0,020	1
110834	12	1/4"	25	0,021	1
110836	13	1/4"	25	0,021	1
110838	14	1/4"	25	0,034	1

Inserts for hexagon socket screws 1000 V

1/4"

fully insulated, 2-coloured coating-insulation - inside yellow/outside red

1000 V IEC 60900



Art. no.	WS	drive	kg	PU
110840	3	1/4"	0,010	1
110842	4	1/4"	0,014	1
110844	5	1/4"	0,014	1
110846	6	1/4"	0,015	1
110848	8	1/4"	0,021	1

Handles with bit adapter 1000 V

1/4"

fully insulated, 2-coloured coating-insulation - inside yellow/outside red

1000 V IEC 60900



Art. no.	bit adapter	drive	TL	kg	PU
110864	1/4"	1/4"	120	0,160	1
110866	1/4"	1/4"	160	0,248	1
110868	1/4"	1/4"	250	0,310	1

Tool case for household connections 1000 V

1/4"

Plastic case with foam insert, with 1/4" insert tools.
Dimensions: 450 x 340 x 100 mm.

Contents:

- 1 torque wrench 1/4" 5 - 25 Nm
- 3 extensions 1/4" 75 - 100 - 150 mm
- 2 bit holders 1/4" DIN 3126/FORM C 6,3
- 5 inserts 1/4" 6, 8, 10, 13, 14
- 10 hexagonal bits 5, 6, 8
- Slots 4, 5.5, 6.5
- PZ/FL 1, 2
- PH 1, 2

⚠ 1000 V IEC 60900



TQ

Art. no.	set	drive	kg	PU
110869	21-pieces	1/4"	1,000	1

Tool case 1000 V

1/4"

Plastic case with foam insert, with 1/4" insert tools.
Dimensions: 450 x 340 x 100 mm.

Contents:

- 1 ratchet 1/4"
- 1 bit holder 1/4"
- 1 T-fitting 1/4"
- 4 extensions 1/4"
- 10 inserts 1/4", 5, 6, 7, 8, 9, 10, 11, 12, 13, 14
- 5 hexagonal inserts 1/4" 3, 4, 5, 6, 8

⚠ 1000 V IEC 60900



Art. no.	set	drive	kg	PU
110871	22-pieces	1/4"	1,600	1

Reversible ratchet 1000 V

3/8"

full insulated, from shock-resistant plastic



Art. no.	drive	TL	kg	PU
220410	3/8"	200	0,300	1

Hexagon sockets 1000 V

3/8"

3/8" square drive, full insulated, from shock-resistant plastic



Art. no.	WS	drive	TL	kg	PU
220418	8	3/8"	44,5	0,027	1
220420	10	3/8"	44,5	0,027	1
220422	12	3/8"	44,5	0,029	1
220424	13	3/8"	44,5	0,032	1
220426	14	3/8"	44,5	0,035	1
220428	17	3/8"	44,5	0,047	1
220430	19	3/8"	46,0	0,051	1
220432	22	3/8"	46,0	0,063	1

Torque wrench 1000 V

TQ 3/8"

5 - 50 Nm, full insulated, from shock-resistant plastic. The achievement of the set torque is made noticeable by a clearly audible or tactile mechanism.

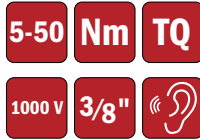

Art. no.	drive	Nm	TL	kg	PU
220415	3/8"	5 - 50	385	0,950	1

Fittings for hexagon socket screws 1000 V

3/8"

3/8" square drive, made of chrome vanadium steel, forged, oil hardened, full insulated, from shock-resistant plastic



Art. no.	WS	drive	TL	kg	PU
220434	4	3/8"	60,0	0,036	1
220436	5	3/8"	60,0	0,040	1
220438	6	3/8"	60,0	0,041	1
220440	8	3/8"	60,0	0,042	1

Socket T-wrench 1000 V

3/8"

chrome vanadium steel, tempered, with locking device against accidental loosening of sockets or extensions, full insulated, from shock-resistant plastic



Art. no.	drive	TL	kg	PU
220412	3/8"	200	0,241	1

Extensions 1000 V

3/8"

with locking device against accidental loosening of sockets or extensions, full insulated, from shock-resistant plastic



Art. no.	drive	TL	kg	PU
220414	3/8"	125	0,150	1
220416	3/8"	250	0,250	1

Tool case 1000 V

3/8"

made of plastic, complete with 3/8" tools. The plastic material used for socket sets is guaranteed to pass -40°C impact tests. This guarantee that the insulation value will not be compromised due to impact. Dimension: 286 x 255 x 54 mm.

Contents:

- Reversible ratchet 200 mm, 3/8"
- T-slip-on-keys 200 mm, 3/8"
- Extension 150 and 250 mm, 3/8"
- Sockets 3/8", 8, 10, 12, 13, 14, 17, 19, 22 mm
- Dies for hexagon screws 3/8", 4, 5, 6, 8 mm



Art. no.	set	drive	kg	PU
220402 *	16-pieces	3/8"	2,500	1



haupa®

...convincing solutions

HAUPA GmbH & Co. KG, Koenigstr. 165-169, 42853 Remscheid, Phone: +49 (0)2191 8418-0, Fax: +49 (0)2191 8418-840, sales@haupa.com

Reversible ratchet 1000 V

3/8"

full insulated, 2-coloured coating-insulation - inside yellow/outside red



Art. no.	drive	TL	kg	PU
110331/EN	3/8"	190	0,402	1

Locked torque wrench 1000 V

TQ 3/8"

reversible ratchet system, fixed factory-provided value, possible value between 5-27 Nm, value must be indicate before delivery, full insulated, 2-coloured coating-insulation - inside yellow/outside red. **Torque must be specified when ordering!**

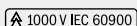

Art. no.	drive	Nm	TL	kg	PU
300310/EN	3/8"	5-27	280	0,951	1

Torque wrenches 1000 V

TQ 3/8"

reversible ratchet system, fully insulated, 2-coloured coating-insulation - inside yellow/outside red



Art. no.	drive	Nm	TL	kg	PU
110055/EN	3/8"	5-25	200	0,350	1
110056/EN	3/8"	5-25	280	0,920	1
110065/EN	3/8"	5-50	370	1,194	1

Torque T key 1000 V

TQ 3/8"

chrome vanadium steel, tempered, with locking device against accidental loosening of sockets or extensions, full insulated, 2-coloured coating-insulation - inside yellow/outside red

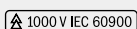

Art. no.	drive	Nm	TL	kg	PU
110071	3/8"	12	150	0,540	1
110073	3/8"	18	150	0,540	1
110075	3/8"	25	150	0,540	1

Torque stoppers 1000 V

TQ 3/8"

with short extension, locable for all sockets with 3/8" drive, full insulated, 2-coloured coating-insulation - inside yellow/outside red

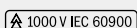

Art. no.	drive	Nm	kg	PU
110456/EN	3/8"	-12	0,220	1
110457/EN	3/8"	-18	0,220	1
110458/EN	3/8"	-25	0,224	1

Socket T-wrench 1000 V

3/8"

chrome vanadium steel, tempered, with locking device against accidental loosening of sockets or extensions, full insulated, 2-coloured coating-insulation - inside yellow/outside red



Art. no.	drive	BL	handle	kg	PU
110039/EN	3/8"	200	160	0,369	1

Extensions 1000 V

3/8"

with locking device against accidental loosening of sockets or extensions, full insulated, 2-coloured coating-insulation - inside yellow/outside red



Art. no.	drive	TL	kg	PU
110337/EN	3/8"	125	0,292	1
110335/EN	3/8"	250	0,280	1

Extensions with bit adapter 1000 V

3/8"

full insulated, 2-coloured coating-insulation - inside yellow/outside red



Art. no.	bit adapter	drive	TL	kg	PU
110861	1/4"	3/8"	125	0,137	1

Hexagon sockets 1000 V

3/8"

3/8" square drive, 4 edge drive, full insulated, 2-coloured coating-insulation - inside yellow/outside red



Art. no.	WS	drive	TL	kg	PU
110363/EN	8	3/8"	40	0,035	1
110364/EN	9	3/8"	40	0,032	1
110365/EN	10	3/8"	40	0,036	1
110366/EN	11	3/8"	40	0,037	1
110367/EN	13	3/8"	40	0,032	1
110368/EN	17	3/8"	40	0,050	1
110369/EN	19	3/8"	40	0,060	1
110371/EN	14	3/8"	40	0,070	1
110700/EN	12	3/8"	40	0,070	1
110702/EN	22	3/8"	40	0,061	1

Hexagon sockets 1000 V, extra long



3/8" square drive, 4 edge drive, full insulated, 2-coloured coating-insulation - inside yellow/outside red



Art. no.	WS	drive	TL	kg	PU
110710	10	3/8"	125	0,180	1
110712	12	3/8"	125	0,200	1
110713	13	3/8"	125	0,210	1
110714	14	3/8"	125	0,220	1
110715	17	3/8"	125	0,240	1
110716	19	3/8"	125	0,260	1
110717	22	3/8"	125	0,280	1

Fittings for hexagon socket screws 1000 V



3/8" square drive, 4 edge drive, made of chrome vanadium steel, forged, oil hardened, full insulated, 2-coloured coating-insulation - inside yellow/outside red



Art. no.	WS	drive	TL	kg	PU
300302/EN	4	3/8"	65	0,068	1
300296/EN	5	3/8"	65	0,065	1
300298/EN	6	3/8"	65	0,068	1
300299/EN	8	3/8"	65	0,070	1
300305/EN	10	3/8"	65	0,082	1

Tool case 1000 V



made of plastic, complete with 3/8" tools. Dimension: 450 x 340 x 100 mm.

Contents:

- Reversible ratchet 3/8"
- Extension 125 mm, 3/8"
- Extension 250 mm, 3/8"
- T-slip-on-keys 3/8"
- Sockets 3/8" (10, 11, 12, 13, 14, 17, 19, 22 mm)
- Dies for hexagon screws 3/8", 5, 6, 8 mm
- Torque stopper (12 to 25 Nm)
- 2C-VDE screwdriver 3,5 x 100 mm

with locking system



Art. no.	set	drive	kg	PU
220147	17-pieces	3/8"	3,400	1

Tool case 1000 V



made of plastic, complete with 3/8" tools. Dimension: 400 x 290 x 110 mm.

Contents:

- Reversible ratchet 3/8"
- Extension 125 mm, 3/8"
- Extension 250 mm, 3/8"
- T-slip-on-keys 3/8"
- Sockets 3/8", 8, 10, 13, 17, 19 mm
- Dies for hexagon screws 3/8", 4, 5, 6, 8 mm

without locking system



Art. no.	set	drive	kg	PU
220212	13-pieces	3/8"	2,500	1

Tool case 1000 V



Plastic case with foam insert, with 3/8" insert tools. Dimensions: 400 x 290 x 110 mm.

Contents:

- 1 torque wrench 3/8" 5-50 Nm
- 2 extensions 3/8" 125/250 mm
- 5 inserts, extra deep in the sizes 10, 13, 14, 17, 19 mm
- 5 inserts for hexagonal screws 3/8" in 4, 5, 6, 8, 10 mm
- Alignment tool for sector-shaped conductors 3/8" in 95-150 mm



Art. no.	set	drive	kg	PU
110873	14-pieces	3/8"	3,870	1

Reversible ratchet 1000 V

1/2"

full insulated, from shock-resistant plastic



Art. no.	drive	TL	kg	PU
220450	1/2"	250	0,550	1

Fittings for hexagon socket screws 1000 V

1/2"

1/2" square drive, made of chrome vanadium steel, forged, oil hardened, full insulated, from shock-resistant plastic



Art. no.	WS	drive	TL	kg	PU
220486	4	1/2"	120,0	0,113	1
220488	5	1/2"	120,0	0,113	1
220490	6	1/2"	120,0	0,113	1
220492	8	1/2"	120,0	0,115	1
220494	10	1/2"	120,0	0,134	1

Socket T-wrench 1000 V

1/2"

chrome vanadium steel, tempered, with locking device against accidental loosening of sockets or extensions, full insulated, from shock-resistant plastic



Art. no.	drive	TL	kg	PU
220452	1/2"	200	0,330	1

Extensions 1000 V

1/2"

with locking device against accidental loosening of sockets or extensions, full insulated, from shock-resistant plastic



Art. no.	drive	TL	kg	PU
220454	1/2"	125	0,208	1
220456	1/2"	250	0,411	1

Hexagon sockets 1000 V

1/2"

1/2" square drive, full insulated, from shock-resistant plastic



Art. no.	WS	drive	TL	kg	PU
220458	10	1/2"	55,0	0,055	1
220460	11	1/2"	55,0	0,055	1
220462	12	1/2"	55,0	0,058	1
220464	13	1/2"	55,0	0,058	1
220466	14	1/2"	55,0	0,061	1
220468	17	1/2"	55,0	0,069	1
220470	19	1/2"	57,0	0,072	1
220478	22	1/2"	57,0	0,087	1
220480	24	1/2"	57,0	0,095	1
220482	27	1/2"	57,0	0,125	1
220484	32	1/2"	57,0	0,170	1

Tool case 1000 V

1/2"

made of plastic, complete with 1/2" tools. The plastic material used for socket sets is guaranteed to pass -40°C impact tests. This guarantee that the insulation value will not be compromised due to impact. Dimension: 380 x 316 x 61 mm.

Contents:

- Reversible ratchet 250 mm, 1/2"
- T-slip-on-keys 200 mm, 1/2"
- Extension 125 and 250 mm, 1/2"
- Sockets 1/2", 10, 11, 12, 13, 14, 17, 19, 22, 24, 27, 32 mm
- Dies for hexagon screws 1/2", 4, 5, 6, 8, 10 mm



Art. no.	set	drive	kg	PU
220404	20-pieces	1/2"	4,000	1

SysCon „VDE-Socket“ 1/2"



complete with 1/2" tools. The plastic material used for socket sets is guaranteed to pass -40°C impact tests. This guarantee that the insulation value will not be compromised due to impact.

Contents:

1 220370 ABS plastic box „SysCon S"

- Reversible ratchet 250 mm, 1/2"
- T-slip-on-keys 200 mm, 1/2"
- Extension 125 and 250 mm, 1/2"
- Sockets 1/2", 10, 11, 12, 13, 14, 17, 19, 22, 24, 27, 32 mm
- Dies for hexagon screws 1/2", 4, 5, 6, 8, 10 mm



Art. no.	set	empty	drive	kg	PU
220612 *	20-pieces	220370	1/2"	7,200	1



Reversible ratchet 1000 V

1/2"

full insulated, 2-coloured coating-insulation - inside yellow/outside red



1000 V IEC 60900



Art. no.	drive	TL	kg	PU
110332/EN	1/2"	255	0,687	1

Locked torque wrench 1000 V

TQ 1/2"

reversible ratchet system, fixed factory-provided valve, possible valve between 5-27 Nm, valve must be indicate before delivery, full insulated, 2-coloured coating-insulation - inside yellow/outside red. **Torque must be specified when ordering!**

1000 V IEC 60900

TQ



Art. no.	drive	Nm	TL	kg	PU
300312/EN	1/2"	5-27	280	1,052	1

Torque wrenches 1000 V

TQ 1/2"

reversible ratchet system, fully insulated, 2-coloured coating-insulation - inside yellow/outside red

1000 V IEC 60900

TQ



Art. no.	drive	Nm	TL	kg	PU
110058/EN	1/2"	2-27	280	1,034	1
110066/EN	1/2"	5-50	370	1,121	1
110067/EN	1/2"	20-100	460	1,493	1
110068/EN	1/2"	60-220	530	1,300	1

Socket T-wrench 1000 V

1/2"

chrome vanadium steel, tempered, with locking device against accidental loosening of sockets or extensions, full insulated, 2-coloured coating-insulation - inside yellow/outside red

1000 V IEC 60900



Art. no.	WS	BL	handle	kg	PU
110040/EN	12,5	200	160	0,457	1

Extensions 1000 V

1/2"

with locking device against accidental loosening of sockets or extensions, full insulated, 2-coloured coating-insulation - inside yellow/outside red



1000 V IEC 60900



Art. no.	drive	TL	kg	PU
110336/EN	1/2"	125	0,197	1
110338/EN	1/2"	250	0,389	1

Extensions with bit adapter 1000 V

1/2"

full insulated, 2-coloured coating-insulation - inside yellow/outside red

1000 V IEC 60900



Art. no.	bit adapter	drive	TL	kg	PU
110862	1/4"	1/2"	250	0,165	1

Hexagon sockets 1000 V

1/2"

1/2" square drive, 4 edge drive, full insulated, 2-coloured coating-insulation - inside yellow/outside red

1000 V IEC 60900



Art. no.	WS	drive	TL	kg	PU
110339/EN	8	1/2"	50	0,080	1
110340/EN	10	1/2"	50	0,056	1
110342/EN	11	1/2"	50	0,062	1
110344/EN	12	1/2"	50	0,062	1
110346/EN	13	1/2"	50	0,066	1
110348/EN	14	1/2"	50	0,063	1
110350/EN	17	1/2"	50	0,076	1
110352/EN	19	1/2"	50	0,072	1
110354/EN	22	1/2"	50	0,104	1
110356/EN	24	1/2"	50	0,141	1
110358/EN	27	1/2"	50	0,191	1
110360/EN	30	1/2"	50	0,224	1
110362/EN	32	1/2"	50	0,268	1

Hexagon sockets DIN 7448, 1000 V, 80 mm

1/2"

extra long, 1/2" square drive, 4 edge drive, full insulated, 2-coloured coating-insulation - inside yellow/outside red

1000 V IEC 60900



Art. no.	WS	drive	TL	kg	PU
110373/EN	10	1/2"	80	0,085	1
110374/EN	11	1/2"	80	0,110	1
110375/EN	13	1/2"	80	0,123	1
110376/EN	14	1/2"	80	0,119	1
110377/EN	17	1/2"	80	0,157	1
110378/EN	19	1/2"	80	0,168	1
110379/EN	22	1/2"	80	0,230	1

Hexagon sockets, 1000 V, 125 mm

1/2"

extra long, 1/2" square drive, 4 edge drive, full insulated, 2-coloured coating-insulation - inside yellow/outside red

1000 V IEC 60900



Art. no.	WS	drive	TL	kg	PU
110346/125	13	1/2"	125	0,250	1
110348/125	14	1/2"	125	0,260	1
110350/125	17	1/2"	125	0,280	1
110352/125	19	1/2"	125	0,295	1
110354/125	22	1/2"	125	0,310	1
110356/125	24	1/2"	125	0,330	1
110358/125	27	1/2"	125	0,350	1
110360/125	30	1/2"	125	0,380	1
110362/125	32	1/2"	125	0,410	1

Hexagon sockets, 1000 V, 250 mm



extra long, 1/2" square drive, 4 edge drive, full insulated, 2-coloured coating-insulation - inside yellow/outside red



Art. no.	WS	drive	TL	kg	PU
110346/250	13	1/2"	250	0,485	1
110348/250	14	1/2"	250	0,500	1
110350/250	17	1/2"	250	0,530	1
110352/250	19	1/2"	250	0,550	1
110354/250	22	1/2"	250	0,580	1
110356/250	24	1/2"	250	0,605	1
110358/250	27	1/2"	250	0,635	1
110360/250	30	1/2"	250	0,660	1
110362/250	32	1/2"	250	0,670	1

Fittings for hexagon socket screws 1000 V



1/2" square drive, 4 edge drive, made of chrome vanadium steel, forged, oil hardened, full insulated, 2-coloured coating-insulation - inside yellow/outside red



Art. no.	WS	drive	TL	kg	PU
300294/EN	4	1/2"	70	0,094	1
300297/EN	5	1/2"	70	0,096	1
300295/EN	6	1/2"	70	0,101	1
300303/EN	8	1/2"	70	0,100	1
300306/EN	10	1/2"	70	0,106	1

Tool case 1000 V



made of plastic, complete with 1/2" tools. Dimension: 450 x 340 x 100 mm.

Contents:

- Reversible ratchet 1/2"
- Extension 125 mm, 1/2"
- Extension 250 mm, 1/2"
- Slip-on-keys 1/2"
- Hexagon sockets 1/2", 10, 12, 13, 14, 17, 19, 22, 24 mm
- Dies for hexagon screws 1/2", 5, 6, 8 mm
- 2C-VDE screwdriver 3,5 x 100 mm

with locking system



Art. no.	set	drive	kg	PU
220205/EN	16-pieces	1/2"	4,080	1

Tool case „Biber“ 1000 V



made of plastic, complete with 26 security tools. Dimension: 450 x 340 x 100 mm.

Contents:

- 2C-VDE electrician's screwdrivers 4 x 100, 5,5 x 125, 6,5 x 150, 8 x 175 mm
- VDE combination pliers 200 mm
- VDE side cutters 180 mm
- VDE telephone pliers, straight, 200 mm
- Reversible ratchet 1/2"
- Extension 250 mm, 1/2"
- Hexagon sockets 1/2", 10, 11, 12, 13, 14, 17, 19 mm
- Open end spanners 10, 11, 12, 13, 14, 17, 19 mm
- 2-pole voltage tester
- Cable knife
- Cable stripping knife

with locking system



Art. no.	set	drive	kg	PU
220146	26-pieces	1/2"	5,000	1

Alignment tool, 3/8" 1000 V

3/8" drive, for the alignment of 3 or 4-wire sector conductors, made from impact-resistant plastic



Art. no.	size	kg	PU
110704	95 - 150 mm ²	0,068	1
110705	185 - 240 mm ²	0,088	1

Universal alignment tool 1000 V

for aligning sector-shaped conductors from 50, 70, 95, 150, 185, and 240 mm²



1000 V IEC 60900



Art. no.	kg	PU
110709	0,142	1

Counter holder 1000 V

for the easier handling of screwed connections when assembling coupling sleeves, variably adjustable

1000 V IEC 60900



Art. no.	TL	mm	kg	PU
120101	240	0 - 15	0,280	1
120103	220	15 - 40	0,380	1
120104	300	25 - 50	0,610	1

Plastic wedges 1000 V

with bright slot for all common cable cutters, oval form without sharp edges

1000 V IEC 60900



Art. no.	material	TL	width	kg	PU
120102	plastic	22,5	4,5	0,234	1

Plastic wedges 1000 V

without slot, oval form without sharp edges, long version with large head

1000 V IEC 60900



Art. no.	material	TL	width	kg	PU
120100	plastic	20	2,5	0,085	1

Plastic wedges 1000 V

dimension: 16.3 x 3.7 mm



Art. no.	size	material	type	kg	PU
120094	1	plastic	without	0,051	1

Cleaning brushes Safety Line

PVC-pattern

1000 V IEC 60900



Art. no.	TL	width	kg	PU
150036	420	25	0,053	1
150037	420	28	0,061	1
150038	420	50	0,100	1

Electrician's safety levels

nonconducting plastic material, with 2 tubes horizontal and vertical



Art. no.	TL	kg	PU
240057	400	0,188	1
240058	600	0,274	1

PVC hammer 1000 V

Bounce-free, head of polyethylen, break-, wear- and splinter-proof, heads interchangeable

1000 V IEC 60900



Art. no.	TL	Ø	kg	PU
180295	290	25	0,570	1
180297	290	35	0,825	1

Combined dowel and contact spanners

may be used for screws 2 - 63 A by changing the insert, handle made from insulating material



Art. no.	TL	kg	PU
120002 *	105	0,046	1

Insulated tweezers VDE 1000 V

austenitic steel, pointed, PVC-insulated



1000 V IEC 60900



Art. no.	TL	form	kg	PU
211060	130	pointed	0,029	1



1000 V IEC 60900



Art. no.	TL	form	kg	PU
211064	145	wide round, flat,	0,042	1



1000 V IEC 60900



Art. no.	TL	form	kg	PU
211062	150	pointed round, bent,	0,031	1

1000 V Tool cases

Tool cases 1000 V can be found from page 359 on.



Voltage testers



Voltage tester "Profi LCDplus II"

The "Profi LCDplus II" is the new top model in our tried and tested professional series. The innovative two-pole voltage tester is characterised by a wide performance spectrum and practical one-handed operation. Thanks to the highest safety level CAT IV 1000 V, it is now also ideal for taking measurements on hybrid and electric vehicles, and also photovoltaic systems.

Functions and benefits

- Highest CAT IV 1000 V safety level
- Large, illuminated LCD
- Voltage display up to 1000 V AC and 1400 V DC
- Resistance measurement up to 1999 Ω
- Frequency display up to 1000 Hz

Technical data

Display:	Optical, LCD
Measuring range:	Automatic
Over-voltage category:	CAT IV 1,000 V
Dimensions:	300 x 75 x 20 mm
Weight:	270 g
Colour:	Red/black
Scope of delivery:	Including batteries
Accessories (optional):	Carry bag
Voltage range:	3-1000 V AC (TRMS/RMS) 4-1400 V DC
Throughput check:	0-200 Ω with acoustic signal
Phase display:	> 100 V AC
Voltage supply:	2 x 1.5 V AAA (display of voltages is possible even without batteries)
Polarity:	Yes (- in LCD)
PELV display:	Optical and vibrating
Protection class:	IP 65
Standard:	EN 61243-3:2010
Resistance measurement:	1-1999 Ω
Frequency measurement:	0-500 Hz
Data-hold:	Voltage and resistance
Automatic power off function:	Yes
FI/RCD test:	30 mA at 230 V AC using two buttons
Single-pole phase test:	Yes
Two-pole phase-sequence test:	Yes
Illumination of measuring point:	White LED
4-mm test tip adapter:	Can be unscrewed
Guarantee:	2 years

„Profi LCDplus II“

Display:	Optical, LCD
Measuring range:	Automatic
Over-voltage category:	CAT IV 1,000 V
Dimensions:	300 x 75 x 20 mm
Weight:	270 g
Colour:	Red/black
Scope of delivery:	Including batteries
Accessories (optional):	Carry bag
Voltage range:	3-1000 V AC (TRMS/RMS) 4-1400 V DC
Throughput check:	0-200 Ω with acoustic signal
Phase display:	> 100 V AC
Voltage supply:	2 x 1.5 V AAA (display of voltages is possible even without batteries)
Polarity:	Yes (- in LCD)
PELV display:	Optical and vibrating
Protection class:	IP 65
Standard:	EN 61243-3:2010
Resistance measurement:	1-1999 Ω
Frequency measurement:	0-500 Hz
Data-hold:	Voltage and resistance
Automatic power off function:	Yes
FI/RCD test:	30 mA at 230 V AC using two buttons
Single-pole phase test:	Yes
Two-pole phase-sequence test:	Yes
Illumination of measuring point:	White LED
4-mm test tip adapter:	Can be unscrewed
Guarantee:	2 years

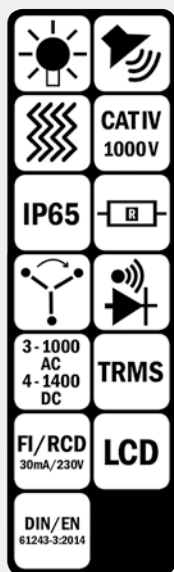

Art. no.	TMA	kg	PU
103826	3-1000	0,264	1

Voltage tester "Profi LEDplus II"

The new two-pole voltage tester "Profi LEDplus II" is the result of consistent further development of our popular "Profi LEDplus". It is characterised by user-friendly handling, robust and safe construction and meets all the requirements a specialist user makes of the modern voltage tester. Thanks to the highest safety level, CAT IV 1000 V, it is also suitable for measurements on hybrid and electrical vehicles as well as photovoltaic systems.

Functions and benefits

- Highest CAT IV 1000 V safety level
- Practical one-handed operation
- Robust, safe construction format
- Display on voltages even without battery

Technical data

Display:	Optical, LEDs
Measuring range:	Automatic
Over-voltage category:	CAT IV 1,000 V
Dimensions:	300 x 75 x 20 mm
Weight:	270 g
Colour:	Red/black
Scope of delivery:	Including batteries
Accessories (optional):	Carry bag
Voltage range:	6-1000 V AC
Throughput check:	0-50 kΩ optical/acoustic
Phase display:	> 100 V AC
Voltage supply:	2 x 1.5 V AAA (display of voltages is possible even without batteries)
Diode test:	Yes
Polarity:	Yes (+, - LED)
PELV display:	Optical and vibrating
Protection class:	IP 65
Standard:	EN 61243-3:2010
Automatic power off function:	Yes
FI/RCD test:	30 mA at 230 V AC using two buttons
Single-pole phase test:	Yes
Two-pole phase-sequence test:	Yes
Illumination of measuring point:	White LED
4-mm test tip adapter:	Can be unscrewed
Guarantee:	2 years

„Profi LEDplus II“

Display:	Optical, LEDs
Measuring range:	Automatic
Over-voltage category:	CAT IV 1,000 V
Dimensions:	300 x 75 x 20 mm
Weight:	270 g
Colour:	Red/black
Scope of delivery:	Including batteries
Accessories (optional):	Carry bag
Voltage range:	6-1000 V AC
Throughput check:	0-50 kΩ optical/acoustic
Phase display:	> 100 V AC
Voltage supply:	2 x 1.5 V AAA (display of voltages is possible even without batteries)
Diode test:	Yes
Polarity:	Yes (+, - LED)
PELV display:	Optical and vibrating
Protection class:	IP 65
Standard:	EN 61243-3:2010
Automatic power off function:	Yes
FI/RCD test:	30 mA at 230 V AC using two buttons
Single-pole phase test:	Yes
Two-pole phase-sequence test:	Yes
Illumination of measuring point:	White LED
4-mm test tip adapter:	Can be unscrewed
Guarantee:	2 years



Art. no.	TMA	kg	PU
103824	6-1000	0,280	1

Voltage tester "Basic +"

The two-pole voltage tester reliably indicates direct and alternating voltages within a range of 6 to 400 V in 7 intervals per LED (6, 12, 24, 50, 120, 230 and 400). The electronics also enable the determination of polarity and the phase to protective conductor. The "Basic +" is characterised by a user-friendly construction and robust housing that ensures long operational life. The rubberised handles offer non-slip hold. The "Basic +" operates without batteries. It takes its operating voltage from the test object.

Functions and benefits

- User-friendly and robust
- Voltage range up to 400 V AC/DC
- Phase search to protective conductor

Technical data

	„Basic +“
Display:	Optical, 8 LEDs
Over-voltage category:	CAT III 400 V
Dimensions:	120 x 60 x 30 mm
Weight:	100 g
Colour:	Red/black
Accessories (optional):	Carry bag
Voltage range:	6 - 400 V AC/DC
Voltage supply:	Via measuring object
Polarity:	Yes (+, - LED)
Standard:	EN 61243-3:2010
Housing:	High quality plastic with rubberised handle area
Guarantee:	2 years



Art. no.	TMA	TL	kg	PU
103800	6-400	120	0,097	1

"Multi Clamp II"

digital miniature clamp transducer AC/DC 600 V

Thanks to the versatile measuring functions, the digital probe ampere meter "Multi Clamp II" may be used universally. Handy details, such as the large display, the manual or automatic measuring range selection and the measuring point illumination, make operation particularly convenient and safe.

Functions and benefits

- Large range of functions
- Easy to read LCD
- LED measuring point illumination

Technical data

	„Multi Clamp II“
Display:	LCD with 4 digits
Over-voltage category:	CAT III 600 V
Dimensions:	220 x 75 x 35 mm
Weight:	340g
Colour:	Red/black
Scope of delivery:	Including measuring cables, batteries and carry bag
Voltage supply:	3x 1.5V
Diode test:	Test current - 1 mA, test voltage - 3.3 V
Throughput test:	Throughput tone under 30I@
Direct voltage:	600m, 6, 60, 600V
Direct current:	60A, 600A
Alternating voltage:	600mV, 6, 60, 600V, 40 to 400Hz
Alternating current:	60A, 600A, 40 to 400Hz
Alternating current accuracy:	±3.0 % +10 digit
Alternating current, highest resolution:	10 mA
Direct current, highest resolution:	10 mA
Alternating voltage accuracy:	±1.5 % +10 digit to 600 mV / ±1.2 % +5 digit to 60 V / ±1.5 % +10 digit to 600 V
Alternating voltage, highest resolution:	100 µV
Alternating voltage input resistance:	10 MΩ
Direct voltage accuracy:	±0.8 % +3 digit to 60 V / ±1.0 % +5 digit to 600 V
Direct voltage, highest resolution:	100 µV
Direct voltage input resistance:	10 MΩ
Frequency measuring tongs:	600 Hz, 1 kHz, > 1 A AC rms
Frequency measuring tongs, accuracy:	±1.5 % +5 digit to 1 kHz
Frequency measuring tongs, highest resolution:	100 mHz
Frequency measuring socket:	600 Hz, 6 kHz, 10 kHz, > 0.2 V AC rms
Frequency measuring socket, accuracy:	±1.5 % +5 digit to 10 kHz
Frequency measuring socket, highest resolution:	100 mHz
Sampling rate:	10 to 95 %, ±3.0 %, > 1 A AC rms
Sampling rate, frequency range:	10 Hz to 1 kHz
Sampling rate, capacity measurement:	To 60 mF
Resistance accuracy:	±1.2 % +2 digit to 6 MΩ ±2.0 % +5 digit to 60 MΩ
Resistance highest accuracy:	100 MΩ
Diode test resolution:	1 mV
Diode test throughput test:	Throughput tone under 30 Ω
Guarantee:	2 years

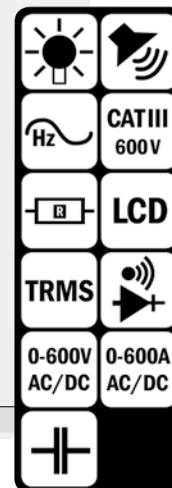

Art. no.	kg	PU
103809	0,426	1

haupa®

...convincing solutions



„Multi Check III” - digital high-capacity multimeter

The „Multi Check III” is particularly safe to use. Thanks to the automatic measuring range protection, it is impossible to operate incorrectly. In addition, the digital multimeter has an easy to read LC display with background illumination.

Functions and benefits

- Automatic measuring range protection
- Large LCD with background lighting
- Temperature measurement

Technical data

Display:	40 mm large, illuminated LCD
Over-voltage category:	CAT III 600 V
Weight:	410 g incl. batteries
Delivery scope:	incl. measuring cables, holster, temperature sensor and battery
Power supply:	2 x 1.5 V AA
Diode test:	Yes
Norm:	IEC/EN 61010-1, IEC/EN 61010-2-033
Dimensions:	183 x 95 x 50 mm
AC voltage:	600 mV, 6 V, 60 V, $\pm 0.8\%$, ± 3 digits
AC current:	600 V $\pm 0.8\%$, ± 3 digits 600 μ A, 6000 μ A, $\pm 1.5\%$, ± 3 digits 60 mA, 600 mA, $\pm 1.5\%$, ± 3 digits 10 A $\pm 3.0\%$, ± 10 digits
Operating temperature range:	0–40 °C (32–104 °F)
DC voltage:	600 mV, 6 V, 60 V, $\pm 0.7\%$, ± 2 digits 600 V $\pm 0.7\%$, ± 2 digits
DC current:	600 μ A, 6000 μ A $\pm 1.2\%$, ± 3 digits 60 mA, 600 mA, $\pm 1.2\%$, ± 3 digits 10 A $\pm 2.0\%$, ± 10 digits
Continuity test:	Yes
Input impedance:	> 7.5 M Ω , type 10 M Ω (ACV & DCV)
Frequency measuring range:	10 Hz–10 MHz
Capacity measuring range:	60 nF, 600 nF, 600 nF, $\pm 4.0\%$, ± 3 digits 6 μ F, 60 μ F, 600 μ F, $\pm 4.0\%$, ± 3 digits 6 mF, 60 mF, $\pm 4.0\%$, ± 3 digits
Storage temperature range:	-10–50 °C (14–122 °F)
Maximum input voltage:	600 V AC/DC
Fuses:	600 mA (self-resetting); 10 A/690 V (fast)
Temperature measurement:	-20–1000 °C with K-Type sensor
AC bandwidth:	50–400 Hz
Resistor:	600 Ω $\pm 1.2\%$, ± 5 digits 6 k Ω , 60 k Ω , 600 k Ω , 6 M Ω $\pm 1.2\%$, ± 5 digits 60 M Ω $\pm 2.0\%$, ± 10 digits
Guarantee:	2 years

„Multi Check III“

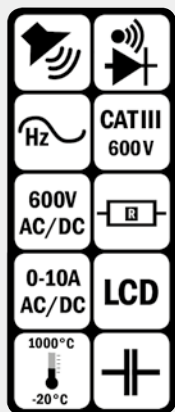

Art. no.	kg	PU
103815	0,410	1

Voltage tester „TestPen Profi”

The non-contact voltage tester „TestPen Profi” recognises current-carrying cables as of 12 V, including low-voltage systems. Invisible cable breaks in extension cords or a defect lamp in fairy lights can be localised to the centimetre in seconds thanks to the capacitive measuring procedure.

Functions and benefits

- Capacitive measuring procedure
- Measurements as of 12 V
- LED torch
- Vibrating display

Technical data

Display:	„TestPen Profi“ Optical and vibrating
Measuring range:	12–1000 V AC
Over-voltage category:	CAT III 1,000 V
Dimensions:	160 x 25 mm
Weight:	45 g
Colour:	Red
Scope of delivery:	Including batteries
Integrated LED torch:	Yes
Voltage supply:	2 x 1.5 V AAA Micro, LR03
Standard:	IEC/EN 61010-1 (DIN VDE 0411)
Housing:	Impact/break proof ABS plastic
Guarantee:	2 years



Art. no.	TMA	TL	kg	PU
103817	12-1000	140	0,190	1

Voltage testers VDE/GS

5 mm surrounding hand-protection, clip of insulating material, fixed installed scale with dark background



Art. no.	TMA	TL	BL	kg	PU
100700 *	125-250	190	-	0,036	1



Personal protection equipment



INFO

HUPsafetygloves - insulating gloves

Recommendation for use and maintenance

Insulating gloves are made of natural latex, which is very sensitive to light, heat and air.

- **Before each use:** Visually inspect the gloves and blow air into them to detect any air holes.
- **After use:** Clean and dry your gloves thoroughly.
- **Storage:** Keep the gloves away from heat, direct light and ozone.

In every case: The gloves must be visually inspected before every use for rips, cuts and holes!

ALWAYS:

- Determine the voltage with which you are working, to select the appropriate class (00 to 4).
- Wear insulating gloves that have been tested and approved.



Class	Alternating Current	Direct Current
00	500	750
0	1.000	1.500
1	7.500	11.250
2	17.000	25.500
3	26.500	39.700
4	36.000	54.000

Recommended maximum voltage according to IEC 60903

The nominal voltage corresponds to the phase-to-phase voltage in multi-phase circuits. The user can choose to use a different class of glove than the one recommended.

Typical direct current applications can be found in the rail and public transport sectors (the most dangerous situations are turning the power supply on and off).

HUPsafetyGloves in accordance with DIN EN 60903

Insulating natural rubber gloves, for working voltages of 500, 1.000, 7.500, 17.000 to 26.500 Volt. The ergonomic shape of the glove and its slightly powdered interior makes it easy the donning and doffing. The natural rubber provides dielectric properties.

Note: *The insulating gloves HUPsafetygloves must be stored in their original packaging in order to avoid damage to the product.*



DIN EN 60903

Art. no.	size	TL	strength	Class	kg	PU
120004	9	360	1,1	00	0,270	1
120005	10	360	1,1	00	0,293	1
120006 *	9	360	1,6	0	0,270	1
120007 *	10	360	1,6	0	0,280	1
120007/1	11	360	1,6	0	0,300	1
120006 561	10	360	2,1	1	0,646	1
120006 564 S	10	360	2,9	2	0,727	1
120006 587	10	360	3,5	3	0,947	1

HUPflashGloves - Insulating gloves that conform to DIN EN 60903, arc fault-tested

Three-in-one gloves that combine dielectric, mechanical and thermal (arc flash) resistance. Made of natural rubber with a special outer coating made of an orange-red high-performance elastomer, black inner coating and cutting edges, length 41 cm. For work voltages of 500, 1,000, 7,500, 17,000, 26,500 to 36,000 Volt. Category RC, with mechanical protection. Arc fault-tested: Box Text and ATPV. Specially profiled outer coating for a good grip even in wet or greasy conditions.

Norms: EN 60903 2003, IEC 60903 2014, PPE Category III (Reg EU 2016 425), IEC 61482-1-2 (arc fault protection), ASTM F 2675

USE: - Insulating composite gloves with integrated mechanical protection and arc fault protection.

Note: *The insulating HUPflashGloves need to be stored in the original packaging to prevent product damage.*



IEC 61482-1-2



DIN EN 60903



Art. no.	size	TL	strength	Class	kg	PU
121020/9	9	410	< 2,9	0	0,510	1
121020/10	10	410	< 2,9	0	0,520	1
121020/11	11	410	< 2,9	0	0,530	1
121021/10	10	410	< 3,4	1	0,670	1
121022/10	10	410	< 3,9	2	0,770	1
121023/10	10	410	< 4,2	3	0,800	1
121024/10	10	410	< 4,8	4	0,940	1



Personal protection equipment

Glove tester

Pneumatic tester for electrician's protective gloves. **It is recommended to carry out a test of this nature before starting work.**



Art. no.	kg	PU
120109	0,800	1

Cotton gloves for putting underneath

short cotton gloves to wear with latex-gloves
Art. No. 120004 - 120007



Art. no.	size	TL	kg	PU
120003	universal	275	0,041	1

Heat protection gloves acc. to EN 407

Inner glove for heat insulation according to EN 407, flame resistant, made from NOMEX III, heat insulation for contact and insulation against convective heat



Art. no.	size	TL	kg	PU
120011	universal	260	0,039	1

Outer gloves

for mechanical protection from insulated gloves for low voltages 2.5 kV and 5 kV. Made from cow-skin shagreen, water-repellent and silicone treated. Hoop and loop closure on the back of the hand. 150 mm length, sheath sewn on to the exterior. Leather thickness: Only 0.8 / 1.1 mm. Corresponds to the following standards: EN 420-94 General EEC criteria EN 388-94



Art. no.	size	TL	kg	PU	
120028	L	10	300	0,070	1

Set with protective gloves EN 60903

Safety set, 4 pieces in storage bag, with name plate window, made from polyester (art. no. 220259)

Contents: 120006, 120028, 120003

Note: The insulating gloves HUPsafetygloves (art. no. 120006) must be stored in their original packaging in order to avoid damage to the product.



Art. no.	TL	set	kg	PU
120029	400	4-pieces	6,860	1

Set with protective gloves EN 60903 light

Safety set, 3 pieces in storage bag, with name plate window, made from polyester (art. no. 220259)

Contents: 120006, 120003

Note: The insulating gloves HUPsafetygloves (art. no. 120006) must be stored in their original packaging in order to avoid damage to the product.



Art. no.	TL	set	kg	PU
120037	400	3-pieces	6,790	1

Safety fuse grips

with slip off protection and protection sleeve, for low voltage (NH) fuses class 00 - 3, protective sleeve made from smooth, impregnated leather



Art. no.	kg	PU
120012 *	0,563	1

haupa

...convincing solutions

Personal protection equipment

Leather working glove

Ideal for medium severity work in the construction, warehousing and transportation sectors, PSE in accordance with category 1 of the directive 89/686/EEC

- Split pigskin leather: Heat and cold resistant, high abrasion resistance, good skin protection
- Back of hand made from cotton
- Canvas cuff
- Single size 10.5



Art. no.	size	TL	kg	PU	
120310	L	10,5	250	0,343	1

PU textile glove

Ideal for fine mechanical tasks and low mechanical loads

- HPPE fibre
- Thin PU coating on palm and fingertips: Flexible and elastic, high abrasion resistance, safe grip
- Excellent fit, pleasant wearing comfort
- Area of use: Warehouse and assembly work, fine mechanical tasks

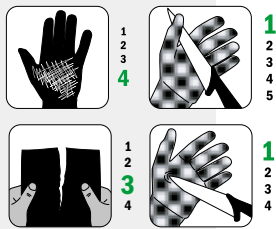

Art. no.	size	TL	kg	PU	
120300/6	XXS	6	250	0,027	12
120300/7	XS	7	250	0,027	12
120300/8	S	8	250	0,027	12
120300/9	M	9	250	0,027	12
120300/10	L	10	250	0,027	12
120300/11	XL	11	250	0,027	12

Our PU cut-protection gloves are used to protect against mechanical risks, in accordance with EN 388 and EN 420.

The „Hammer“ pictogram defines the performance level of the product.



Example:

- Abrasion resistance → 4
- Cut resistance → 5
- Tear propagation strength → 4
- Penetration resistance → 4

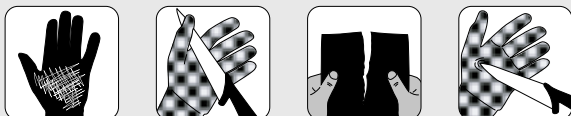

PU cut-protection glove, level 3

For high mechanical loads, good cut-protection due to cut-resistance level 3

- HPPE fibre
- PU coating on palm and fingertips: Flexible and elastic, high abrasion resistance, safe grip
- Excellent fit, pleasant wearing comfort
- Area of use: Warehousing and assembly work, fine mechanical tasks with slightly sharp objects

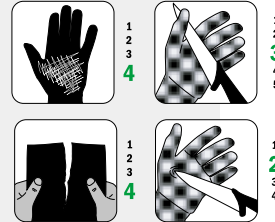

Art. no.	size	TL	kg	PU	
120302/9	M	9	260	0,049	1
120302/10	X	10	260	0,049	1
120302/11	XL	11	260	0,049	1

PU cut-protection glove, level 5

High cut-protection thanks to cut-resistance level 5, for high mechanical loads

- HPPE fibre
- Thick PU coating on palm and fingertips: Flexible and elastic, high abrasion resistance, safe grip
- Excellent fit, pleasant wearing comfort
- Area of use: Warehousing and assembly work, fine mechanical tasks with sharp objects

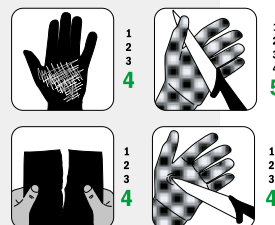

Art. no.	size	TL	kg	PU	
120304/9	M	9	260	0,069	1
120304/10	X	10	260	0,069	1
120304/11	XL	11	260	0,069	1

Personal protection equipment

Electricians' protection helmets acc. to DIN EN 50365 1000 V

low weight, very weatherproof even in cold areas and a stable and very comfortable 4-point belt strap interior. Usage period up to 5 years. Adjustable to head size, rain catch, slots for ear protection, mount for face protection shields (Art. 120010 + 120034)

⚡ 1000 V | Class 0

CE



Art. no.	colour	kg	PU
120008	green	0,343	1
120008 GELB	yellow	0,343	1
120008 ROT *	red	0,343	1
120008 WEISS	white	0,343	1

NEW

Electrician's helmet conforms to DIN EN 50365 1000 V, arc fault-tested

made of glass fibre reinforced polycarbonate, straight helmet shell with rain groove, extreme lateral stability, real leather sweatband and foam strips, **wearing period up to 10 years**, size can be adjusted from 51 - 64 cm, chin strap holder, attachment option for a face shield (Art. 120010 + 120034), MM-tested against metal splashes, meets the requirements of Category III of the EU Regulation 2016/425 Electrical Insulation (1,000 V symbol)

- Perfect protection against arc faults in conjunction with suitable face shield, tested acc. to RWE-Eurotest (10 kA/1 s)
- Cold test up to -30 °C, Heat test up to +150 °C,
- Certified to EN 50365 (0682 Part 321):2002-11

⚡ 1000 V | Class 0

CE



Art. no.	colour	kg	PU
120041	carmine red	0,370	1

Electricians protection visor acc. to EN 166

Protection against short circuit lighting, vision screen of acetate, glassy, transparent forehead protection, convenient head mounting and individual adjustable

CE ⚡ 1000 V



Art. no.	colour	kg	PU
150377	transparent	0,373	1

Electrician-safety face mask class II

Electrician-safety face mask with chin guard, protection according DIN EN 166 + 170, GS-ET-29 (protection against arc faults Class II, 7kA), luminous transmission index 0



Art. no.	colour	kg	PU
120034	transparent	0,275	1

Safety-face masks acc. to EN 166

for protection against arc faults

CE ⚡ 1000 V



Art. no.	colour	kg	PU
120010 *	transparent	0,275	1

Face shield EN 166

- Provides face protection against possible eye injuries and infections
- Perfectly suited for any kind of work
- Clear and wide vision, colourfast
- Impact resistant and crystal clear
- Light weight & more elastic, comfortable seat
- Universal size, can be adjusted to different head sizes
- Protection according to DIN EN 166

NEW

CE



Art. no.	colour	kg	PU
120106	transparent	0,275	1

haupa®

...convincing solutions

Personal protection equipment

Safety classes acc. to EN 166

Goggles with transparent lenses, black/orange nylon frame, lenses made of polycarbonate, light weight, high wearing comfort, protects against mechanical risks caused by flying parts, EN166, ANSI Z87.1

CE



Art. no.	kg	PU
120087 *	0,270	1

Safety classes acc. to EN 166

Single lens goggles with transparent lenses, black nylon frame, lenses made of polycarbonate, light weight, high wearing comfort, arm length can be adjusted. Protects against mechanical risks caused by flying parts, EN166, ANSI Z87.1

CE



Art. no.	kg	PU
120088 *	0,029	1

Ear defenders acc. to EN 352

Dielectric design for environments with the risk of electrical influences, supersoft sealing cushions for long comfort in wear, three wearing positions make combination with safety helmets, face and breathing masks and other safety equipment easy, SNR: 26 dB



Art. no.	dB	colour	kg	PU
120112	26	blue	0,184	1

Ear defenders acc. to EN 352

Enclosed hearing protectors according to EN 352 with universal bow, soft sealing cushions for long comfort in wear, SNR: 23 dB



Art. no.	dB	colour	kg	PU
120111	23	red	0,143	1

Ear muffs for helmet

Ear muffs including helmet holder, SNR 23 for all currently available protective helmets.



Art. no.	dB	colour	kg	PU
120116	23	green	0,184	1

Ear protection plugs

Universal size, the material adapts individually to every auditory canal, simple to handle, reusable SNR: 30 dB



Art. no.	dB	colour	kg	PU
120115	30	orange	0,010	1

Dust masks

light type, made of filter-fleece, against fine particulate matter



Art. no.	FFP	kg	PU
120120	filterclass P 1	0,010	1
120122	filterclass P 1	0,014	1

Electricians' boots acc. to EN 50321 Class 0

Available in the sizes 42 to 47



Art. no.	size	colour	kg	PU
120014	42	white	2,160	1
120015	43	white	2,235	1
120016	44 - 45	white	2,400	1
120017	46	white	2,550	1
120018	47	white	2,160	1

Security bag, empty

without contents, material: Nylon, extra long to hold the insulation stand mat



Art. no.		width	depth	height	kg	PU
300420	empty	390	50	590	0,680	1

Safety-sets VDE/GS

in practical bag, 6-pieces. **Contents:** Electricians' helmet, safety mask, safety handle, gloves size 10 (1000 V), insulating mat 1000 x 1000 x 4 mm



Art. no.	set	kg	PU
300228	* 6-pieces	6,860	1
300229	5-pieces (without insulating mat)	3,480	1

SysCon XL „SafetySet“



Content:

1 220650 ABS plastic box „SysCon XL“

1 120010 VDE electricians protection visor 1000 V

1 120007 VDE gloves 1000 V size 10

1 120008 Electricians' protection helmet

1 120012 VDE NH fuse grip



Art. no.	set	empty	kg	PU
220652	5-pieces	220650	2,000	1

Personal protection equipment

Climping irons acc. to DIN 48 345

postal-type, with 2 points, offset foot-plate and wide leather heel cap, width of points 260 mm, for wooden posts of 150 - 240 mm diam.



Art. no.		kg	PU
150280	wide counter	4,050	1

Safety belts acc. EN 358

safety belt universal for all sizes, length 1,50 meter, can bear loads of up to 100 kg



Art. no.	TL	kg	PU
150240	1,5 m	1,210	1

Fallstop acc. to EN 354

Breaking device and rope shortening acc. to EN 355, length 2 m, one hand spring hooks on both sides



Art. no.	TL	kg	PU
150274	2 m	1,090	1

Travelling safety device DIN 353-2, Type ASK 1

Rope shortener function: takes up slack rope and thus reduces height of the fall. **Fall absorber function:** in the case of a fall this limits the catching impact to a medically acceptable level of 6 kN. **Features:** Rope shortener made from V2A stainless steel, connection band with integrated fall absorber and self-securing trigger snap, high level of functional safety and absolutely maintenance free due to simplest mechanism, cannot be operated incorrectly, as every device is firmly attached to the rope



Art. no.	TL	strength	kg	PU
150275	5 m	12	1,953	1
150276	10 m	12	2,482	1
150277	15 m	12	3,062	1
150278	20 m	12	3,174	1
150279	25 m	12	3,675	1

Safety harness DIN EN 361

Universal harness, rapid adjustment of shoulder strap (orange, 45 mm), body strap (orange, 45 mm) and leg straps (blue, 45 mm), fits all sizes, 1 back D ring, 2 side rings, lightweight, comfortable fabric. The forces that develop during a fall are transferred to less sensitive parts of the body



Art. no.	kg	PU
150270	1,614	1

Personal safety set

Safety harness (150270), safety device (150277) and shock absorbing rope (15 m) in practical backpack



Art. no.	set	kg	PU
150258	4-pieces	4,961	1

Insulating floor mats acc. to IEC-61111

with anti-skid surfaces, colour: grey

art: 120030, 120031 = Class 2 / 17.000 Volt
art: 120033 = Class 4 / 36.000 Volt



Art. no.	KV	TL		kg	PU
120030 *	17	1000	1 m x 1 m x 3,0 mm	3,754	1
120031	17	10000	10 m x 1 m x 3,0 mm	role 34,000	1
120033	36	10000	10 m x 1 m x 4,5 mm	role 42,000	1

Isolating magnetic rubber towels

Isolating rubber towels 1000 V, with magnets, IEC 61112 A-KX 55-15 Class 0-Categorie A+Z.

120160: 300 x 500 x 1 mm with 6 magnets
120162: 500 x 700 x 1 mm with 12 magnets
120164: 300 x 700 x 1 mm with 8 magnets
120166: 1100 x 1100 x 1 mm with 20 magnets

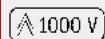

Video 120160_66



Art. no.	TL	width	strength	magnets	kg	PU
120160	300	500	1,0	6	0,370	1
120162	500	700	1,0	12	0,500	1
120164	300	700	1,0	8	0,700	1
120166	1100	1100	1,0	20	2,000	1

VDE magnet for rubber cloth

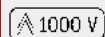

Art. no.	TL	width	strength	magnets	kg	PU
120168	70	70	1,0	1	0,025	1

Rubber towels acc. to VDE 0680/1

grease and acid-proof, for covering of live equipment



Art. no.	TL	width	strength	kg	PU
120040	120	120	1,6	0,037	1
120042	350	250	1,6	0,193	1
120044	600	600	1,6	1,000	1
120046 *	1000	1000	1,6	2,485	1
120048	1200	1200	1,6	3,200	1

Covering blankets transparent

in accordance with VDE 0680 part 1, with special labelling 1000 V, transparent, largely UV-resistant, flexible in the cold



Art. no.	TL	width	strength	kg	PU
120200	50000	1300	0,5	41,500	1
150322	25000	1200	1,0	38,000	1

Covering blankets transparent

in accordance with VDE 0680 part 1, with special labelling 1000 V, transparent, largely UV-resistant, flexible in the cold



Art. no.	TL	width	strength	kg	PU
150302	1000	600	1,0	0,750	1
150304	1000	600	0,5	0,332	1
150306	1000	400	1,0	0,520	1
150308	1000	400	0,5	0,260	1
150310	1000	300	1,0	0,380	1
150312	1000	300	0,5	0,190	1
150314	600	400	1,0	0,340	1
150316	600	400	0,5	0,171	1
150318	400	300	1,0	0,170	1
150320	400	300	0,5	0,100	1

Plastic clips 1000 V

for fastening of rubber towels



Art. no.	TL	opening	kg	PU
120049	80	25	0,029	1
120050 *	160	40	0,069	1

Self adhesive PVC tape

VDE 0340/T1/5.75, temperature area - 10 to + 90° C, 100 x 0,15 mm



Art. no.	TL	colour	kg	PU
120095	10000	grey	0,192	1
120096	10000	red	0,190	1

Slip on bushes 1000 V

for protective covering of bare live cable terminals, numbered: No. 1 - 2 - 3

⚠ 1000 V IEC 60900



Art. no.	TL	∅	for No.	kg	PU
120060 *	80	10	1	0,008	1
120062	80	10	2	0,008	1
120064	80	10	3	0,008	1

Slip on bushes 1000 V

self clamping, not numbered

⚠ 1000 V IEC 60900



Art. no.	TL	∅	kg	PU
120070	75	10	0,011	1
120072	100	20	0,121	1
120074	120	30	0,207	1
120071	135	40	0,372	1
120069	155	50	0,172	1
120073	150	60	0,144	1

Insulator cover for gable insulators 1000 V

with plastic buttons, absolutely safety attachments, touch protection on the bottom side, of weak, weather proofed insulation-material, for long term usage suitable

⚠ 1000 V IEC 60900



Art. no.	TL	width	kg	PU
120079	245	270	0,900	1

Insulator cover for gable insulators 1000 V

with plastic buttons, absolutely safety attachments, touch protection on the bottom side, of weak, weather proofed insulation-material, for long term usage suitable

⚠ 1000 V IEC 60900



Art. no.	TL	width	kg	PU
120089	115	270	1,100	1

Insulator cover for gable insulators 1000 V

double faced, inside soft and outside strong plastic, for transformers and similar products

⚠ 1000 V IEC 60900



Art. no.	TL	kg	PU
120057	80	0,400	1
120059	300	0,775	1

NH-protecting caps 1000 V

for the covering of spring contacts

⚠ 1000 V IEC 60900



Art. no.	TL	width	kg	PU
120058	315	170	0,390	1

NH-protecting caps 1000 V

for the covering of spring contacts

⚠ 1000 V IEC 60900



Art. no.	TL	width	kg	PU
120077	170	140	0,155	1
120078	255	135	0,205	1

Sealing pliers and accessories

Sealing pliers

made of cast iron, punch exchangeable and hardened, bright nickel-plated



Art. no.	TL	dies-Ø	kg	PU
210700 *	125	8	0,243	1
210702	145	9	0,316	1
210704	165	10	0,448	1

Dies for sealing pliers

loose dies



Art. no.	dies-Ø	kg	PU
210710	8	0,004	1
210712	9	0,004	1
210714	10	0,006	1

Engraving for sealing pliers

Special engraving on request

Art. no.	
210731	up to 3 letters
210732	every further letter
210733	every border

Lead seals



Art. no.	Ø	Quantity per kg	kg	PU
150340	8	850	1,080	1
150342	9	600	1,110	1
150344	10	400	1,010	1

Plastic seals



Art. no.	Ø	kg	PU
150343 *	9	0,002	1000
150345	10	0,003	1000

Seal wire

Material: Iron wire, galvanised



Art. no.	TL(m)	d1	d2	kg	PU
150360 *	115	0,5	0,5	0,532	1
150362	230	0,5	0,5	1,041	1
150364	190	0,5	0,3	0,530	1
150366	380	0,5	0,3	1,035	1
150368	300	0,3	0,3	0,533	1
150370	600	0,3	0,3	1,037	1

Plastic seal wire



Art. no.	TL(m)	d1	d2	colour	kg	PU
150375 BLAU	100	0,5	0,6	blue	0,199	1
150375 GRÜN	100	0,5	0,6	green	0,220	1
150375 ROT	100	0,5	0,6	red	0,207	1

haupa®

...convincing solutions

HAUPA GmbH & Co. KG, Koenigstr. 165-169, 42853 Remscheid, Phone: +49 (0)2191 8418-0, Fax: +49 (0)2191 8418-840, sales@haupa.com

Accessories

Parallel rope tension clamps

for copper and steel cables and wires



Art. no.	for ropes mm ²	∅	load kg	kg	PU
130064	6-35	3-8	1000	0,890	1
130066	16-70	4-12	1400	1,262	1
130068	50-100	8-16	2500	1,920	1

Hemp tackle block ropes

made of hemp, 20 m long



Art. no.	rope-∅	kg	PU
130042	8	0,950	1
130044	10	1,519	1

Tackle blocks

made from steel, with turnable hooks, 2 blocks, rust protected finish, with 3 brass rolls



Art. no.	roll-∅	rope-∅	load kg	kg	PU
130004	50	8	200	1,820	1
130006	60	10	250	1,700	1



Standard tools



INFO

Screwdrivers range

Industrial quality

The HAUPA screwdriver series features:

- homogenous size adjustment of the screwdriver handles for better power transmission. Enlargement of soft zone
- elegant, ergonomically shaped, non-slip 2-component handles made from PP/TPE material
- injected blade profile, for easy access in the tool case. Abrasion not possible!
- magnetic blade for secure hold of screws High-gripsystem
- blade made from molybdenum vanadium steel
- an addition anti-slip protection on Phillips profiles prevents the tool from slipping out of the screw

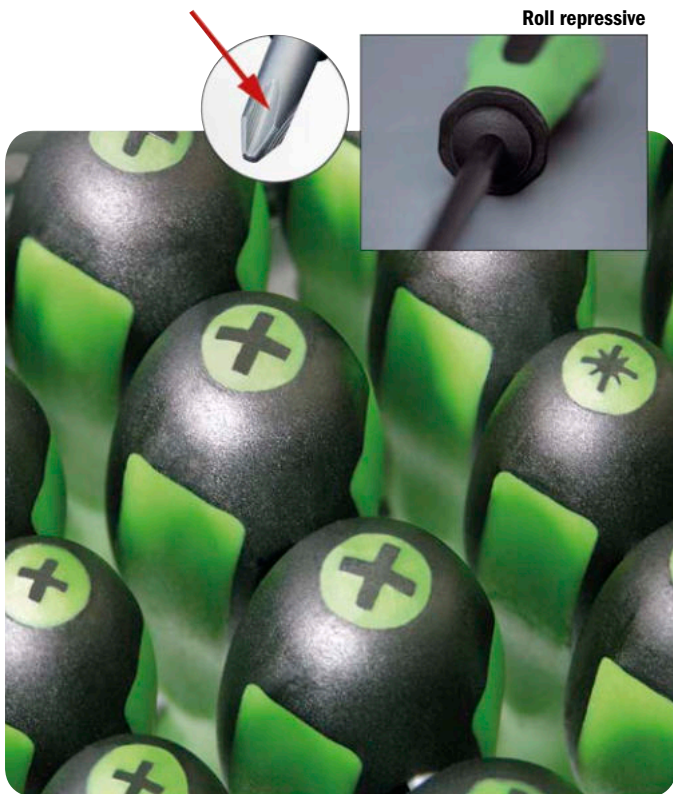

Screwdrivers

Electricians' screwdrivers Slot

with 2-component handle made from PP/TPE material, blade made from molybdenum-vanadium steel, sanded blade, hardened, chrome plated with black point



Art. no.	CW	KSt	BL	TL	kg	PU
101604 *	2,5	0,4	75	160	0,027	1
101606	4	0,8	100	195	0,051	1
101608	4	0,8	125	220	0,054	1
101610	5	1,0	150	245	0,067	1
101612	5	1,0	175	270	0,069	1
101614	5	1,0	200	295	0,074	1

Engineers' screwdrivers Slot

with 2-component handle made from PP/TPE material, blade made from molybdenum-vanadium steel, sanded blade, hardened, chrome plated



Art. no.	CW	KSt	BL	TL	kg	PU
101640	5	0,4	75	170	0,056	1
101642 *	6	1,2	100	205	0,090	1
101644	7	1,2	125	230	0,109	1
101646	8	1,2	150	270	0,160	1
101648	9	1,6	175	295	0,170	1
101650	10	1,6	200	320	0,238	1

Cross slotted screwdrivers Phillips

with 2-component handle made from PP/TPE material, blade made from molybdenum-vanadium steel, sanded blade, hardened, chrome plated, engraving on the blade ensures extra grip in the screw



Art. no.	size	BL	TL	form	kg	PU
101684	0	60	145	PH	0,032	1
101686	1	80	175	PH	0,055	1
101688 *	2	100	205	PH	0,087	1
101690	3	150	270	PH	0,161	1

Cross slotted screwdrivers Pozidriv

with 2-component handle made from PP/TPE material, blade made from molybdenum-vanadium steel, sanded blade, hardened, chrome plated



Art. no.	size	BL	TL	form	kg	PU
102612	1	80	175	PZ	0,055	1
102614 *	2	100	205	PZ	0,088	1
102616	3	150	270	PZ	0,160	1

Screwdrivers - blade PCV covered

Screwdrivers Tx

with 2-component handle made from PP/TPE material, blade made from molybdenum-vanadium steel, sanded blade, hardened, chrome plated with black point



Art. no.	size	BL	TL	form	kg	PU
101229/6	6	100	185	TX	0,036	1
101230	8	100	185	TX	0,036	1
101200	9	100	185	TX	0,036	1
101202	10	100	195	TX	0,057	1
101204	15	100	195	TX	0,054	1
101206	20	100	195	TX	0,058	1
101208	25	125	195	TX	0,064	1
101210	27	125	230	TX	0,093	1
101211	30	150	255	TX	0,093	1

Screwdrivers Square

with 2-component handle made from PP/TPE material, blade made from molybdenum-vanadium steel, sanded blade, hardened, chrome plated with black point



Art. no.	size	BL	TL	form	kg	PU
103130	0	60	145	SQ	0,032	1
103132	1	80	175	SQ	0,055	1
103134	2	100	205	SQ	0,087	1
103136	3	150	270	SQ	0,161	1

Screwdriver set Tx

screwdriver set Tx with security pin, with 2-component handle made from PP/TPE material, blade made from molybdenum-vanadium steel, sanded blade, hardened, chrome plated, 5-pieces.

Contents:

1 screwdriver each
Tx 10, Tx 15, Tx 20, Tx 25, Tx 30



Art. no.	form	set	kg	PU
101212/S *	TX	5-pieces	0,337	1

Electricians' screwdrivers Slot

with 2-component handle made from PP/TPE material, blade made from molybdenum-vanadium steel, sanded blade, hardened, blast-finished, blade black PVC covered



Art. no.	CW	KSt	BL	TL	kg	PU
101520 *	2,5	0,4	75	160	0,027	1
101521	3	0,5	100	195	0,030	1
101522	4	0,8	100	195	0,051	1
101524	4	0,8	125	220	0,054	1
101526	5	1,0	150	245	0,068	1
101528	5	1,0	175	270	0,072	1
101530	5	1,0	200	295	0,078	1

Engineers' screwdrivers Slot

with 2-component handle made from PP/TPE material, blade made from molybdenum-vanadium steel, sanded blade, hardened, blast-finished, blade black PVC covered



Art. no.	CW	KSt	BL	TL	kg	PU
101532	5	1,0	75	170	0,057	1
101534	6	1,2	100	205	0,091	1
101536	7	1,2	125	230	0,114	1
101538	8	1,2	150	270	0,146	1
101540	9	1,6	175	295	0,210	1
101541	10	1,6	200	320	0,214	1

Cross slotted screwdrivers Phillips

with 2-component handle made from PP/TPE material, blade made from molybdenum-vanadium steel, sanded blade, hardened, blast-finished, blade black PVC covered, engraving on the blade ensures extra grip in the screw



Art. no.	size	BL	TL	form	kg	PU
101542	0	60	145	PH	0,032	1
101544	1	80	175	PH	0,059	1
101546 *	2	100	205	PH	0,091	1
101548	3	150	270	PH	0,147	1

Cross slotted screwdrivers Pozidriv

with 2-component handle made from PP/TPE material, blade made from molybdenum-vanadium steel, sanded blade, hardened, blast-finished, blade black PVC covered



Art. no.	size	BL	TL	form	kg	PU
101550	1	80	175	PZ	0,056	1
101552 *	2	100	205	PZ	0,088	1
101554	3	150	270	PZ	0,146	1

haupa®

...convincing solutions

Screwdrivers - blade PCV covered

Screwdriver set



with 2-component handle made from PP/TPE material, blade made from molybdenum-vanadium steel, sanded blade, hardened, blast-finished, blade black PVC covered.

Contents:

2 electricians' screwdrivers
2 engineers' screwdrivers
2 screwdrivers Phillips



Art. no.	form	set	kg	PU
101560	Phillips	6-pieces	0,431	1

Screwdriver set



with 2-component handle made from PP/TPE material, blade made from molybdenum-vanadium steel, sanded blade, hardened, blast-finished, blade black PVC covered.

Contents:

2 electricians' screwdrivers
2 engineers' screwdrivers
2 screwdrivers Pozidriv



Art. no.	form	set	kg	PU
101562	Pozidriv	6-pieces	0,429	1

Screwdrivers

Stubby gasifier screwdrivers



with 2-component handle made from PP/TPE material, blade made from molybdenum-vanadium steel, sanded blade, hardened, blast-finished



Art. no.	CW	BL	TL	kg	PU
103120	6	30	80	0,050	1
103122	8	40	90	0,051	1

Stubby gasifier cross slot screwdrivers Phillips



with 2-component handle made from PP/TPE material, blade made from molybdenum-vanadium steel, sanded blade, hardened, blast-finished



Art. no.	size	BL	TL	form	kg	PU
103080	1	30	80	PH	0,051	1
103082	2	40	90	PH	0,051	1

Piercing awls

with 2-component handle made from PP/TPE material, blade made from molybdenum-vanadium steel, sanded blade, hardened, blast-finished



Art. no.	Ø	BL	form	kg	PU
103470	6	100	round	0,083	1
103472	6	100	square	0,085	1



Socket wrenches

Socket wrenches

with 2-component handle made from PP/TPE material, blade made from molybdenum-vanadium steel, sanded blade, hardened, blast-finished



Art. no.	WS	BL	TL	kg	PU
101484	5	125	220	0,105	1
101486	5,5	125	220	0,107	1
101488	6	125	220	0,110	1
101490	7	125	230	0,113	1
101492	8	125	230	0,115	1
101494	9	125	230	0,120	1
101496	10	125	230	0,124	1
103498	11	125	245	0,145	1
101500	12	125	245	0,165	1
101502	13	125	245	0,171	1

Socket wrenches set

with 2-component handle made from PP/TPE material, blade made from molybdenum-vanadium steel, sanded blade, hardened, blast-finished, 7-pieces.

Contents: 1 piece each
5 - 5,5 - 7 - 8 - 10 - 11 - 13 mm

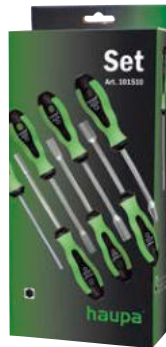

Art. no.	set	kg	PU
101510	7-pieces	0,898	1



HAUPA replaceable blade system

Industrial screwdriver set „Vario S2“ with replaceable dual blades.

NEW

2-component screwdriver shaft with 10 interchangeable blades, hexagonal, Material: bit steel S2, (chrome silicon manganese molybdenum vanadium steel), in robust nylon bag (with belt loop and hook and loop closure). To also use blades in the cordless screwdriver, as a long bit with a blade length of 175 mm. Loose interchangeable blades can be found on page 265.

Blade types:

Slotted 3, 4, 5, 7
Phillips 0, 1, 2, 3
Pozidriv 0, 1, 2, 3
Tx 10, 15, 20, 25
Hexagonal 2, 3, 4, 5



Art. no.	set	shank	kg	PU
104008-1	11-pieces	hexagonal	1,060	1

haupa[®]

...convincing solutions

INFO

Dynamometric screwdriver with replaceable blades

The new HAUPA 1000 V VarioTQ dynamometric screwdriver is characterised by its precision and functionality.

The ergonomic handles can be adjusted individually.

1. 1.0 - 6.0 Nm
2. 0.5 - 3.5 Nm

HAUPA offers all relevant blade tip profiles as individual items and in set form in a high-quality nylon case.

„VarioTQ“ dynamometric screwdriver with replaceable blades

VarioTQ

NEW

replaceable dual blades made from molybdenumvanadium steel, sanded blade, hardened, blast-finished, chrome plated with black point, with hexagonal shaft, in robust nylon bag (with belt loop and hook and loop closure), 10 replaceable blades (**20 profiles**)

Contents:

- 2-component exchangeable handle 1 - 6 Nm or 0,5 - 3,5 Nm
- slotted 3/4 - 5,5/6,5
- PH0/PH1
- PZ0/PZ1
- PH2/PZ2
- TX 10/15 - 20/25
- HEX 2/3 - 4/5
- PZ/FL1
- PZ/FL2
- Square socket key



Art. no.	form	Nm	set	kg	PU
103000-1	Mix	1 - 6	12-pieces	0,765	1
103002-1	Mix	0,5 - 3,5	12-pieces	0,765	1

Art. no.	nylon bag	width	height	depth	kg	PU
103034-1	empty	250	135	30	0,130	1

VarioTQ

- torque can be set using a separate key
- scale value can easily be read off
- clearly perceptible and audible signal when the set torque is achieved
- torque accuracy according to EN ISO 6789:2013-10

Replaceable dual blades

made from molybdenum-vanadium steel, sanded blade, hardened, blast-finished, chrome plated with black point

Precisely adjustable torque

Two handle versions, also available individually:

Art. no. 103070
1.0 - 6.0 Nm

Art. no. 103072
0.5 - 3.5 Nm



HAUPA replaceable blade system „VarioTQ“

Replaceable blade

insulated replaceable blade made from molybdenum vanadium steel, hardened, blasted, individually tested, for art. 103000-1, 103002-1, 104008-1, 103070 and 103072. Can also be used in cordless screwdrivers.



Replaceable blade - pozidrive blade/slotted

Art. no.	form	size	BL	kg	PU
103028	PZ/FL	1 + 2	175	0,040	1



Replaceable blade - slotted blade

Art. no.	form	CW	BL	kg	PU
103010	SL	3 + 4	175	0,040	1
103012	SL	5,5 + 6,5	175	0,040	1



Replaceable blade - Phillips blade

Art. no.	form	size	BL	kg	PU
103014	PH	0 + 1	175	0,040	1



Replaceable blade - pozidrive blade

Art. no.	form	size	BL	kg	PU
103016	PZ	0 + 1	175	0,040	1



Replaceable blade - Phillips blade/pozidrive blade

Art. no.	form	size	BL	kg	PU
103018	PH + PZ	2 + 2	175	0,040	1



Replaceable blade - torx blade

Art. no.	form	size	BL	kg	PU
103020	TX	10 + 15	175	0,040	1
103022	TX	20 + 25	175	0,040	1



Replaceable blade - hex blade

Art. no.	form	size	BL	kg	PU
103024	HEX	2 + 3	175	0,040	1
103026	HEX	4 + 5	175	0,040	1



Replaceable blade - Square

Art. no.	form	size	BL	kg	PU
103030	SQ	0 + 2	175	0,185	1
103032	SQ	1 + 3	175	0,185	1

Exchangeable „VarioTQ“ handle

TQ

automatic locking mechanism ensures that blades do not fall out unexpectedly, ergonomically formed 2 component book of PP/TPE material, precisely adjustable torque



TQ

Art. no.	TL	Nm	kg	PU
103070	125	1 - 6	0,185	1
103072	125	0,5 - 3,5	0,185	1

Square socket key

for adjustment of the torque for VarioTQ replacement blades



Art. no.	form	BL	BL	kg	PU
102784	SQ	40	8	0,056	1

Replacement blades suitable for the "VarioTQ" and "Vario S2" systems

haupa®

...convincing solutions

Electronic screwdrivers

INFO

ESD electronic screwdrivers

Now with 2-component handle, these screwdrivers do not just convince because of their homogenous design, but also because of their user-friendly handle.

Benefits:

- chrome molybdenum vanadium steel
- blades hardened throughout
- two component handles, hard and soft components
- permanently discharging special synthetic material
- Quick rotating zone
- rotating centring head with recessed grip
- black precision tips
- chromed blade



Security advice:

HAUPA ESD screwdrivers are not insulating and therefore unsuitable for work with live parts.

ESD electronic screwdrivers

Blade made from chrome molybdenum vanadium steel, chromed with black tip, slotted



Art. no.	CW	BL	TL	kg	PU
100704	0,8	60	150	0,023	1
100250	1,0	50	150	0,014	1
100704 A	1,2	60	150	0,021	1
100241	2,5	60	150	0,015	1
100243	3,5	100	150	0,018	1
100252	1,6	50	150	0,014	1
100257	2,0	50	150	0,015	1
100259	2,4	75	175	0,017	1
100261	3,0	100	200	0,020	1

ESD electronic screwdrivers

Blade made from chrome molybdenum vanadium steel, chromed with black tip, cross recess, Philipps

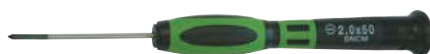

Art. no.	size	BL	TL	form	kg	PU
100714	000	50	150	PH	0,015	1
100715	00	50	150	PH	0,022	1
100716	0	50	150	PH	0,024	1
100249	1	50	150	PH	0,017	1

ESD electronic screwdrivers

Blade made from chrome molybdenum vanadium steel, chromed with black tip, hexagonal



Art. no.	size	BL	TL	form	kg	PU
100728	1,5	50	150	HEX	0,014	1
100729	2,0	50	150	HEX	0,015	1
100729 A	2,5	50	150	HEX	0,017	1
100736	3,0	50	150	HEX	0,020	1

ESD electronic screwdrivers

Blade made from chrome molybdenum vanadium steel, chromed with black tip, Tx/Safety Tx



Art. no.	size	BL	TL	form	kg	PU
100741	4	50	150	TX	0,017	1
100742	5	50	150	TX	0,018	1
100718 A	6	50	150	TX	0,018	1
100720	7	50	150	S-TX	0,014	1
100721	8	50	150	S-TX	0,018	1
100712	9	50	150	S-TX	0,018	1
100713	10	50	150	S-TX	0,016	1
100723	15	50	150	S-TX	0,020	1
100734	20	50	150	S-TX	0,020	1

ESD electronic screwdrivers

Blade made from chrome molybdenum vanadium steel, chromed with black tip, Tri-Wing



Art. no.	size	BL	TL	kg	PU
100738	2,4	50	150	0,017	1

ESD electronic screwdriver set

Blade made from chrome molybdenum with 2-component handles, 7-pieces, slotted/cross recess.

Contents:

1 ESD electronic screwdriver each 1.6 x 50, 2.0 x 50, 2.4 x 50, 3.0 x 50 and 1 Phillips size 1.0 and 00 x 50 each



Art. no.	set	kg	PU
104010	7-pieces	0,225	1

Precision screwdrivers

HAUPA Electronic screwdriver set standard



chrome vanadium steel, chrome-plated, with large plastic handle, with black point, 7 pieces.

Contents:

1 Electricians' screwdriver size 1.6 x 50, 2.0 x 50, 2.4 x 50, 3.0 x 50, and 1 Phillips size 1, 0 and 00 x 50



Art. no.	set	kg	PU
104000 *	7-pieces	0,221	1

Electronic screwdriver set

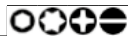

Chrome vanadium steel, screw holder with black /green plastic handle, 4 x hex head 3, 4, 5, 6 and 8 exchangeable screwdriver blades (slot/Phillips/Tx/hex head)



Art. no.	set	kg	PU
104004	13-pieces	0,288	1

Electronic screwing bit set



Chrome vanadium steel, screw holder with black/green plastic handle, 1 bit holder, 2 nuts of 5 + 6 mm, 30 bits for slot/Phillips/Pozidriv/Tx/hex head

Contents:

4 Bits PH 000, 00, 0, 1
 2 Bits PZ 0, 1
 7 Bits Schlitz 1, 1.5, 2, 2.5, 3, 3.5, 4
 8 Bits Hex 0.7, 0.9, 1.3, 1.5, 2, 2.5, 3, 4
 9 Bits Tx 4, 5, 6, 7, 8, 9, 10, 15, 20



Art. no.	set	kg	PU
104002 *	34-pieces	0,230	1

Claw retrievers

with inflexible shaft, chrome-plated, for gripping and retrieving of small parts in normally inaccessible places



Art. no.	TL	kg	PU
100366	525	0,050	1

Checking mirrors

with double ball joint



Art. no.	TL	Ø	kg	PU
100680	210	60	0,028	1

Magnetic retriever

flexible shaft and plastic handle



Art. no.	TL	Ø	kg	PU
100694	520	12	0,097	1

haupa[®]

...convincing solutions

Allen keys

Allen keys set

chrome vanadium steel, (59 Cr-Mo-V 4), DIN 911, chrome plated, on key ring.

Contents:

size 2,5 - 3 - 4 - 5 - 6 - 8 - 10



Art. no.	size	quantity	kg	PU
100640 *	2,5-10	8	0,250	1

Allen keys set

chrome vanadium steel, (59 Cr-Mo-V 4), im metal clip, key bronzed, DIN 911.

Contents:

Art. 100630: 2,5-3-4-5-6-8 mm
 Art. 100633: 1,5-2,5-3-4-5-6 mm
 Art. 100634: 2,5-3-4-5-6-8-10 mm



Art. no.	size	quantity	kg	PU
100630	2,8-8	6	0,249	1
100633	1,5-6"	7	0,145	1
100634	2,5-10"	7	0,335	1

Allen keys set

chrome vanadium steel, (59 Cr-Mo-V 4), im metal clip, key bronzed, DIN 911.

Contents:

Art. 100632: 3/32-1/8-5/32-3/16-1/4-5/16" AF
 Art. 100635: 1/16-5/64-3/32-1/8-5/32-3/16-7/32" AF
 Art. 100636: 3/32-1/8-5/32-3/16-1/4-5/16-3/8" AF



Art. no.	size	quantity	kg	PU
100632	3/32"-5/16"	6	0,251	1
100635	1/16"-7/32"	7	0,135	1
100636	3/32"-3/8"	7	0,328	1

Key set Tx

chrome vanadium steel, (59 Cr-Mo-V 4), in metal-clip, surface black, keys black.

Contents:

TX 9 - 10 - 15 - 20 - 25 - 27 - 30 - 40



Art. no.	size	quantity	kg	PU
100943	TX9 - 40	8	0,260	1

Ball point allen keys

chrome vanadium steel, (59 Cr-Mo-V 4), im metal clip, black keys, DIN 911

Contents:

size 2.5 - 3 - 4 - 5 - 6 - 8 - 10



Art. no.	size	quantity	kg	PU
100917	2,5-10	7	0,334	1

Allen keys set

chrome vanadium steel, (59 Cr-Mo-V 4), chrome plated, DIN 911, 8 pieces in handy plastic box, with sliding plexiglasscover.

Contents:

size 2 - 2.5 - 3 - 4 - 5 - 6 - 8 - 10



Art. no.	size	quantity	kg	PU
100585	2-10	8	0,303	1

Ball point allen keys

chrome vanadium steel, (59 Cr-Mo-V 4), DIN 911, chrome-plated, 8 pieces in handy plastic box, with pushable plexiglasscover.

Contents:

size 2 - 2.5 - 3 - 4 - 5 - 6 - 8 - 10



Art. no.	size	quantity	kg	PU
100915	2-10	8	0,301	1

Allen keys set Tx

chrome vanadium steel, (59 Cr-Mo-V 4), 8 pieces in handy plastic box, surface black.

Contents:

TX 9 - 10 - 15 - 20 - 25 - 27 - 30 - 40



Art. no.	size	quantity	kg	PU
100941	TX9 - 40	8	0,205	1

Hexagon screwdriver set T-handle, with spherical head

Made from chrome vanadium steel, completely hardened, chrome plated with 2-component handle, hexagonal with spherical head.

Contents:

WS: Hex 2, 2.5, 3, 4, 5, 6, 8, 10



Art. no.	size	quantity	kg	PU
100961	2-10	8	0,400	1

Hexagon angle screwdriver set, with spherical head

Made from chrome vanadium steel, completely hardened, nickel plated, **extra long**, metric, with spherical head, in folding holder.

Contents:

WS: Hex 1.5, 2, 2.5, 3, 4, 5, 6, 8, 10



Art. no.	size	quantity	kg	PU
100921 *	1,5-10	9	0,300	1

Hexagon angle screwdriver set, with spherical head

Made from chrome vanadium steel, blades hardened throughout, nickel plated, **extra long**, metric or AF, with spherical head, in folding holder.

Content metric:

WS: Hex 1.5, 2, 2.5, 3, 4, 5, 6, 8, 10

Content AF:

WS: Hex 1/16 - 5/64 - 3/32 - 1/8 - 5/32 - 3/16 - 1/4 - 5/16 - 3/8"



Art. no.	size	quantity	kg	PU
100965 *	1,5-10	9	0,420	1
100967	1/16"-3/8"	9	0,420	1

Hexagon angle screwdriver set, with spherical head

Made from chrome vanadium steel, blades hardened throughout, nickel plated, metric or AF, with spherical head, in folding holder.

Content metric:

WS: Hex 1.5, 2, 2.5, 3, 4, 5, 6, 8, 10



Art. no.	size	quantity	kg	PU
100927	1,5-10	9	0,420	1

Allen keys DIN 911

chrome vanadium steel, (59 Cr-Mo-V 4), DIN 911, chrome plated



Art. no.	TL	WS	Inch	kg	PU
100590	45x14	1,5	1/16"	0,020	1
100592	50x16	2	5/64"	0,020	1
100594	56x18	2,5	3/32"	0,020	1
100596	63x20	3	1/8"	0,030	1
100598	70x25	4	5/32"	0,080	1
100600	80x28	5	3/16"	0,019	1
100602	90x32	6	1/4"	0,028	1
100606	100x36	8	5/16"	0,058	1
100610	112x40	10	3/8"	0,099	1
100612	125x45	12		0,160	1
100614	132x50	13	1/2"	0,202	1

Ball point allen keys

chrome vanadium steel, (59 Cr-Mo-V 4), DIN 911, chrome plated



Art. no.	TL	WS	Inch	kg	PU
100902	56x18	2,5	3/32"	0,003	1
100903	63x20	3	1/8"	0,005	1
100904	70x25	4	5/32"	0,011	1
100905	80x28	5	3/16"	0,019	1
100906	90x32	6	1/4"	0,029	1
100908	100x36	8	5/16"	0,058	1
100909	112x40	10	3/8"	0,102	1

Voltage testers

Voltage tester 120-250 V

with clear-transparent, shock-resistant plastic handle.

Art. No. 100646, 100648 each in wallet

Art. No. 100647, 100649 loose



Art. no.	BL	TL	TMA	kg	PU
100646	50x3	140	120-250	0,020	1
100647 *	50x3	140	120-250	0,016	1
100648	100x3,5	190	120-250	0,037	1
100649	100x3,5	190	120-250	0,032	1

Voltage tester

Finnish type, Cellidor, only available for Finland



Art. no.	BL	TL	TMA	kg	PU
100645	50x3	140	150-250	0,016	1

Voltage testers VDE/GS

5 mm surrounding hand-protection, clip of insulating material, fixed installed scale with dark background



Art. no.	BL	TL	TMA	kg	PU
100700 *	-	190	125-250	0,036	1



INFO

Bits

Industrial quality

HAUPA-Bits are made of high-alloyed tool steel, best hardened (H Rc 60 - 63). They show very high tenacity and tolerance. The long life speaks of the hard use and quality.



1 box = 10 pieces (self-service packaging)

Screwdriver bits

DIN 3126, form E 6,3, shank 1/4", 10 pieces in box



Art. no.	size	CW	TL	kg	PU
102110	0,6x4,5	4,5	50	0,104	1
102112	0,8x5,5	5,5	50	0,115	1

Screwdriver bits

DIN 3126, form E 6,3, shank 1/4", 10 pieces in box



Art. no.	size	TL	kg	PU
102152	PH 1	25	0,062	1
102154	PH 2	25	0,067	1
102114	PH 1	50	0,105	1
102116	PH 2	50	0,124	1
102166	PH 2	90	0,097	1
102172	PH 1	150	0,251	1
102174	PH 2	150	0,358	1

Screwdriver bits, reduced

DIN 3126, form E 6,3, shank 1/4", 10 pieces in box
for PH 1 and PH 2



Art. no.	size	TL	kg	PU
102155	2	25	0,064	1

Bits

Screwdriver bits



DIN 3126, form E 6.3, shank 1/4", 10 pieces in box



Art. no.	size	TL	kg	PU
102176	PZ 1	25	0,062	1
102178 *	PZ 2	25	0,065	1
102118	PZ 1	50	0,107	1
102120	PZ 2	50	0,123	1
102188	PZ 1	90	0,179	1
102190	PZ 2	90	0,231	1
102198	PZ 2	150	0,360	1

Screwdriver bits Tx



DIN 3126, form E 6.3, shank 1/4", 10 pieces in box



Art. no.	size	TL	kg	PU
102200	Tx 15	25	0,061	1
102204	Tx 25	25	0,065	1
102124	Tx 20	50	0,110	1
102126	Tx 25	50	0,112	1

Bits for PZ slot profile



The PZ/FL profile can only be used for combination screws that were previously screwed with a slot or recessed head PZ type screwdriver. The screws have an inner PZ profile with an additional cross slot that also allows it to be screwed with a slot screwdriver

1 PU (packaging unit) = 2 pieces



Art. no.	size	TL	kg	PU
101874	1	60	0,012	1
101876	2	60	0,013	1
101880	1	90	0,179	1
101882	2	90	0,231	1

Magnetic holder

with strong magnetic, shank 1/4", form C 6,3 DIN 3126, for holding the screws, socket made of stainless steel, suitable for all



Art. no.	TL	kg	PU
102130	75	0,056	1

SDS magnetic holder

with strong permanent magnet, bit holder 1/4", form C 6.3 DIN 3126, to hold screws, rust-free, stainless steel sleeve, suitable for SDS bits holders



Art. no.	TL	kg	PU
102131	55	0,045	1

Magnetic holder

with strong magnetic, shank 1/4", form C 6.3 DIN 3126, for holding the screws, socket made of stainless steel, with inside ring, suitable for all



Art. no.	TL	kg	PU
102132	75	0,045	1
102134	60	0,040	1

Ratchet screwdriver, bits

„BitBox“, 25 mm, 17-pieces

BitBox

Description:

- Belt clip
- Ergonomic (with the opening of the box the bits will be moved in 45° angle, easy pick up position)
- A special mechanism fixes the bits even in an up side down position

Contents:

Screwdriver bits, form E 6.3, shank 1/4", 25 mm
 PH: 1, PH 2, PH 3
 PZ: 1, PZ 2, PZ3
 Tx: 10, T 15, T 20, T 25
 slotted: 4.0 (0.5), 5.0 (0.8), 5.0 (1.0), 6.0 (1.0)
 hexagon: 4.0, 5.0, 6.0
 Magnetic holder 60 mm



Art. no.	Bit	set	kg	PU
102210 *	= 25 mm	17-pieces	0,170	1

HAUPA „BitBox+“

BitBox+

Sturdy black plastic polypropylene, the constant hinge gives maximum stability. Safety and special bit set - top quality S2!

1/4" = 25 mm Bits

Contents:

1/4" 25 mm Power bits PH: 2x 0, 2x 1, 4x 2, 2x 3
 1/4" 25 mm Power bits PZ: 2x 0, 2x 1, 4x 2, 2x 3
 1/4" 25 mm Power bits TX: T10, T15, T20, T25
 1/4" 25 mm Power bits HEX: H3, H4, H5, H6
 1/4" 25 mm Power bits R: 1, 2, 3



Video 102212



Art. no.	bit	set	kg	PU
102212	= 25 mm	32-pieces	0,400	1

„BitBox S“, 50 mm, 7-pieces

BitBox

50 mm 1/4" bits in plastic box

Contents:

1 bit PH 1, 2
 1 bit PZ 1, 2
 1 bit PZ/FL 1, 2
 1 bit Slot 4



360° | 102216



Art. no.	Bit	set	kg	PU
102216	50 mm	7-pieces	0,105	1

Ratchet screwdriver, bits

Ratchet screwdriver set „Flex“

Flex

Ratchet screwdriver with right/left hand motion. Adjustable operating angle of 180°. Safety and special bit set - top quality S2! The screw handle with a quick change bit system and 2-component handle ensure non-slip and fatigue-free work. The ergonomic form and the soft zones within the pressure area range make a relaxed possible screws. With hanging up hole.

Only for 1/4", = 25 mm Bits.

Advantages:

- Ratchet function
- Left/clockwise rotation adjustable
- Bending bar: 0° - 45° - 90°
- Ergonomic working within restrained ranges
- S2 steel industry bit for nearly all applications
- 2-components handle
- 55 bits 1/4" 25 mm and 1 adapter for 1/4" nut

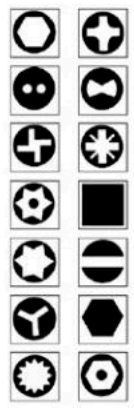

Art. no.	bit	set	kg	PU
104006 *	= 25 mm	58-pieces	0,810	1

Ratchet screwdriver set „FlexBox“

FlexBox

Sturdy black plastic polypropylene, the constant hinge gives maximum stability. Ratchet screwdriver with right/left hand motion. Adjustable operating angle of 180°. Safety and special bit set - top quality S2! The screw handle with a quick change bit system and 2-component handle ensure non-slip and fatigue-free work. The ergonomic shape and the soft zones guarantee relaxed screwing.

Only for 1/4" = 50 mm Bits.

Contents:

- 1/4" 50 mm Power bits SL: 4, 6
- 1/4" 50 mm Power bits PZ: 1, 2
- 1/4" 50 mm Power bits PZ/FL 1 + 2
- 1/4" 50 mm Power bits Hex: H5, H6
- 1 pc of „FlexPlus“ ratcheting driver

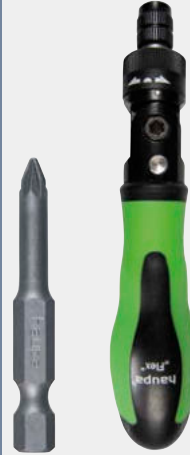

Art. no.	bit	set	kg	PU
104030	= 50 mm	9-pieces	0,350	1

haupa®

...convincing solutions

Ratchet screwdriver, bits

Ratchet screwdriver „FlexPlus“, for all bits

FlexPlus

Ratchet screwdriver with right/left hand motion. Adjustable operating angle of 180°. Safety and special bit set - top quality S2! The screw handle with a quick change bit system and 2-component handle ensure non-slip and fatigue-free work. The ergonomic form and the soft zones within the pressure area range make a relaxed possible screws.



Art. no.	bit	kg	PU
104009	≥ 25 mm, 50 - 150 mm	0,216	1



Ratchet screwdriver set „FlexBag“ with 50 mm S2 bits and reduced shank, in robust nylon bag.

FlexBag

Ratchet screwdriver with right/left hand motion. Adjustable operating angle of 180°. Safety and special bit set - top quality S2! The screw handle with a quick change bit system and 2-component handle ensure non-slip and fatigue-free work. The ergonomic form and the soft zones within the pressure area range make a relaxed possible screws.

Contents:

- 1/4" 50 mm Power bits Tx: T5, T6, T7, T8, T9, T10, T15, T20, T25, T30, T40
- 1/4" 50 mm Power bits Hex (hole): H2, H2.5, H3, H4, H5, H6
- 1/4" 50 mm Power bits PH: 0, 1, 2, 3
- 1/4" 50 mm Power bits PZ: 0, 1, 2, 3
- 1/4" 50 mm Power bits slot: 3, 4, 5, 6, 7, 8
- 1/4" 50 mm Power bits SQ: 0, 1, 2, 3
- 1/4" 50 mm Power bits Tri-Wing: 1, 2, 3
- 1/4" 50 mm Power bits PZ/FL 1 & 2
- Above bits are in reduced shank except T40, H6, flat: 6, 7, 8 in full hex shank
- 2 pcs. Adapters: 1/4" 50 mm, 1/4" 80 mm
- 8 pcs. sockets: 5, 5.5, 6, 7, 8, 10, 12, 13
- 1 pc of FlexPlus ratcheting driver

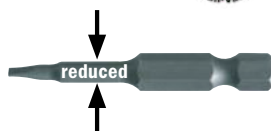

Art. no.	bit	set	kg	PU
104020-1 *	= 50 mm	51-pieces	0,810	1

Ratchet screwdriver set „FlexBagPro“ 37 safety bits, 8 spanner sockets, 5 drill bits, in robust nylon bag.

FlexBag

NEW

Ratchet screwdriver with right/left hand motion. Adjustable operating angle of 180°. Safety and special bit set - top quality S2! The screw handle with a quick change bit system and 2-component handle ensure non-slip and fatigue-free work. The ergonomic form and the soft zones within the pressure area range make a relaxed possible screws.

Contents:

- 1/4" 50 mm torsion bits S-TX (hole), color coded: T10, T10, T15, T15, T20, T25, T27, T30, T40
- 1/4" 50 mm torsion bits Hex, color coded: H3, H4, H5, H6
- 1/4" 50 mm torsion bits PH, color coded: 1, 2, 2, 3
- 1/4" 50 mm torsion bits PZ, color coded: 1, 2, 2, 2
- 1/4" 50 mm torsion bits slot, color coded: 3, 4, 4, 5, 6
- 1/4" 50 mm torsion bits SQ, color coded: 1, 2, 3
- 1/4" 50 mm standard bits PZ/FL: 1, 1, 2, 2
- 1/4" 50 mm standard bits PH/FL: 1, 1, 2, 2
- 8 pcs. sockets: 5, 5.5, 6, 7, 8, 10, 12, 13
- 5 pcs. drills: 2, 3, 4, 5, 6
- 1 pc of „FlexPlus“ ratcheting driver



Art. no.	bit	set	kg	PU
104022-1	= 50 mm	51-pieces	0,810	1

Socket sets



Spanners

Double ended spanners acc. to DIN 3110

chrome vanadium steel, chrome plated, head polished, jaw position 15°



Art. no.	TL	WS	strength	kg	PU
110090	120	6 - 7	3,2	0,240	1
110092	140	8 - 9	3,5	0,340	1
110094	157	10 - 11	4,0	0,590	1
110096	172	12 - 13	4,5	0,057	1
110100	190	14 - 15	5,0	0,760	1
110104	205	16 - 17	5,5	0,144	1
110108	223	18 - 19	6,0	0,182	1
110112	250	21 - 23	7,0	0,212	1
110114	250	24 - 26	7,0	0,273	1
110120	302	27 - 32	8,2	0,519	1

Double ended spanners set acc. to DIN 3110

chrome vanadium steel, chrome plated, head polished, jaw position 15°, plastic holder included.



Art. no.	WS	set	kg	PU
110130	6-22	8-pieces	0,940	1
110132	6-32	12-pieces	2,353	1

Double ended ring spanners to DIN 838

chrome vanadium steel, chrome plated, head polished, ring jaw position 75°



Art. no.	TL	WS	kg	PU
110140	170	6 - 7	0,035	1
110142	185	8 - 9	0,066	1
110144	205	10 - 11	0,075	1
110146	220	12 - 13	0,107	1
110148	240	14 - 15	0,154	1
110152	265	16 - 17	0,175	1
110154	280	18 - 19	0,297	1
110160	335	24 - 26	0,468	1
110164	370	27 - 32	0,611	1

Double ended ring spanner sets DIN 838

chrome vanadium steel, chrome plated, head polished, ring jaw position 75°, in paper box



Art. no.	WS	set	kg	PU
110170	6-22	8-pieces	1,289	1
110172	6-32	12-pieces	2,451	1

Combination spanners similar to DIN 3113

chrome vanadium steel, chrome plated, head polished, jaw position 15°, ring jaw position 75°



Art. no.	TL	WS	kg	PU
110180	100	6	0,016	1
110182	110	7	0,021	1
110184	120	8	0,028	1
110186	130	9	0,036	1
110188	140	10	0,043	1
110190	150	11	0,058	1
110192	160	12	0,061	1
110194	170	13	0,081	1
110196	180	14	0,075	1
110198	190	15	0,087	1
110202	210	17	0,160	1
110204	220	18	0,164	1
110206	230	19	0,187	1
110212	260	22	0,266	1
110216	280	24	0,316	1
110222	310	27	0,401	1

Combination spanners similar to DIN 3113

chrome vanadium steel, chrome plated, head polished, jaw position 15°, ring jaw position 75°, plastic holder included.



Art. no.	WS	set	kg	PU
110250 *	6-22	12-pieces	1,144	1

Combination spanners similar to DIN 3113

chrome vanadium steel, chrome plated, head polished, jaw position 15°, ring jaw position 75°, in roll bag with eyes for hanging.



Art. no.	WS	set	kg	PU
110252	6-27	16-pieces	1,948	1

Open-jawed ring wrench with ratch function

Open-jawed ring wrench with ratch function made from chromium-vanadium steel, chromed surface, polished, fine-toothed, 72 teeth, swing angle 5°, DIN 3113, ISO 3318, in a practical plastic box with metal catch, wrench size 8 - 9 - 10 - 12 - 13 - 14 - 17 - 19 mm



Art. no.	WS	set	kg	PU
110900 *	8-19	8-piece	1,255	1

Open-jawed ring wrench with ratch function

made from chromium-vanadium steel, chromed surface, polished, fine-toothed, 72 teeth, swing angle 5°, DIN 3113, ISO 3318



Art. no.	TL	WS	kg	PU
110900/8	134	8	0,030	1
110900/9	152	9	0,060	1
110900/10	157	10	0,060	1
110900/12	167	12	0,080	1
110900/13	175	13	0,100	1
110900/14	190	14	0,120	1
110900/17	223	17	0,180	1
110900/19	245	19	0,200	1

„Flex“ hinged ratchet combination wrench set

Hinged ratchet combination wrench set made of chrome vanadium steel, chromium plated surface, polished, fine-toothed, 72 teeth, with hinge, 180° swivelling head, DIN 3113, ISO 3318, in a practical plastic box with metal catch.

Contents:

Wrench sizes 8 - 9 - 10 - 12 - 13 - 14 - 17 - 19 mm

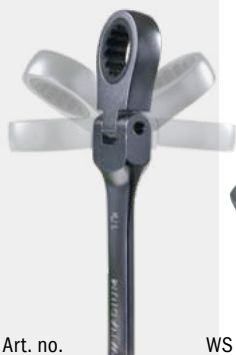

Art. no.	WS	set	kg	PU
110902 *	8-19		1,255	1

„Flex“ hinged ratchet combination wrench

made of chrome vanadium steel, chromium plated surface, polished, fine-toothed, 72 teeth, with hinge, 180° swivelling head, DIN 3113, ISO 3318

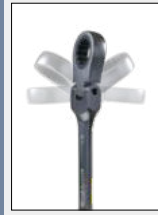

Art. no.	TL	WS	kg	PU
110902/8	140	8	0,041	1
110902/9	148	9	0,050	1
110902/10	162	10	0,068	1
110902/12	175	12	0,093	1
110902/13	178	13	0,105	1
110902/14	190	14	0,123	1
110902/17	227	17	0,189	1
110902/19	246	19	0,253	1

Ratchet wrench 4 in 1

4 in 1 | The ratchet wrench is suitable for 4 different female screw sizes.

- sizes: 8 x 10 mm and 12 x 13 mm 10 x 13 mm and 17 x 19 mm
- fine-tooth 72 teeth of the 2 ratchets, swing angle 3°
- switch-over function of the ratchets for clockwise and anti-clockwise turning
- thanks to the 12-fold teeth, 4, 6 and 12-edged screws and almost round screw nuts can be released easily
- chrome-vanadium steel, chrome-plated
- very durable



Art. no.	size	TL	kg	PU
110780	8x10 12x13	150	0,185	1
110782	10x13 17x19	200	0,205	1

Adjustable single-head wrench

Adjustable single-head wrench with ratch function made from chromium-vanadium steel, forged, chromed, DIN 3117, handle made from TPR, with lasered measuring scale



Art. no.	size	TL	kg	PU
110590	6-19	150	0,160	1
110592 *	9-24	200	0,342	1
110594	10-29	240	0,400	1
110596	10-34	300	0,634	1

haupa®

...convincing solutions

Spanners

Adjustable single-head wrench with ratch function

Adjustable single-head wrench with ratch function made from chromium-vanadium steel, fast and effective working, use of singlehead wrench does not need to be discontinued, forged, chromed, DIN 3117, handle made from TPR, with lasered measuring scale, mounting with anti-theft device and function test



Art. no.	size	TL	kg	PU
110583	6-19	150	0,160	1
110585	9-24	200	0,342	1

Express wrench M10

Installation wrench for express and screw bolts with centre element with interior thread for screw bolts sized M10, for the fixture of sinks and corner valves. An integrated spherical seat ensures easy removal of the wrench from the screw bolt. Made from chrome-vanadium steel. For craft and industrial use.



Art. no.	size	TL	kg	PU
110798	17-19	223	0,238	1



1/4"

Socket sets

Socket set

1/4"

chrome vanadium steel, industrial quality, black plastic case with metal catch, 1/4".

Contents:

12 Sockets: 4 - 4.5 - 5 - 5.5 - 6 - 7 - 8 - 9 - 10 - 11 - 12 - 13 mm, 1 ratchet handle, 72 gears with quick release function, 14 insert bit socket PH: 1 - 2 - 3, HX: 3 - 4 - 5 - 6 - 8, TX: 10 - 15 - 20 - 25 - 27 - 30, 1 flexible extension bar, 2 extension bars 50 & 100 mm, 1 universal joint, 1 sliding adapter 3/8" x 1/4" for extension bar work as T handle, 1 spinner handle for screwdriver



Art. no.	set	kg	PU
110674 *	33-pieces	1,051	1

Reversible ratchet 1/4"

1/4"

Material: Cr-V; Cr-Moly steel | Industrial quality | Standards: DIN 3122; ISO 3315 | Finishing: Silver mat finished | Torsion: 30% higher than DIN | Life-Time: 30k circle times



Art. no.	drive	TL	kg	PU
110674/K	1/4"	140	0,118	1

Extension 1/4"

1/4"

Material: Cr-V 50BV30 steel | Industrial quality | Standards: DIN 3123; ISO 3316 | Finishing: Silver mat finished | Torsion: 30% higher than DIN | Life-Time: 30k circle times at 35% of DIN



Art. no.	drive	TL	kg	PU
110700	1/4"	50	0,024	1
110701	1/4"	100	0,063	1

Flexible extension bar 1/4"

1/4"

Material: Chrom-Vanadium-Stahl, Industriequalität



Art. no.	drive	TL	kg	PU
110702	1/4"	100	0,059	1

Sockets 1/4"

1/4"

Material: Cr-V 50BV30 steel | Industrial quality | Standards: DIN 3124; ISO 2725 | Finishing: Silver mat finished | Profile: hexagonal | Torsion: 30-50% (depends on size) higher than DIN | Life-Time: 200k circle times at 35% of DIN | square drive



Art. no.	WS	kg	PU
110703/4	4	0,010	1
110703/45	4,5	0,010	1
110703/5	5	0,010	1
110703/55	5,5	0,011	1
110703/6	6	0,011	1
110703/7	7	0,014	1
110703/8	8	0,012	1
110703/9	9	0,016	1
110703/10	10	0,016	1
110703/11	11	0,024	1
110703/12	12	0,024	1
110703/13	13	0,025	1

Sliding adapter 3/8" x 1/4"

3/8" 1/4"

Material: Cr-V 50BV30 steel | Industrial quality | Standards: DIN 3122; ISO 3315 | Finishing: Silver mat finished | Torsion: 30% higher than DIN | Life-Time: 30k circle times at 35% of DIN | for extension bar work as T handle



Art. no.	kg	PU
110706	0,029	1

Spinner handle for screwdriver 1/4"

1/4"

Material: Chrom-Vanadium-Stahl, Industriequalität



Art. no.	drive	kg	PU
110725	1/4"	0,064	1

Universal joint 1/4"

1/4"

Material: Cr-V 50BV30 steel | Industrial quality | Standards: DIN 3122; ISO 3315 | Finishing: Silver mat finished | Torsion: 40% higher than DIN | Life-Time: 40k circle times at 35% of DIN



Art. no.	kg	PU
110726	0,024	1

Insert bit sockets PH 1/4"

1/4"

Material: Sockets: Cr-V steel; Bits: S2 Xtra Moly steel | Industrial quality | Standards: DIN / ISO standards | Finishing: Silver mat finished



Art. no.	size	kg	PU
110711	1	0,015	1
110727	2	0,015	1
110728	3	0,016	1

Insert bit sockets HEX 1/4"

1/4"

Material: Sockets: Cr-V steel; Bits: S2 Xtra Moly steel | Industrial quality | Standards: DIN / ISO standards | Finishing: Silver mat finished



Art. no.	WS	kg	PU
110729	3	0,015	1
110747	4	0,015	1
110749	5	0,016	1
110754	6	0,018	1
110718	8	0,018	1

Insert bit sockets TX 1/4"

1/4"

Material: Sockets: Cr-V steel; Bits: S2 Xtra Moly steel | Industrial quality | Standards: DIN / ISO standards | Finishing: Silver mat finished



Art. no.	size	kg	PU
110719	10	0,013	1
110720	15	0,015	1
110721	20	0,015	1
110722	25	0,015	1
110723	27	0,015	1
110724	30	0,015	1

Insert bit sockets slot 1/4"

1/4"

Material: Sockets: Cr-V steel; Bits: S2 Xtra Moly steel | Industrial quality | Standards: DIN / ISO standards | Finishing: Silver mat finished



Art. no.	BL	kg	PU
110759	5,5	0,015	1
110760	4	0,014	1

Socket set

3/8"

chrome vanadium steel, industrial quality, black plastic case with metal catch, 3/8".

Contents:

18 Sockets: 6 - 7 - 8 - 9 - 10 - 11 - 12 - 13 - 14 - 15 - 16 - 17 - 18 - 19 - 20 - 21 - 22 - 24 mm, 1 ratchet handle, 72 gears with quick release function, 1 universal joint, 1 sliding adapter 1/2" x 3/8" for extension bar work as T handle, 2 spark plug sockets 16 & 21 mm, 3 extension bars 20 - 75 - 150 mm



Art. no.	set	kg	PU
110676	26-pieces	2,309	1

Reversible ratchet 3/8"

3/8"

Material: Cr-V; Cr-Moly steel | Industrial quality | Standards: DIN 3122; ISO 3315 | Finishing: Silver mat finished | Torsion: 30% higher than DIN | Life-Time: 30k circle times



Art. no.	drive	TL	kg	PU
110676/K	3/8"	185	0,260	1

Extension 3/8"

3/8"

Material: Cr-V 50BV30 steel | Industrial quality | Standards: DIN 3123; ISO 3316 | Finishing: Silver mat finished | Torsion: 30% higher than DIN | Life-Time: 30k circle times at 35% of DIN



Art. no.	drive	TL	kg	PU
110731	3/8"	20	0,045	1
110733	3/8"	75	0,075	1
110735	3/8"	150	0,143	1

Spark plug sockets 3/8"

3/8"

Material: Cr-V 50BV30 steel | Industrial quality | Standards: DIN 3124; ISO 2725 | Finishing: Silver mat finished | Profile: hexagonal | Torsion: 30-50% (depends on size) higher than DIN | Life-Time: 200k circle times at 35% of DIN | square drive



Art. no.	WS	kg	PU
110738	16	0,092	1
110739	21	0,139	1

Sockets 3/8"

3/8"

Material: Cr-V 50BV30 steel | Industrial quality | Standards: DIN 3124; ISO 2725 | Finishing: Silver mat finished | Profile: hexagonal | Torsion: 30-50% (depends on size) higher than DIN | Life-Time: 200k circle times at 35% of DIN | square drive



Art. no.	WS	kg	PU
110737/6	6	0,019	1
110737/7	7	0,020	1
110737/8	8	0,021	1
110737/9	9	0,023	1
110737/10	10	0,023	1
110737/11	11	0,024	1
110737/12	12	0,024	1
110737/13	13	0,024	1
110737/14	14	0,031	1
110737/15	15	0,040	1
110737/16	16	0,035	1
110737/17	17	0,046	1
110737/18	18	0,061	1
110737/19	19	0,056	1
110737/20	20	0,066	1
110737/21	21	0,060	1
110737/22	22	0,078	1
110737/24	24	0,085	1

Sliding adapter 1/2" x 3/8"

1/2" 3/8"

Material: Cr-V 50BV30 steel | Industrial quality | Standards: DIN 3122; ISO 3315 | Finishing: Silver mat finished | Torsion: 30% higher than DIN | Life-Time: 30k circle times at 35% of DIN | for extension bar work as T handle



Art. no.	kg	PU
110741	0,070	1

Universal joint 3/8"

3/8"

Material: Cr-V 50BV30 steel | Industrial quality | Standards: DIN 3122; ISO 3315 | Finishing: Silver mat finished | Torsion: 40% higher than DIN | Life-Time: 40k circle times at 35% of DIN



Art. no.	kg	PU
110745	0,067	1

3/8" internal hexagonal bolt set

3/8"

7-piece, in roll-up case with loop for hanging up, **extra long 150 mm**, with ball end for challenging installation positions

Sizes: 3 - 4 - 5 - 6 - 7 - 8 - 10



Art. no.	set	kg	PU
111737	7-pieces	0,067	1

Socket set

1/2"

chrome vanadium steel, industrial quality, black plastic case with metal catch, 1/2".

Contents:

20 Sockets: 10 - 11 - 12 - 13 - 14 - 15 - 16 - 17 - 18 - 19 - 20 - 21 - 22 - 23 - 24 - 26 - 27 - 28 - 30 - 32 mm, 1 ratchet handle, 72 gears with quick release function, 1 extension bar, safety locking type 250 mm, 1 extension bar 125 mm, 1 sliding T-bar 300 mm, 1 universal joint, 1 sliding adapter 3/8" x 1/2" for extension bar work as T handle



Art. no.	set	kg	PU
110677	25-pieces	4,739	1

Reversible ratchet 1/2"

1/2"

Material: Cr-V; Cr-Moly steel | Industrial quality | Standards: DIN 3122; ISO 3315 | Finishing: Silver mat finished | Torsion: 30% higher than DIN | Life-Time: 30k circle times



Art. no.	drive	TL	kg	PU
110677/K	1/2"	260	0,560	1

Extension 1/2"

1/2"

Material: Cr-V 50BV30 steel | Industrial quality | Standards: DIN 3123; ISO 3316 | Finishing: Silver mat finished | Torsion: 30% higher than DIN | Life-Time: 30k circle times at 35% of DIN



Art. no.	drive	TL	kg	PU
110751	1/2"	75	0,137	1
110752	1/2"	125	0,200	1
110753	1/2"	250	0,388	1

Sockets 1/2"

1/2"

Material: Cr-V 50BV30 steel | Industrial quality | Standards: DIN 3124; ISO 2725 | Finishing: Silver mat finished | Profile: hexagonal | Torsion: 30-50% (depends on size) higher than DIN | Life-Time: 200k circle times at 35% of DIN | square drive



Art. no.	WS	kg	PU
110754/10	10	0,046	1
110754/11	11	0,051	1
110754/12	12	0,052	1
110754/13	13	0,053	1
110754/14	14	0,055	1
110754/15	15	0,052	1
110754/16	16	0,052	1
110754/17	17	0,060	1
110754/18	18	0,060	1
110754/19	19	0,066	1
110754/20	20	0,066	1
110754/21	21	0,080	1
110754/22	22	0,094	1
110754/24	24	0,100	1
110754/26	26	0,120	1
110754/27	27	0,150	1
110754/28	28	0,165	1
110754/30	30	0,177	1
110754/32	32	0,206	1

Spark plug sockets 1/2"

1/2"

Material: Cr-V 50BV30 steel | Industrial quality | Standards: DIN 3124; ISO 2725 | Finishing: Silver mat finished | Profile: hexagonal | Torsion: 30-50% (depends on size) higher than DIN | Life-Time: 200k circle times at 35% of DIN | square drive



Art. no.	WS	kg	PU
110755	16	0,092	1
110756	21	0,141	1

Sliding adapter 3/8" x 1/2"

3/8" 1/2"

Material: Cr-V 50BV30 steel | Industrial quality | Standards: DIN 3122; ISO 3315 | Finishing: Silver mat finished | Torsion: 30% higher than DIN | Life-Time: 30k circle times at 35% of DIN | for extension bar work as T handle



Art. no.	kg	PU
110757	0,069	1

Universal joint 1/2"

1/2"

Material: Cr-V 50BV30 steel | Industrial quality | Standards: DIN 3122; ISO 3315 | Finishing: Silver mat finished | Torsion: 40% higher than DIN | Life-Time: 40k circle times at 35% of DIN



Art. no.	kg	PU
110758	0,152	1

Socket sets

Socket set

1/2" 1/4"

chrome vanadium steel, industrial quality, black plastic case with metal catch.

Contents:

1/4": 12 Sockets 4 - 4.5 - 5 - 5.5 - 6 - 7 - 8 - 9 - 10 - 11 - 12 - 13 mm, 1 ratchet handle, 1 universal joint, 1 sliding adapter 3/8" x 1/4" for extension bar work as T handle, 2 extension bars 50 + 150 mm, 1 spinner handle for screwdriver, 12 insert bit sockets: PH: 1-2, HX: 3 - 4 - 5 - 6, FD: 5.5 - 7, TX: 20 - 25 - 27 - 30, 5 Hex keys: 1.25 - 1.5 - 2.0 - 2.5 - 3.0 mm

1/2": 13 sockets 10 - 11 - 12 - 13 - 14 - 15 - 17 - 19 - 22 - 24 - 27 - 30 - 32 mm, 1 ratchet handle, 2 extension bars 75 + 250 mm, 1 sliding adapter 3/8" x 1/2" for extension bar work as T handle, 2 plug sockets, 1 universal joint



Art. no.	set	drive	kg	PU
110678 *	53-pieces	1/4"+1/2"	4,385	1

SysCon

„SocketMax“ 1/2", 1/4"

SysCon

chrome vanadium steel, industrial quality, in ABS plastic box, including HAUPA „FlexPlus“ ratchet screwdriver.

Contents:

- 220370 ABS plastic box „SysCon S“
- 2 Sockets 1/4" 4-4.5-5-5.5-6-7-8-9-10-11-12-13 mm
- 2 Extensions 1/4" 50 - 150mm
- 1 Adapter 3/8" x 1/4" for sliding handle
- 1 Kardanjoint 1/4"
- 1 Bit adapter 1/4"
- 1 Reversible ratchet 1/4"
- 13 Sockets 1/2" 10-11-12-13-14-15-17-19-22-24-27-30-32 mm
- 2 Extensions 1/2" 75 - 250 mm
- 1 Adapter 3/8" x 1/2" for sliding handle
- 1 Kardanjoint 1/2"
- 1 Reversible ratchet 1/2"
- 1 Ratchet screwdriver „Flex“
- 2 Adapter 50 - 80 mm
- 4 Bit 1/4" 50 mm PH 0 - 1 - 2 - 3
- 4 Bit 1/4" 50 mm PZ 0 - 1 - 2 - 3
- 2 Bit 1/4" 50 mm PZ/FL 1 - 2
- 4 Bit 1/4" 50 mm SL 3 - 4 - 5 - 6 mm
- 6 Bit 1/4" 50 mm hexagon 2 - 2.5 - 3 - 4 - 5 - 6



Art. no.	set	empty	kg	PU
220600	55-pieces	220370	6,000	1

„SocketFlex“ socket wrench box

1/2" 1/4"

Chrome vanadium steel, industrial quality, black plastic case with metal catch, including HAUPA „FlexPlus“ ratchet screwdriver.

Contents:



- 12 1/4" socket wrench inserts 4 - 4,5 - 5 - 5,5 - 6 - 7 - 8 - 9 - 10 - 11 - 12 - 13 mm
- 2 1/4" 50 and 150 mm extensions
- 1 3/8" x 1/4" adapter for extending for use as a T-handle
- 1 1/4" universal joint
- 1 bit adapter 4-edge to 1/4" hexagonal
- 1 1/4" reversible wratchet
- 13 1/2" socket wrench inserts 10 - 11 - 12 - 13 - 14 - 15 - 17 - 19 - 22 - 24 - 27 - 30 - 32 mm
- 2 1/2" 75 and 250 mm extensions
- 1 3/8" x 1/2" adapter for extending for use as a T-handle
- 1 1/2" universal joint
- 1 1/2" reversible ratchet
- 1 Flex ratchet screwdriver
- 1 adapter 1/4" x 1/4" x 50 mm
- 1 adapter 1/4" x 1/4" x 80 mm
- 4 bits 1/4", 50 mm, PH 0 - 1 - 2 - 3
- 4 bits 1/4", 50 mm, PZ 0 - 1 - 2 - 3
- 2 bits 1/4", 50 mm, PZ/FL 1 - 2
- 4 bits 1/4", 50 mm, slot 3 - 4 - 5 - 6 mm
- 6 bits 1/4", 50 mm, hexagon socket 2 - 2,5 - 3 - 4 - 5 - 6



Art. no.	set	drive	kg	PU
110672	59-pieces	1/4"+1/2"	4,500	1

INFO

Torque wrench

Industrial quality

- With built-in changeover ratchet, accuracy +/- 3%,
- Material: Chrome-Vanadium steel DIN-3122; ISO 6789
- Measuring range from 5 - 25 Nm, 21 - 119 Nm, 42 - 210 Nm
- With viewing window display and locking mechanism
- Easy to read scale
- In impact-proof storage box



Torque wrenches

Torque wrenches

TQ 3/8"

reversible ratchet system, +/- 3%, Chrome-Vanadium-Steel DIN-3122; ISO 6789



TQ

Art. no.	drive	Nm	kg	PU
110605	3/8"	5 - 50	1,000	1

Torque wrenches

TQ 3/8"

reversible ratchet system, +/- 3%, Chrome-Vanadium-Steel DIN-3122; ISO 6789



TQ

Art. no.	drive	Nm	kg	PU
110608	3/8"	20 - 120	1,500	1

Torque wrenches

TQ 1/2"

reversible ratchet system, +/- 3%, Chrome-Vanadium-Steel DIN-3122; ISO 6789



TQ

Art. no.	drive	Nm	kg	PU
110610	1/2"	20 - 120	1,500	1

Torque wrenches

TQ 1/4"

reversible ratchet system, +/- 3%, Chrome-Vanadium-Steel DIN-3122; ISO 6789



TQ

Art. no.	drive	Nm	kg	PU
110607 *	1/4"	5 - 25	1,000	1

SysCon Socket sets

Torque wrenches

TQ 1/2"

reversible ratchet system, +/- 3%, Chrome-Vanadium-Steel DIN-3122; ISO 6789



TQ

Art. no.	drive	Nm	kg	PU
110609	1/2"	42 - 210	1,750	1

SysCon socket wrench set "Torque" 1/2"

SysCon

chrome vanadium steel, industrial quality, in ABS plastic box.

Contents:



- 1 220370 ABS plastic box "SysCon S"
- 17 sockets 1/2" 8 - 10 - 11 - 12 - 13 - 14 - 15 - 16 - 17 - 19 - 21 - 22 - 23 - 24 - 27 - 30 - 32 mm
- 5 sockets 1/2" Tx, long version T30, T40, T45, T50, T55
- 4 sockets 1/2" Hex, long version 8, 10, 12, 14 without hole
- 2 extension bar 1/2", 75 and 250 mm
- 1 adapter 3/8" x 1/2" for extension bar work as T-handle
- 1 universal joint 1/2"
- 1 reversible ratchet 1/2"
- 1 torque wrenches 1/2", 21 - 119 Nm



TQ 1/2"

Art. no.	set	empty	kg	PU
220642	32-pieces	220370	4,300	1

SysCon socket wrench set "Torque" 1/4"

SysCon

chrome vanadium steel, industrial quality, in ABS plastic box, including HAUPA „FlexPlus“ ratchet screwdriver.

Contents:



- 1 220370 ABS plastic box "SysCon S"
- 12 sockets 1/4" 4 - 4.5 - 5 - 5.5 - 6 - 7 - 8 - 9 - 10 - 11 - 12 - 13 mm
- 5 sockets 1/4" Tx, long version T20, T25, T27, T30, T40
- 4 sockets 1/4" Hex, long version 4, 5, 6, 8 without hole
- 2 extension bar 1/4", 50 and 150 mm
- 1 adapter 3/8" x 1/4" for extension bar work as T-handle
- 1 universal joint 1/4"
- 1 bit adapter 1/4"
- 1 reversible ratchet 1/4"
- 1 torque wrenches 1/4", 5 - 25 Nm
- 1 ratchet screwdriver "Flex"
- 2 adapter 50 and 80 mm
- 4 bits 1/4" 50 mm PH 0 - 1 - 2 - 3
- 4 bits 1/4" 50 mm PZ 0 - 1 - 2 - 3
- 2 bits 1/4" 50 mm PZ/FL 1 - 2
- 4 bits 1/4" 50 mm SQ 3 - 4 - 5 - 6 mm
- 6 bits 1/4" 50 mm hexagonal 2 - 2.5 - 3 - 4 - 5 - 6



TQ 1/4"

Art. no.	set	empty	kg	PU
220640	51-pieces	220370	3,900	1

haupa®

...convincing solutions

INFO

Switch cabinet keys

Industrial quality

HAUPA Universal keys are ideal for use in building technology.

They are small and lightweight, yet through their zinc die-cast construction they are very robust and stable. The HUPkeys are especially suitable for locking systems in electrical engineering as well as for special applications in construction, plumbing, ventilation and air conditioning technology.



Switch cabinet key, „HUPkey“ with converting bit

Inside square 6 - 7 mm, 8 - 9 mm,
Outside square 5 - 10 mm, two-way 3 - 5 mm,
Triangle socket 7 - 9 mm, triangle socket 11 mm,
SI converting bit for slotted and cross-headed screws
Including 5 mm inside square and crescent on chain

Not available in GB and FR!

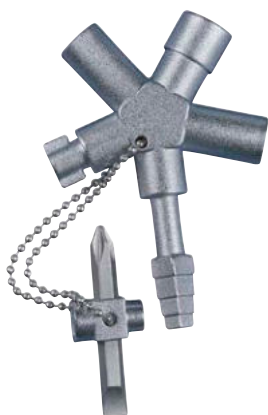

Art. no.	kg	PU
110692	0,145	1

Switch cabinet keys

Switch cabinet key, „HUPkey“

Inside square 6 - 7 mm, 8 - 9 mm,
Outside square 5 - 10 mm, two-way 3 - 5 mm,
Triangle socket 7 - 9 mm, triangle socket 11 mm and chain



Art. no.	kg	PU
110691	0,115	1

Converting bit for bleeding

SI converting bit for slotted and cross-headed screws
Including 5 mm inside square and crescent on chain

Not available in GB and FR!



Art. no.	kg	PU
110693	0,030	1

Universal switch cabinet key with crescent, „HUPkey“

Inside square 6 - 7 mm, 8 - 9 mm, crescent,
Two-way 3 - 5 mm, triangle socket 7 - 9 mm,
Triangle socket 11 mm, SI converting bit for slotted
and cross-headed screws on chain

Not available in GB and FR!



Art. no.	kg	PU
110697	0,094	1

Switch cabinet keys

Spanners for switch cabinet key, „HUPkey Uni“



Spanner for switch cabinets with push construction, bitholder and bit on chain, external square 7 + 8 mm, inside square 6, 7, 8, 9 mm, double size 3 - 5 mm, inside threesquare 7, 8, 9, 10, 11 mm

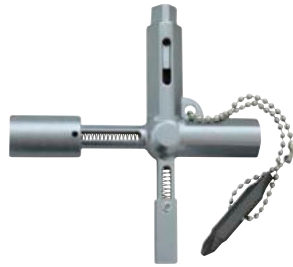

Not available in GB and FR!



Art. no.	kg	PU
110698	0,105	1

Spanners for switch-cabinets, „HUPkey“

made of metal for high torques, small size, low weight, with chain inside square 6 mm, inside square 7 - 8 mm, inside threesquare 7 - 8 mm, double size 3 - 5 mm



Art. no.	size	kg	PU
110696 *	72 x 72	0,059	1



haupa[®]

...convincing solutions

HAUPA GmbH & Co. KG, Koenigstr. 165-169, 42853 Remscheid, Phone: +49 (0)2191 8418-0, Fax: +49 (0)2191 8418-840, sales@haupa.com

Pliers



INFO

2-component pliers

Industrial quality

Pliers range with 2-component handles made of highquality, non-slip, thermoplastic elastomer.

High leverage | perfected cutting force performance

High leverage pliers offer power saving of up to 50%.



Pliers Black Line

Combination pliers DIN ISO 5746

alloyed carbon steel, forged and annealed, cutting edges induction hardened, with 2 component plastic handle with hand protection, chrome plated, for soft wire and hard wire, **leveraged, perfected cutting force performance.**



Art. no.	TL	soft	hard	kg	PU
210052	160	4,0	2,0	0,197	1
210053 *	180	4,0	2,2	0,286	1
210054	200	4,2	2,5	0,410	1

Side cutters DIN ISO 5749

alloyed carbon steel, forged and annealed, cutting edges induction hardened, with 2 component plastic handle with hand protection, chrome plated, for soft wire and hard wire, **leveraged, perfected cutting force performance.**



Art. no.	TL	soft	hard	kg	PU
210067	140	4,0	1,8	0,172	1
210068 *	160	4,0	2,0	0,237	1
210069	180	4,0	2,0	0,237	1

Heavy duty side cutters DIN ISO 5749

alloyed carbon steel, forged and annealed, cutting edges induction hardened, with 2 component plastic handle with hand protection, chrome plated, for soft wire and hard wire.



Art. no.	TL	soft	hard	kg	PU
210156	160	4,0	2,7	0,264	1
210157	180	4,0	2,7	0,264	1

Heavy duty side cutters DIN ISO 5749

alloyed carbon steel, forged and annealed, cutting edges induction hardened, with 2 component plastic handle with hand protection, chrome plated, for soft wire and hard wire, **leveraged, perfected cutting force performance.**



Art. no.	TL	soft	hard	kg	PU
210158 *	200	4,2	3,0	0,326	1



Chrome plated, cutting edges inductive hardened

leveraged

slipping protection

slim shape for easy handling

reinforced handle for maximum cutting force

Pliers Black Line

Long flat nose pliers DIN ISO 5745

alloyed carbon steel, forged and annealed, cutting edges induction hardened, with 2 component plastic handle with hand protection, chrome plated



Art. no.	TL	kg	PU
210313	160	0,155	1

Long round nose pliers DIN ISO 5745

alloyed carbon steel, forged and annealed, cutting edges induction hardened, with 2 component plastic handle with hand protection, chrome plated



Art. no.	TL	kg	PU
210350	160	0,153	1

Long chain nose pliers DIN ISO 5745

with side cutter, straight, alloyed carbon steel, forged and annealed, cutting edges induction hardened, for soft wire and hard wire, with 2 component plastic handle with hand protection, chrome plated, **leveraged, perfected cutting force performance.**



Art. no.	TL	form	kg	PU
210394	170	straight	0,154	1
210396 *	200	straight	0,253	1

Long chain nose pliers DIN ISO 5745

with side cutter, 45° angled nose, alloyed carbon steel, forged and annealed, cutting edges induction hardened, for soft wire and hard wire, with 2 component plastic handle with hand protection, chrome plated, **leveraged, perfected cutting force performance.**



Art. no.	TL	form	kg	PU
210397	160	45°	0,251	1
210398 *	200	45°	0,251	1

Wire stripping pliers

alloyed carbon steel C 45, forged and annealed, cutting edges induction hardened, with 2 component plastic handle with hand protection, chrome plated



Art. no.	TL	mm ²	kg	PU
210644	160	0,6-10	0,196	1

Water pump pliers DIN ISO 8976

chrome vanadium steel, forged and annealed, curved jaws, gripping chuck hardened, self-locking nut, finger protection, with 2 component plastic handle with hand protection, chrome plated



Art. no.	TL	kg	PU
210584 *	240	0,368	1

Water pump pliers DIN ISO 8976

chrome vanadium steel, forged and annealed, curved jaws, gripping chuck hardened, titan-plated, dipped, setting at touch of a button, safe engaging



Art. no.	TL	kg	PU
210616	170	0,185	1
210617 *	240	0,330	1
210618	300	0,545	1

Pliers set

Contents:

- 1 combination pliers 180 mm
- 1 diagonal cutter 160 mm
- 1 long chain nose pliers 200 mm
- 1 wire stripping pliers 160 mm



Art. no.	set	kg	PU
220128	4-pieces	1,044	1

Pliers set

Contents:

- 1 combination pliers 180 mm
- 1 heavy duty diagonal cutter 180 mm
- 1 long chain nose pliers 200 mm
- 1 wire stripping pliers 160 mm



Art. no.	set	kg	PU
220129	4-pieces	1,082	1

haupa®

...convincing solutions

Special pliers

Grip pliers

one jaw straight, one jaw movable, forged of chrome vanadium, a real universal plier for gripping any kind of workpiece, flat round or square, with quick-release lever and adjustable screw



Art. no.	TL	WS	kg	PU
210556	250	0-40	0,518	1

Grip pliers

jaws drop, forged of chrome vanadium, adjustable screw, quick-release lever, half-round jaws, with wire cutter



Art. no.	TL	WS	kg	PU
210562	250	0-40	0,565	1

Pipe wrenches

chrome vanadium steel, polished



Art. no.	TL	WS	tube	kg	PU
210592	320	-45	1"	0,798	1
210594	435	-59	1 1/2"	0,800	1
210596	560	-76	2"	2,460	1

Riveting pliers

made of aluminium-pressure casting, all inner parts made of special alloyed steel and hardened, with 4 exchangeable nozzles 2,4-3-4-5 mm, for blind rivets of aluminium-copper or steel



Art. no.	TL	kg	PU
210770	250	0,552	1

Riveting tool set

in portable plastic box. **Contents:** 1 plier no. 210770, 100 pieces of alu space rivets 4 mm Ø, short-middle-long, 2 twist drills and washers.



Art. no.	TL	kg	PU
210776	250	0,840	1

Electronic pliers

Microelectronic side cutters

without cutting-facet, clearance angle: 50°, with clip, for soft wires up to 0.8 mm²



Art. no.	TL	kg	PU
211708	118	0,069	1

Microelectronic side cutters

without cutting-facet, clearance angle: 21°, with clip, for soft wires up to 1.3 mm²



Art. no.	TL	kg	PU
211720 *	132	0,086	1
211722	158	0,087	1

Tweezers

special design for wafers, long, extra small blades, needle fine top ends, stainless steel, antimagnetism acid resistant



Art. no.	TL	kg	PU
211080	130	0,017	1

INFO

ESD Electronic pliers

Industrial quality

Advantages:

- Ergonomically shaped, non-slip 2-component handle ensures comfortable and precise working
- Special tool steel, forged and tempered, edges hardened (58 ± 2HRC)
- Surface resistance 10.9 Ohm, in accordance with electronics area ESD
- Each mechanism checked
- precision pliers for meticulous assembly work for example in electronics and precision engineering
- for picking up, holding and bending
- model with electric discharging
- precision hinges
- smooth handle surfaces
- low-friction double spring for smooth and steady opening
- handles with two-coloured multi-component handle covers black/green
- special tool steel



Not only people, objects also experience electrostatic charging as a result of movement, friction and being handled.

Such charging can lead to the destruction of endangered components. HAUPA ESD - electronics pliers discharge such energy slowly and in a controlled way.

ESD Electronic needle nose pliers

with wire cutter, special tool steel



Art. no.	TL	form	kg	PU
211850	130	straight	0,091	1

ESD Electronic needle nose pliers, 45° angle

with wire cutter, special tool steel



Art. no.	TL	form	kg	PU
211852	130	45°	0,089	1

ESD Electronic needle nose pliers

straight construction, special tool steel



Art. no.	TL	form	kg	PU
211854	130	straight	0,082	1

ESD Electronic needle nose pliers, 45° angle

45° angle, special tool steel



Art. no.	TL	form	kg	PU
211856	130	45°	0,081	1

ESD Electronic thin needle nose pliers

straight construction, special tool steel



Art. no.	TL	form	kg	PU
211858	140	straight	0,083	1

ESD Electronic thin needle nose pliers, 45° angle

45° angle, special tool steel



Art. no.	TL	form	kg	PU
211860	140	45°	0,084	1

ESD Electronic thin needle nose pliers

straight construction, special tool steel



Art. no.	TL	form	kg	PU
211862	150	straight	0,087	1

ESD Electronic thin needle nose pliers, 45° angle

45° angle, special tool steel



Art. no.	TL	form	kg	PU
211864	150	45°	0,087	1

haupa®

...convincing solutions

ESD Electronic flat nose pliers

Special tool steel



Art. no.	TL	kg	PU
211866	130	0,090	1

ESD Electronic front cutter

Special tool steel



Art. no.	TL	kg	PU
211874	115	0,093	1

ESD Electronic round nose pliers

straight construction, special tool steel



Art. no.	TL	kg	PU
211868	130	0,091	1

ESD Electronic combination pliers

with wire cutter, special tool steel



Art. no.	TL	kg	PU
211876	115	0,077	1

ESD Electronic side cutter

normal construction, head width 14 mm, special tool steel



Art. no.	TL	kg	PU
211870 *	115	0,078	1

ESD Electronic side cutters

slim construction, head width 10 mm, special tool steel



Art. no.	TL	kg	PU
211872	110	0,075	1

ESD Electronic side cutter without cutting-facet

normal construction, head width 14 mm without chamfer, special tool steel



Art. no.	TL	kg	PU
211875 *	115	0,075	1

ESD Electronic pliers set

Special tool steel

Contents:

Art. No. 211862, 211870, 211874, 211876



Art. no.	set	kg	PU
211880	4-pieces	0,585	1

LED lamps/torches and Compact floodlights



INFO

LED lamps/torches

Industrial quality

HAUPA high-performance LED lamps/torches for daily work use

Extremely high illumination performance with minimum battery load thanks to highly modern **CREE LED** bulbs

LED „Mini Torch“



- Compact
- Very small and light
- Extremely high lighting performance
- LED 3 Watt CREE XR-E
- 1xAAA battery



Art. no.	size	kg	PU
130310	Ø 20 x 92,5 mm	0,080	1

LED „Focus Torch“

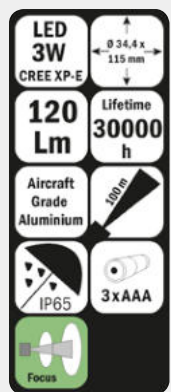

- Adjustable focus for near and far
- LED 3 Watt CREE XP-E
- 3xAAA batteries



Art. no.	size	kg	PU
130312	Ø 34,4 x 115 mm	0,200	1

LED „IP67 Torch“

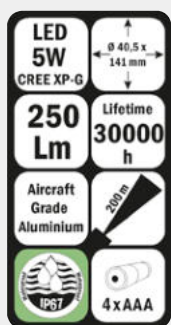

- IP67, dust-tight, protected against brief submersion (water-tight)
- 1 x switch operation 100 % lighting performance
- 2 x switch operation 30 % lighting performance
- LED 5 Watt CREE XP-G
- 4xAAA batteries



Art. no.	size	kg	PU
130314	Ø 40,5 x 141 mm	0,440	1

LED „RC Torch“



- Rechargeable battery, lithium-ion 2200 mAh 3.7 V
- Integrated charging unit
- 1 x switch operation 100 % lighting performance
- 2 x switch operation 30 % lighting performance
- Additional battery holder as backup
- Deep discharge protection
- LED 5 Watt CREE XP-G
- Charging cable 230 Volt, charging cable for automobile
- Battery holder (battery operation is an alternative)



Art. no.	size	kg	PU
130316	Ø 40,5 x 180 mm	0,440	1

Holster for LED torches

Suitable for item numbers: 130312, 130314



Art. no.	width	depth	height	kg	PU
130322	30	10	100	0,180	1



LED lamps/torches

LED „Pen Torch“



- Illumination range: 50 m
- 50 Lm
- LED 1 Watt CREE
- With clip
- 2xAAA batteries



Art. no.	size	kg	PU
130328 *	∅ 14 x 143 mm	0,200	1

Mini working light „HUPlight4“

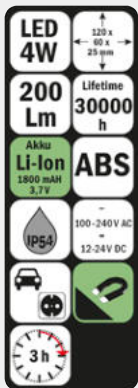

- Rechargeable battery, lithium-ion 1800 mAh 3.7 V
- LED 4 Watt
- Approximately 200 Lumen lighting performance
- Approximately 3 hours lighting performance
- Lamp may be charged using the micro USB port
- Stand may be angled
- Dual magnetic bracket
- Hook for securing and hanging
- Can be used and carried everywhere



Art. no.	Watt	size	kg	PU
130336	4	60 x 25 x 120 mm	0,260	1

LED working light „HUPlight10+3“



- Integrated Li-Ion 3.7V / 6.7Ah battery
- **10 watt + 3 watt LED**
- High-quality plastic housing
- For use inside and out, splashproof acc. to IP54
- Extremely bright illumination, 7000K colour temperature
- 220 Lm (3W LED) + 800 Lm (10W LED) luminosity
- Colour rendering 90 CRI (Colour Rendering Index)
- Variable light output, 50% | 100%
- Operating time
- 10W LED: - Approx. 3 hours with 100% light output
- Approx. 6 hours with 50% light output
- 3W LED: - Approx. 12 hours with 100% light output
- Approx. 24 hours with 50% light output
- 3.5 hours charging time using power unit supplied
- Charger: 100 – 240 V AC plug-in power supply (5V/2A DC)
- 12V KFZ charging cable
- Adjustable magnetic stand
- With hook for hanging
- With belt clip



Art. no.	Watt	size	kg	PU
130348 *	10+3	220 x 57 x 40 mm	0,380	1



haupa[®]

...convincing solutions

LED Headlamps



LED headlamp „HUPflash155“

- 3 W COB LED
- Material: ABS, PC
- Luminosity 155 Lm
- Colour reproduction 90 CRI
- Battery-powered (3 x AAA included in the scope of delivery)
- Variable light intensity, 50% | 100%
- Operating time:
 - approx. 2.5 hours at 100% light intensity
 - approx. 4 hours at 50% light intensity
- Very easy-to-balance headlamp
- Automatically switches on and off, thanks to special **sensor technology**
- Easy to operate e.g. when wearing protective gloves
- **Headband with silicone strips** for secure fastening to work helmets
- Dimensions: 60 x 45 x 38 mm
- Weight: 49 g (without batteries)



Art. no.	Watt	size	kg	PU
130319	3	60 x 45 x 38 mm	0,090	1



LED headlamp „HUPflash155+“

- **3.7 V 1200 mAh lithium polymer battery**
- 3 W COB LED
- Material: ABS, PC
- Light intensity 155 Lm
- Colour reproduction 90 CRI
- Variable light intensity, 50% | 100%
- Operating time:
 - approx. 2.5 hours at 100% light intensity
 - approx. 4 hours at 50% light intensity
- Charging cable (micro USB) included in the scope of delivery
- Charging time approx. 4 hours
- Very easy-to-balance headlamp
- Automatically switches on and off, thanks to special **sensor technology**
- Easy to operate e.g. when wearing protective gloves
- **Headband with silicone strips** for secure fastening to work helmets
- Dimensions: 60 x 45 x 38 mm
- Weight: 73 g



Art. no.	Watt	size	kg	PU
130321	3	60 x 45 x 38 mm	0,073	1

For a good overall view

Work safely thanks to the higher colour rendering index CRI



We all know the problem... Poorly lit work areas - the colours of the individual wires in the cables are hard to differentiate.

Now HAUPA has the solution: work lights and compact spots with a higher colour rendering index CRI.

The new lamps have a CRI of 90. In comparison: daylight has a value of 100. This makes colours more natural and much easier to distinguish thanks to the higher brilliance.

The result: improved safety for professionals at work. The colours are easier to recognise and work can be performed much faster.

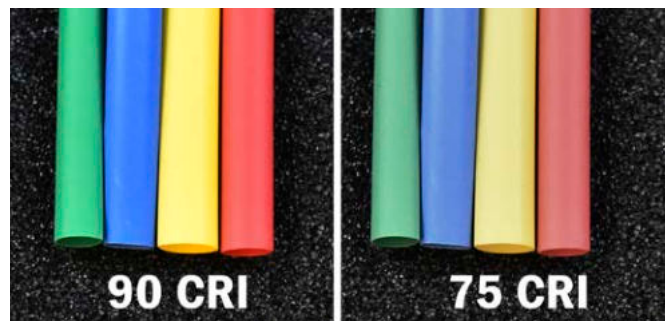

CRI 90 makes the difference. Conventional work lamps have a CRI of 75.





LED headlamp „HUPflash250“

CREE XML2	28 x 107 mm
250 Lm	Lifetime 30000 h
Akku Li-Ion 2000 mAh 3.7V	kg 149 g
2,5h	AI
micro USB	
CRI 90	50% 100%

- **Li-Ion battery 18650 3.7 V 2000 mAh**
- Can be used as a headlamp or a torch
- CREE XML2 LED
- Light intensity 250 Lm
- Colour reproduction 90 CRI
- 3 different light intensity levels + flash + SOS mode
- **Stable housing, made of aluminium**, copper and stainless steel
- Variable light intensity, 50% | 100%
- Operating time:
 - approx. 2.5 hours at 100% light intensity
 - approx. 4 hours at 50% light intensity
- Charging time approx. 4 hours
- **With pocket clip** for attachment to bags and belts
- **Headband with silicone strips** for secure fastening to work helmets
- **Magnetic stand**
- Charging cable (micro USB) included in the scope of delivery
- Dimensions: 28 x 107 mm
- Weight: 149 g



Art. no.	Watt	size	kg	PU
130323	XML2	28 x 107 mm	0,149	1

Compact LED floodlights

Compact floodlight „HUlight10pro“



LED 10W
 170 x 121 x 43 mm
900 Lm
 Lifetime 30000 h
 Akku Li-Ion 4400 mAh 3.7V
 100-240V AC / 12-24V DC
 IP54
 USB
 3h
 CRI 90
 50% / 100%

- Integrated Li-Ion 3.7V / 4.4Ah battery
- **10 watt LED**
- High-quality and solid housing made of diecast aluminium, with plastic edge protector
- For use inside and out, splashproof according to IP54
- Extremely bright illumination, 6500K colour temperature
- 900 Lm luminosity
- Colour rendering 90 CRI (Colour Rendering Index)
- Variable light output, 50% | 100%
- Operating time:
 - Approx. 3 hours with 100% light output
 - Approx. 6 hours with 50% light output
- Approx. 4.75 hours charging time using power unit supplied
- Can be used to charge external devices via USB (power bank function)
- Charger: 100 - 240 V AC plug-in power supply (5 V/1A DC)
- 12V KFZ charging cable
- Adjustable stand

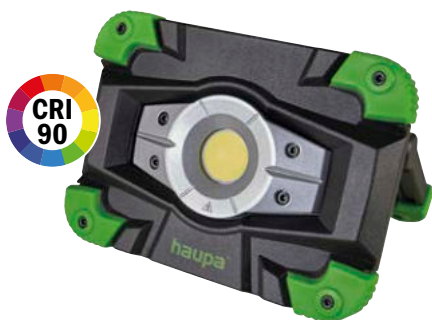

Art. no.	Watt	size	kg	PU
130344 *	10	170 x 121 x 43 mm	0,850	1

Compact floodlight „HUlight20pro“



LED 20W
 185 x 135 x 43 mm
1800 Lm
 Lifetime 30000 h
 Akku Li-Ion 4400 mAh 7.4V
 100-240V AC / 12-24V DC
 IP54
 USB
 3h
 CRI 90
 50% / 100%

- Integrated Li-Ion 7.4V / 4.4Ah battery
- **20 watt LED**
- High-quality and solid housing made of diecast aluminium, with plastic edge protector
- For use inside and out, splashproof according to IP54
- Extremely bright illumination, 6500K colour temperature
- 1800 Lm luminosity
- Colour rendering 90 CRI (Colour Rendering Index)
- Variable light output, 50% | 100%
- Operating time:
 - Approx. 3 hours with 100% light output
 - Approx. 6 hours with 50% light output
- 5 hours charging time using power unit supplied
- Can be used to charge external devices via USB (power bank function)
- Charger: 100 - 240 V AC plug-in power supply (12 V/1A DC)
- 12V KFZ charging cable
- Adjustable stand



Art. no.	Watt	size	kg	PU
130346 *	20	185 x 135 x 43 mm	1,100	1



HUlightpro
Crashtest



Compact LED floodlights

NEW

Compact floodlight „HUPlight30pro“



LED 30W	185 x 135 x 43 mm
2500 Lm	Lifetime 30000 h
Akku Li-Ion 5200 mAh 7.4V	100-240V AC / 12-24V DC
IP54	USB
3h	
CRI 90	50% / 100%

- Integrated Li-Ion 7.4V / 5.2Ah battery
- **30 watt LED**
- High-quality and solid housing made of diecast aluminium, with plastic edge protector
- For use inside and out, splashproof according to IP54
- Extremely bright illumination, 6500K colour temperature
- 2500 Lm luminosity
- Colour rendering 90 CRI (Colour Rendering Index)
- Variable light output, 50% | 100%
- Operating time:
 - Approx. 3 hours with 100% light output
 - Approx. 6 hours with 50% light output
- 5 hours charging time using power unit supplied
- Can be used to charge external devices via USB (power bank function)
- Charger: 100 – 240 V AC plug-in power supply (12 V/1A DC)
- 12V KFZ charging cable
- Adjustable stand



Art. no.	Watt	size	kg	PU
130352 *	30	185 x 135 x 43 mm	1,500	1

Magnetic lamp holder



- Holder for affixing working lamps
- Suitable for Item Nos. 130344, 130346, 130352
- extra strong magnet for flexible mounting



Art. no.	size	kg	PU
130343	85 x 85 x 40 mm	0,180	1

haupa®

...convincing solutions

Compact LED floodlights



Domed luminaire „HUPlight50combi“



- LED 50W
- 4000 Lm
- Li-Ion 6600 mAh 7.4V
- 220-240V 50/60 Hz
- 6500K
- 2h LED
- 5m
- CRI 90
- 360°
- Lifetime 30000 h
- IP54
- 2x 20A sockets

- integrated Li-Ion 7.4 V / 6.6 Ah battery
- **50 watt LED**
- extremely resistant housing made of highly impact-resistant plastic
- for indoor and outdoor use, protected against splashing water according to IP54
- Extremely bright illumination, colour temperature 6500 K
- Brightness 4000 Lm
- Colour rendering 90 CRI
- Variable light output, 50% | 100%
- Operating time:
 - Approx. 2 hours with 100% light output
 - Approx. 4 hours with 50% light output
- Charging time approx 2.5 hours
- 2x earthed sockets: 220 – 240 V~AC | Max: 3000 W
- Charging/power source of external / other devices
- Cable: 5 Metre H07RN-F 3G1.5mm²
- Hook for mounting and hanging up
- Carrying handle
- Dimensions: Ø 280 x 260 mm

ENERGY

HAUPA
130360

A
B
C
D
E
F
G

50 kWh/1000h



Art. no.	Watt	size	kg	PU
130360 *	50	280 x 260 mm	2,240	1

Stand for „HUPlight50combi“



- Dimensions: 115 x 115 x 300 cm
- Adjustable height maximum 3 m
- Weight: ca. 3,5 kg

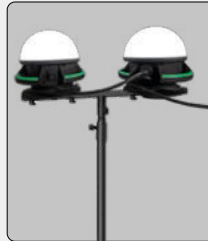

Art. no.	size	kg	PU
130361	1150 x 1150 x 3000 mm	3,500	1



LED light strip



LED light strip 'HUPlightStripe15'

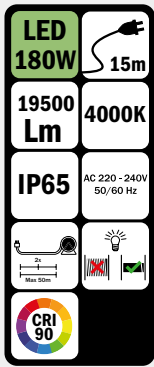

- Operating voltage: AC 220 - 240 V 50/60 Hz
- Connected load: 180 W
- Colour: warm white 4000 K
- 180 LEDs per metre
- Total length 15 m + connecting cable 2,5 m
- Can be extended up to 50 metres using plug or screw connections
- 120° beam angle
- Colour rendering index CRI > 90
- Brightness (Lumen) 19500 Lm
- Safety class 2
- Also for use outdoors IP65
- Dimensions light tube: W 16 mm x H 8 mm
- Dimensions drum: W 286 mm x D 210 mm x H 338 mm

Ideal for illuminating building sites, in particular building shells! Using e.g. cable ties, the LED light strip can be simply hung from the ceiling to illuminate the entire work area evenly. Durable and break-proof, can be used without a cumbersome tripod. Can be stowed in a small and compact manner like a cable drum.

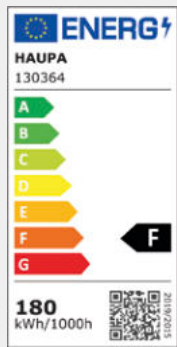

Art. no.	Watt	size	kg	PU
130364	180	16 x 8 x 15000 mm	4,400	1



LED light strip 'HUPlightStripe25'

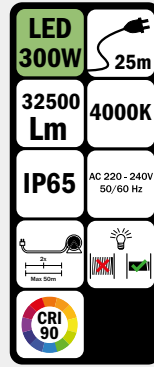

- Operating voltage: AC 220 - 240 V 50/60 Hz
- Connected load: 300 W
- Colour: warm white 4000 K
- 180 LEDs per metre
- Total length 25 m + connecting cable 2,5 m
- Can be extended up to 50 metres using plug or screw connections
- 120° beam angle
- Colour rendering index CRI > 90
- Brightness (Lumen) 32500 Lm
- Safety class 2
- Also for use outdoors IP65
- Dimensions light tube: W 16 mm x H 8 mm
- Dimensions drum: W 317 mm x D 250 mm x H 385 mm

Ideal for illuminating building sites, in particular building shells! Using e.g. cable ties, the LED light strip can be simply hung from the ceiling to illuminate the entire work area evenly. Durable and break-proof, can be used without a cumbersome tripod. Can be stowed in a small and compact manner like a cable drum.

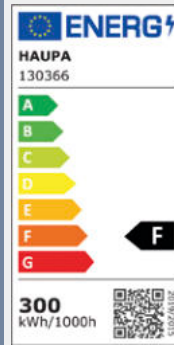

Art. no.	Watt	size	kg	PU
130366	300	16 x 8 x 25000 mm	6,500	1

haupa[®]

...convincing solutions

Measuring tools



Measuring tools

Folding rules

with spring joint, mm-graduations on both sides



Art. no.	TL	type	width	kg	PU
240002 *	2 m	wood	16	0,022	1
240005	2 m	fibre glass	16	0,138	1

Measuring tapes

with spring steel tapes, case: plastic, with automatic return motion and locking key, tape with stove-enamel finished



Art. no.	TL	width	kg	PU
240011	3 m	13	0,104	1
240012 *	5 m	16	0,179	1

Measuring tapes with double scale

with spring steel tapes, case: plastic, with automatic return motion and locking key, tape with stove-enamel finished. Double Scale (cm/inch).



Art. no.	TL	width	kg	PU
240013	5 m	16	0,179	1

Measuring tapes

in metal case, with woven rayon tape, strengthened against stretching by 8 bronze wires woven into tape, scale graduations both sides: metres and centimetres



Art. no.	TL	width	kg	PU
240018	20 m	16	0,432	1
240020	25 m	16	0,544	1
240022	30 m	16	0,586	1
240024	50 m	16	0,857	1

Aluminium spirit levels

bubble level made of acrylic glass, accuracy of measurement: 0,043° = 0,75 mm/m. **Fall arrest on the flanks.**



Art. no.	TL	Spirit level	kg	PU
240041	300	2	0,168	1
240042 *	400	2	0,198	1
240044	600	2	0,282	1
240046	800	2	0,406	1
240048	1000	2	0,534	1

Electrician's safety levels

nonconducting plastic material, with 2 tubes horizontal and vertical



Art. no.	TL	Spirit level	kg	PU
240057	400	2	0,188	1
240058	600	2	0,274	1

Cabinet levels

Torped type, nonconducting plastic material, with 3 tubes horizontal, vertical and 45°



Art. no.	TL	Spirit level	kg	PU
240059 *	200	3	0,078	1

Acrylic „HUPmini“ spirit level

Made of perspex, with 2 levels (horizontal and vertical), with 2 measurement scales (0 - 10 cm and 0 - 5 cm). Dimensions: 100 x 50 x 15 mm



Art. no.	TL	Spirit level	kg	PU
240061	100	2	0,085	1

Measuring tools

Precision pocket vernier calipers „Stainless“

manufactured from stainless steel, completely hardened, with measuring nibs, depth gauge and thread tables, in plastic wallet, 1/20 mm or 1/128", size 150 mm



Art. no.	TL		kg	PU
240071	232	0 - 150	0,157	1

Precision pocket vernier calipers „digital“

manufactured from stainless steel, completely hardened, with measuring nibs, depth gauge and thread tables, in plastic box with sight window, 1/20 mm or 1/128", size 150 mm



Art. no.	TL		kg	PU
240073	235	0 - 150	0,150	1

Engineers' squares

manufactured from steel, bright



Art. no.	TL	width	kg	PU
240132	150x100	20	0,181	1
240134	200x130	20	0,237	1
240136	250x160	25	0,378	1
240138	300x180	25	0,445	1

Engineers' squares

manufactured from steel, bright



Art. no.	TL	width	kg	PU
240152	150x100	20	0,170	1
240154	200x130	20	0,340	1
240156	250x160	25	0,511	1
240158	300x180	25	0,440	1
240160	400x230	30	0,783	1

Steel point scribers

knurled handle, replaceable screw-out hardened points, handle with one straight and one bent point (90°)



Art. no.	TL	kg	PU
240234	250	0,046	1

Carpenters' pencils

12 items per packaging unit



Art. no.	TL	kg	PU
150090	150	0,007	1

Deep hole marker

Marker and writing implement with a refillable solid lead, suitable for all surfaces (including dusty, rough, damp or oily surfaces) cap in a bright signalling colour with integrated sharpener. Also suitable for dark surfaces.



Art. no.	kg	PU
150025	0,291	1
150027	spare lead 10 pc	0,291 1

Marking chalk

12 items per packaging unit

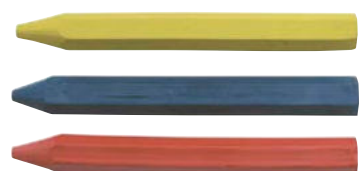

Art. no.	colour	set	kg	PU
150015 B *	blue	12-pieces	0,017	1
150015 G	yellow	12-pieces	0,017	1
150015 R	red	12-pieces	0,016	1

Holder for marking chalk

suitable for marking chalk art. 150015

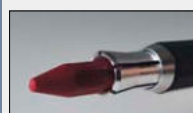

Art. no.	kg	PU
150015/1	0,036	1

haupa[®]

...convincing solutions

Measuring tools

Chalk line roller Squid, 15 m

Chalk line roller made from cast magnesium with push system: Pressure on the axle does not turn the crank; hardened hook with curved spike, integrated storage for the hook, Art. no. 150023: fast-retraction transmission 5:1



Art. no.	size		kg	PU
150019 *	15 m	Squid	0,291	1

Chalk

in plastic bottles, 250 g



Art. no.	colour		kg	PU
140510	red		0,284	1
140520 *	blue		0,276	1
140530	yellow		0,279	1



Maintenance / Workshop equipment



Hand brush „Prestige“ short

- Soft Elaston PET bristles
- Unvarnished wooden body
- 29 cm
- Handle with hole for hanging up



Art. no.	TL	kg	PU
393000 *	290	0,250	1

Hand brush „Prestige“ short

- Soft coconut bristles
- Unvarnished wooden body
- 29 cm
- Handle with hole for hanging up



Art. no.	TL	kg	PU
393038	290	0,180	1

Hand brush „Prestige“ long

- Soft Elaston PET bristles
- Unvarnished wooden body
- 43 cm
- Handle with hole for hanging up



Art. no.	TL	kg	PU
393002	430	0,280	1

Hand brush „Prestige“ long

- Soft coconut bristles
- Unvarnished wooden body
- 43 cm
- Handle with hole for hanging up



Art. no.	TL	kg	PU
393040	430	0,180	1

Metal dustpan with wooden handle

- Made from metal
- Painted black
- Wooden handle with hole for hanging up
- Robust version
- 450 x 230 mm



Art. no.	TL	width	kg	PU
393006 *	450	230	0,400	1

Street broom

- Elaston
- 40 cm
- 6/15 rows



Art. no.	TL	kg	PU
393008	400	0,300	1

Broom, for rough dirt

- Elaston
- 40 cm
- For coarse dirt
- Made from wooden corbel
- With hole for handle



Art. no.	TL	kg	PU
393012	400	0,300	1

Broom, for rough dirt

- Soft coconut bristles
- 40 cm / 60 cm
- For coarse dirt
- Made from wooden corbel
- With hole for handle



Art. no.	TL	kg	PU
393034	400	0,269	1
393036	600	0,269	1

Broom, for smooth ground

- 40 cm
- For smooth floors and fine dirt
- Made from wooden corbel
- With hole for handle



Art. no.	TL	kg	PU
393010	400	0,300	1

Broomstick

- Sanded cleanly
- Rounded head
- 1400 mm



Art. no.	TL	kg	PU
393004	1400	0,250	1

Bucket

- Made from plastic
- 12 l / 20 l
- With carry handle



Art. no.	Liter	colour	kg	PU
300102	12	black	0,450	1
300115	20	black	0,600	1

Textile tape

Particularly strong adhesive, UV-resistant.

- 50 m



Art. no.	length/m	width	colour	kg	PU
393016	50	50	grey	0,400	1

Tarpaulin premium

Protects from dust and damp, for indoor use.

- 12 my
- 4 x 12,5 m



Art. no.	TL	width	kg	PU
393026	12500	4000	0,250	1

Tarpaulin, strong

Effective protection from dirt whatever the job, for indoor use.

- 30 my
- 4 x 5 m



Art. no.	TL	width	kg	PU
393022	5000	4000	0,200	1

Tarpaulin, strong

Effective protection from dirt whatever the job, for indoor use.

- 30 my
- 4 x 12,5 m



Art. no.	TL	width	kg	PU
393024	12500	4000	0,500	1

Dust protection door, multi-fleece

Protects from dust and dirt, approximately 120 x 220 cm, zip length approximately 215 cm.



Art. no.	TL	width	kg	PU
393032	2200	1200	0,350	1

Builders waste sack

- LDPE
- Roll containing 5 sacks
- 75 l
- 100 my
- 575 x 1000 mm



Art. no.	TL	width	kg	PU
393018	1000	575	0,020	1

Waste sack, extra

- LDPE
- Roll containing 10 sacks
- 120 l
- 50 my
- 700 x 1100 mm



Art. no.	TL	width	kg	PU
393020 *	1100	700	0,020	1

Construction foil „Profi“

Optimum protection for all jobs indoors and for all outdoor situations.

- 3 x 10 m
- 200g/m²



Art. no.	TL	width	kg	PU
393030	10000	3000	4,500	1

Multi-fleece

Extremely absorbent, anti-slip thanks to PE anti-slip sheet, prevents the ingress of paint or damp, for all DIY, renovation, construction and painting work. Easy to lay, can be reused multiple times, dirt on clothes and shoes is not transported further.

- 1 x 10 m



Art. no.	TL	width	kg	PU
393028	10000	1000	1,500	1

Warning sign, plastic "Caution, Wet floor", yellow

Lettering on both sides, durable and washable, with warning note in text and symbol format

Print: Caution, Wet floor
Colour: Yellow
Material: Plastic
Dimensions (WxH): 30.5 x 62 cm

Only for German and English speaking countries.



Art. no.	Dimensions (WxH)	kg	PU
300117	30,5 x 62 cm	3,850	1

Wire brushes



Art. no.	TL	kg	PU
150002	300	0,131	1

Water brushes

real bristles, vulcanized, textile bound, bristles-Ø 24 mm, length of bristle 48 mm



Art. no.	width	kg	PU
150004	24	0,036	1

Plaster cups

soft rubber



Art. no.	Ø	depth	kg	PU
150006 *	125	90	0,105	1

Plaster pan

Made from steel sheet, hot-dip galvanised, with polished wooden handle and hanging hook

- Diameter: 160 mm | 90 mm, (180 mm | 100 mm)
- Height: 40 mm (60 mm)
- Length including wooden handle 295 mm (325 mm)



Art. no.	Ø	depth	kg	PU
150008	160	40	0,341	1
150010	180	50	0,380	1

Paint scrapers

steel, polished blade, with oval wooden handle



Art. no.	TL	width	kg	PU
150024	185	40	0,043	1
150026 *	205	50	0,051	1
150028	205	60	0,047	1

Trowel

- High-quality stainless steel, non-corrosive
- With red painted handle
- 3 point rib welding
- German beech wood
- Furled handle collar
- For improved hold
- Controlled top quality



Art. no.	TL	kg	PU
150012	160	0,341	1
150029	180	0,341	1

Trowel „Profi“

- Trowel blade and handle forged from a single piece
- Guaranteed no welding
- Blade hardened
- Conically ground



Art. no.	TL	kg	PU
150033	160	0,341	1
150039	180	0,341	1



Set workshop supplies in a construction bucket

Content:

- Sturdy, weather-resistant plastic bucket with a metal handle, 12 l
- PU cut-protection gloves Level 5, grey, size 10
- Hand brush, short, 29 cm
- Metal dustpan with a wooden handle
- Rubble sack 75 l, 575 x 1000 mm, 5 sacks
- Rubbish sack extra 120 l, 700 x 1100 mm, 10 sacks



Art. no	set	kg	PU
393107	6-pieces	0,700	1

INFO

Lashing belts

Industrial quality

Both for experts and private persons: Load safety is a very important topic.

In case a shipping belt is not or wrong installed and the goods slip or fall down the consequences are grave. The least risks are that the goods or vehicles get damaged. Even small unfasten things can turn into bullets and jeopardise your life or the life of other persons in case of emergency braking. For this reason police and trade association regularly withdraw vehicles with insufficient safety load from service.

For this reason we would like to introduce you to some simple declared basic principles for the correct load safety. It does not matter if you carry a bike or a new refrigerator, if you pack tools and construction materials into your van daily or if you load complete trucks.

Single lashing belts are used for the strapping of the load. They do not need any connecting elements. If you want to safe heavy objects from turning over or falling down you should use single lashing belts. The clamping elements enable high traction forces without muscle power. Please choose the belt depending on the desired traction and depending on where you put on the belt.

Two-piece lashing belts are easy to be handled and you can fix them quickly. Nowadays they are very important for the load safety. They assume that belts can be hooked, e. g. loops, rails etc. are available. You save time because the belt does not have to be leaded around the goods.

Lashing belt 400 daN, one-piece

Permitted tensile force 400 daN in a straight line, one-piece. Manufactured according to DIN EN 12195-2.

- 800 daN when wrapped
- Colour green
- Belt width 25 mm
- Belt length 8 m
- With mini ratchet



Art. no.	TL	width	daN	kg	PU
393150	8000	25	400	0,350	1

Lashing belts

Lashing belt 400 daN, two-piece with hook

Permitted tensile force 400 daN in a straight line, two-piece with hook. Manufactured according to DIN EN 12195-2.

- 800 daN when wrapped
- Colour green
- Belt width 25 mm
- Belt length 8 m
- With mini ratchet



Art. no.	TL	width	daN	kg	PU
393152	8000	25	400	0,450	1

Lashing belt 1000 daN, one-piece

Permitted tensile force 1000 daN in a straight line, one-piece. Manufactured according to DIN EN 12195-2.

- 2000 daN when wrapped
- Colour green
- Belt width 35 mm
- Belt length 8 m
- with pressure ratchet

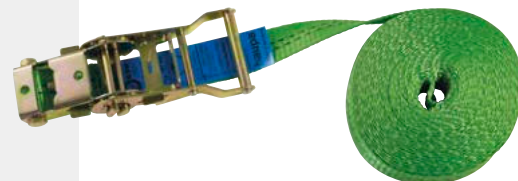

Art. no.	TL	width	daN	kg	PU
393154	8000	35	1000	1,000	1

Lashing belt 1000 daN, two-piece with hook

Permitted tensile force 1000 daN in a straight line, two-piece with hook. Manufactured according to DIN EN 12195-2.

- 2000 daN when wrapped
- Colour green
- Belt width 35 mm
- Belt length 8 m
- with pressure ratchet

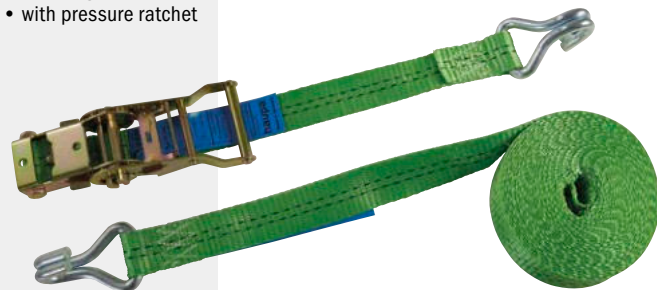

Art. no.	TL	width	daN	kg	PU
393156	8000	35	1000	1,400	1

INFO

Classification of ladders

Industrial quality

Our ladders are designed and tested according to the EN 131 Standard.

They are suitable for both private and commercial use. Endurance tests of, for example, 4,000 telescopic slides and other extreme loads, such as the alternating load of the uppermost step of 50,000 cycles, are only a fraction of the requirements that are fulfilled in full and beyond.

The high quality standards make our ladders the perfect companion for the professional.



Aluminium telescoping stepladder

Ideal for transport in the smallest of spaces, can be used as stepladders and single ladders.



Properties:

- Cross supports for a secure positioning
- with carrying handle
- The 2-stage leg support can be pulled out or remain in the ladder.
- bevelled, non-slip rubber feet for the right angle of attack
- sliding brake for a safe retraction



Art. no.	Length	Rungs	Retracted	Width	kg	PU
392804	2,3 m	6+2	0,74 m	0,69 m	14,5 kg	1

haupa[®]

...convincing solutions

Aluminium telescoping stepladder

Ideal for transport in the smallest of spaces, can be used as stepladders and single ladders.

Properties:

- Cross supports for a secure positioning
- with carrying handle
- The 2-stage leg support can be pulled out or remain in the ladder.
- bevelled, non-slip rubber feet for the right angle of attack
- sliding brake for a safe retraction

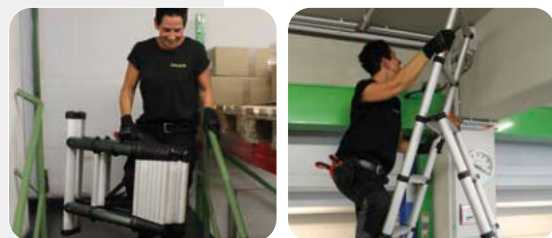

Art. no.	Length	Rungs	Retracted	Width	kg	PU
392806	3,0 m	8+2	0,79 m	0,76 m	20,0 kg	1

Aluminium telescoping single-ladder

Ideal for transport.

Properties:

- variable adjustment of the height by means of lasered height indicators on the steps
- complex, stable cross support (for article 392802)
- more safety and comfort thanks to step extensions and anti-slip grooves
- comfortable pressure closer, easy operation even with wet hands
- sliding brake for a safe retraction
- Rubber caps on feet and upper end

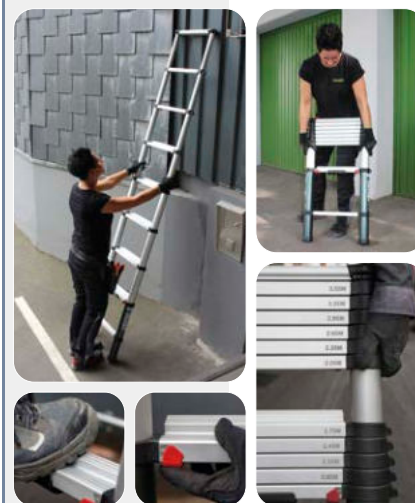

Art. no.	Length	Rungs	Retracted	Width	kg	PU
392800	2,6 m	9	0,72 m	0,49 m	8,10 kg	1



Aluminium telescoping single-ladder

Ideal for transport.

Properties:

- variable adjustment of the height by means of lasered height indicators on the steps
- complex, stable cross support (for article 392802)
- more safety and comfort thanks to step extensions and anti-slip grooves
- comfortable pressure closer, easy operation even with wet hands
- sliding brake for a safe retraction
- Rubber caps on feet and upper end



Art. no.	Length	Rungs	Retracted	Width	kg	PU
392802	3,8 m	13	0,86 m	0,88 m	15,0 kg	1

haupa[®]

...convincing solutions

Chisels, Hammers





Flat chisels to DIN 6453 A, flat oval shank

chrome vanadium air hardenend steel, painted black, chrome-plated tip



Art. no.	TL	CW	mat/S	mat/S1	kg	PU
180008	200	28	23	13	0,392	1
180010	250	28	23	13	0,490	1
180012	300	32	26	13	0,606	1

Stone chisels, flat oval shank

chrome vanadium air hardenend steel, painted black, chrome-plated tip



Art. no.	TL	CW	mat/S	mat/S1	kg	PU
180042	250	28	20	12	0,394	1
180044 *	300	32	23	13	0,584	1

Stone chisels, octagonal shank

chrome vanadium air hardenend steel, painted black, chrome-plated tip



Art. no.	TL	CW	mat/S	mat/S1	kg	PU
180062	250	28	16	16	0,387	1
180064	300	30	18	18	0,595	1

Jointing chisel

chrome vanadium air hardenend steel, painted black, chrome-plated tip, for light works, the wide and flat cutting edge allows a quick working and avoid a breaking out of the wall



Art. no.	TL	CW	mat/S	mat/S1	kg	PU
180076 *	250	26	26	7	0,302	1

Stone chisels, octagonal shank

chrome vanadium air hardenend steel, painted black, chrome-plated tip



Art. no.	TL	CW	mat/S	mat/S1	kg	PU
180082	250	14	14	14	0,358	1
180084	300	16	16	16	0,573	1

Electricians' chisels

chrome vanadium air hardenend steel, painted black, chrome-plated tip



Art. no.	TL	CW	mat/S	mat/S1	kg	PU
180090	200	8	6	6	0,052	1
180092 *	250	10	8	8	0,119	1
180094	250	12	8	8	0,121	1

Centre punch to DIN 7250

octagonal shank, chrome vanadium air hardenend steel, painted black, chrome-plated tip



Art. no.	TL	Ø	kg	PU
180120	120	12	0,091	1

Firmer chisels DIN 5139

with bevelled edges and polished wooden handle and cutting edge protector



Art. no.	TL	CW	BL	kg	PU
180464	280	14	150	0,120	1
180466	280	16	150	0,132	1
180468	280	18	150	0,161	1
180470	280	20	150	0,170	1
180474	280	24	150	0,193	1

Rubber hand guard

total length 140 mm, max. Ø 90 mm, for chisels flat oval shank



Art. no.	size	mat/S	mat/S1	kg	PU
180110	3	23	13	0,125	1

Pin punch set

painted black, chrome-plated tip, in folding metal case
Contents: Ø 2 - 3 - 4 - 5 - 6 - 8 mm



Art. no.	set	kg	PU
180170	6-pieces	0,502	1

Household hatchet

varnished and polished cutting edge, DIN 5131



Art. no.	kg	PU
180173	0,600	1

Claw hammer

American model, 16 Oz, wooden handle



Art. no.	size	kg	PU
180321	16	0,621	1



Hammers

Claw hammer

American model, 16 Oz, fibreglass handle



Art. no.	size	kg	PU
180323	16	0,748	1

Engineers' hammer DIN 1041

with polished hickory handle, with steel handle protection



Art. no.	HW	kg	PU
180182	200	0,238	1
180184 *	300	0,370	1
180186	400	0,470	1
180188	500	0,622	1

Engineers' hammer DIN 1041

with steel pipe handle and rubber grip



Art. no.	HW	kg	PU
180200	300	0,552	1
180202	500	0,740	1

Engineers' hammer DIN 1041

with red ultramid handle, low vibration



Art. no.	HW	kg	PU
180232	300	0,410	1

Engineers' hammer

English pattern, ball pin



Art. no.	HW	kg	PU
180274	340	0,416	1
180276	450	0,485	1

Sledge hammer to DIN 6475

with steel pipe handle and rubber grip



Art. no.	HW	kg	PU
180290	1000	1,210	1
180292	1250	1,504	1

Sledge hammer to DIN 6475

with polished, fluted hickory handle, with steel handle protection



Art. no.	HW	TL	kg	PU
180300 *	1000	260	1,093	1
180302	1250	260	1,375	1

Soft-head hammer

with replaceable cellidor striking faces and ash handle



Art. no.	Ø	kg	PU
180334	32	0,328	1
180346	replacement heads	0,460	1

haupa®

...convincing solutions

Steel stamps

Steel stamp, figures (0 - 9) DIN 1451



Art. no.	size	set	kg	PU
130200	3	0-9	0,160	1
130201	4	0-9	0,243	1
130202	5	0-9	0,300	1
130203	6	0-9	0,450	1
130204	8	0-9	0,650	1
130206	10	0-9	0,800	1

Steel stamp, letters (A - Z), DIN 1451



Art. no.	size	set	kg	PU
130208	3	A-Z	0,461	1
130209	4	A-Z	0,650	1
130210	5	A-Z	0,850	1
130211	6	A-Z	1,200	1
130212	8	A-Z	1,950	1
130214	10	A-Z	2,479	1

Files

Contact files

Set: 6 files in plastic wallet



Art. no.	TL	set	kg	PU
190126	130	6-pieces	0,078	1

File assortments

Set: 5 files in plastic wallet, files with plastic handle

Form:
 round
 square
 flat
 half round
 triangular



Art. no.	TL	set	kg	PU
190130	100	bastard cut 1	0,784	1
190132 *	200	smooth cut 3	0,799	1

Knives



Cable stripping knives

Cable stripping or lead tube knives

with wooden handle



Art. no.	BL	kg	PU
200008	40	0,047	1

Cable stripping knives

solid handle, shock-proof synthetic, blade with straight and rounded scraper



Art. no.	BL	form	kg	PU
200010	60	straight	0,073	1

Cable stripping knives

with black plastic scales, stainless blade with scraper



Art. no.	BL	form	kg	PU
200011	60	straight	0,082	1

Cable stripping knives

with wooden scales, blade with scraper



Art. no.	BL	form	kg	PU
200012	60	straight	0,079	1

Cable stripping knives

with wooden scales, blade and reamer



Art. no.	BL	form	kg	PU
200014	60	straight	0,078	1

Cable stripping knives

with wooden scales, blade, reamer and screwdriver, including scraper



Art. no.	BL	form	kg	PU
200016	60	straight	0,089	1

Cable stripping knives

with plastic scales, 2 blades, reamer and screwdriver, including scraper



Art. no.	BL	form	kg	PU
200018	60	straight	0,092	1

Utility knives

Utility metal knives

Cutting of plastic, wallpaper, cardboards, leather, plywood, carpets, with automatic blades locking, reserve blade in the handle



Art. no.	BL	form	kg	PU
200025	9	straight	0,072	1

Snap blades

10-pieces, suitable for article 200025

10 x



Art. no.	BL	form	set	kg	PU
200025/KL	9	straight	10-pieces	0,050	1

Utility metal knives

Cutting of plastic, wallpaper, cardboards, leather, plywood, carpets, with automatic blades locking, reserve blade in the handle



Art. no.	BL	form	kg	PU
200027 *	18	straight	0,150	1

Safety cutter knife

for cutting plastics, wallpaper, cardboard, leather, carpets, with automatic blade lock, blade guide made of metal, soft grip, 1x blade 18 mm included, with automatic blade retraction to prevent cutting injuries



Art. no.	BL	form	kg	PU
200209	18	straight	0,098	1

Utility knives „EXTRA“ with spare blades

Cutting of plastic, wallpaper, cardboards, leather, plywood, carpets, with automatic blades locking, softgrip, 2 reserve blades in the handle



Art. no.	BL	form	kg	PU
200051	18	straight	0,022	1

Snap blades

10-pieces, suitable for article 200027 + 200051

10 x



Art. no.	BL	form	set	kg	PU
200032	18	straight	10-pieces	0,054	1

HAUPA Black Blades

Cutter blades, 10-part, suitable for Art. 200209

- **very sharp blade** for precise cuts
- fits all conventional cutter knives
- dual edge for maximum sharpness
- maximum lifespan thanks to flame hardening process
- ideal for various materials
- blade is coated black
- delivered in a dispenser
- 8 segments
- 100 x 18 x 0.5 mm

NEW



PREMIUM

10 x



Art. no.	BL	form	set	kg	PU
200006	18	straight	10-pieces	0,080	1

„Safety“ safety knife

Robust construction made from zinc die casting, large cutting depth, slider on the top, with automatic blade retraction to protect against cutting injuries, with a trapezoidal blade, for cutting plastics, wallpaper, card, leather, plywood and carpet.



PREMIUM

Art. no.	BL	TL	form	kg	PU
200021	22	148	straight	0,105	1

haupa®

...convincing solutions

Utility knives

Utility knife

Utility knife with holder, with a trapezoidal blade, tool-free blade change, with blade depot, ergonomic design with softgrip



Art. no.	BL	form	kg	PU
200059	20	straight	0,111	12

Loose knife, hooked blade

10-pieces, suitable for article 200021 + 200059

10x



Art. no.	BL	form	set	kg	PU
200028	20	hooked	10-pieces	0,004	1

Loose knife, trapezoidal blade

10-pieces, suitable for article 200021 + 200059

10x

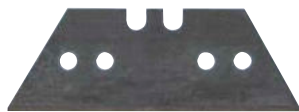

Art. no.	BL	form	set	kg	PU
200030	20	trapezoidal	10-pieces	0,005	1

Tin snips, tube cutters

Hole-cutting tin snips

with polished blade, carbon steel, figure cuts (large radii)



Art. no.	TL	kg	PU
200140	250	0,523	1

Small tube cutter

with 1 cutting wheel and dual roller guides
Ø 1/8" - 5/8"



Art. no.	Ø	kg	PU
200190	3-16	0,107	1
200192	loose spare wheels	0,025	1

Tube cutter

with 1 cutting wheel and dual roller guides, retractable burr remover,
Ø 1/8" - 1 3/8"



Art. no.	Ø	kg	PU
200194	3-35	0,401	1
200196	loose spare wheels	0,006	1

Saws, saw blades

Junior hacksaw

strong frame, nickel-plated



Art. no.	type	Sbl.	kg	PU
200280	metal	150	0,149	1

Junior hacksaw DIN 6473 C

hacksaw blade for metal



Art. no.	type	Sbl.	kg	PU
200284	metal	150	0,069	1

Junior hacksaw

heavy type, with pistol type handle and hacksaw blade for metal, form A



Art. no.	type	Sbl.	kg	PU
200285	metal	150	0,164	1

Junior hacksaw

heavy type, with pistol type handle and hacksaw blade for metal, form A



Art. no.	type	Sbl.	TL	kg	PU
200287	metal	150	260	0,164	1

Hand saw „PUK“

with hacksaws blade for metal, with fixed, varnished wooden handle



Art. no.	type	Sbl.	kg	PU
200290 *	metal	150	0,100	1

Hand saw „PUK“

with adjustable, varnished wooden handle, in plastic bag



Art. no.	type	Sbl.	kg	PU
200292	metal	150	0,119	1

Hacksaw blades „PUK“

acc. to DIN 6494C, for Art. No. 200292, 200280, 200290, 200284, 200285, 200287, 110558, 12 pieces per packaging unit

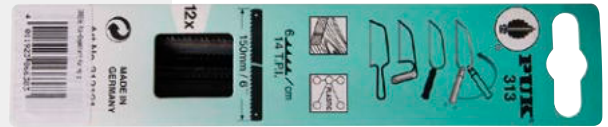

Art. no.	type	type	Sbl.	kg	PU
200286	wood	plastic	150	0,036	1

Hacksaw blades „PUK“

acc. to DIN 6494C, for Art. No. 200292, 200280, 200290, 200284, 200285, 200287, 110558, 12 pieces per packaging unit



Art. no.	type	type	Sbl.	kg	PU
200288	metal	universal	150	0,036	1

Hacksaw frame

steel pipe with flat oval section, bright chrome-plated, tension bolt made from steel, form A



Art. no.	type	Sbl.	kg	PU
200304 *	metal	300	0,408	1

Hacksaw blades to DIN 6494

type A, single sided blade HSS-Bi-metal



Art. no.	type	Sbl.	kg	PU
200310	metal	300	0,016	1

haupa®

...convincing solutions

Drilling tools



Twist drills, ground

Twist drills DIN 338/HSS type N

point angle 118°, spiral angle 25 - 35°, Ø-tolerance h 8, of HSS, for drilling of steel, steel-casting alloyed and unalloyed up to approx. 900 N/mm² strength grey- and tempered casting, sinter iron, newsilver, graphit, alu-alloy, bronze and brass

Packaging unit in blister pack:

0,5 - 3,0 mm; 1 SPU = 3 pieces
3,2 - 6,0 mm; 1 SPU = 2 pieces
6,5 - 13,0 mm; 1 SPU = 1 piece

xxxxxx/CO = Cobalt

Packaging unit in blister pack:

1,0 - 3,0 mm; 1 SPU = 2 pieces
3,2 - 13,0 mm; 1 SPU = 1 piece



Art. no.	Ø	core-hole	SL	TL	VE
230010	0,5		6	22	1
230020	1		12	34	1
230020/CO					1
230030	1,5		18	40	1
230030/CO					1
230032	1,6	M2	20	43	1
230032/CO					1
230040	2		24	49	1
230040/CO					1
230050	2,5	M3	30	57	1
230050/CO					1
230060	3		33	61	1
230060/CO					1
230064	3,2		36	65	1
230064/CO					1
230066	3,3	M4	36	65	1
230066/CO					1
230070	3,5		39	70	1
230070/CO					1
230080	4		43	75	1
230080/CO					1
230084	4,2	M5	43	75	1
230084/CO					1
230090	4,5		47	80	1
230090/CO					1
230100	5	M6	52	86	1
230100/CO					1
230110	5,5		57	93	1
230110/CO					1
230120	6	M7	57	93	1
230120/CO					1
230130	6,5		63	101	1
230130/CO					1
230136	6,8	M8	69	101	1
230136/CO					1
230140	7		69	109	1
230140/CO					1
230160	8		75	117	1
230160/CO					1
230170	8,5	M10	75	117	1
230170/CO					1
230180	9		81	125	1
230180/CO					1
230190	9,5		81	125	1
230190/CO					1
230200	10		87	133	1
230200/CO					1
230204	10,2	M12	87	133	1
230204/CO					1
230210	10,5		87	133	1
230210/CO					1

Art. no.	Ø	core-hole	SL	TL	VE
230220	11		87	133	1
230220/CO					1
230230	11,5		94	142	1
230230/CO					1
230240	12	M14	101	151	1
230240/CO					1
230244	12,5		101	151	1
230244/CO					1
230250	13		101	151	1
230250/CO					1

Twist drills DIN 338/HSS type N

made from high power steel, in plastic pocket

Technical information:

Standard version: Industrial quality, dressed to size from solid material, high true tuning precision, long tool life, cutter separate packet in plastic bags or as a set in a box.

/PB: as beside

/R: workshop quality, wheeled milled

/TIN: as beside, titanium nitride coating



Art. no.	Ø	set	kg	PU
230312	1 - 10	19-pieces	0,312	1
230312/R	1 - 10		0,284	1
230312/TIN	1 - 10		0,345	1
230314	1 - 13	25-pieces	1,270	1
230314/R	1 - 13		1,213	1
230314/TIN	1 - 13		1,290	1

Bulk storage chest for twist drills

HSS, DIN 338, 170 pieces, TYP N, short, ground, bright, with split point, TIN coated.

Contents: 1.0 - 10.0 mm (upstairs in 0.5 mm steps)
up to 8,0 mm 10 pieces/size
> 8,5 mm 5 pieces/size



Art. no.	set	kg	PU
230301/TIN	170-pieces	4,550	1

Drills

Auger bit, type Lewis



Art. no.	TL	Ø	kg	PU
231502	460	6	0,005	1
231508	235	10	0,098	1
231516	235	14	0,005	1
231524	235	18	0,200	1
231526	460	18	0,468	1
231528	235	20	0,005	1
231530	460	20	0,005	1
231532	235	22	0,300	1
231540	235	26	0,005	1
231544	235	28	0,005	1
231546	460	28	0,005	1

Drill type machine bits for wood

made from carbon steel, concentrically ground, with centre point and front cutter



Art. no.	TL	Ø	kg	PU
230616	70	3	0,005	1
230618	80	4	0,008	1
230620	90	5	0,011	1
230622	100	6	0,015	1
230626	120	8	0,031	1
230628	130	9	0,039	1
230630	137	10	0,047	1
230634	150	12	0,075	1
230636	170	13	0,088	1

Flat bits

with flat cutter head, square shank, DIN 6447 A



Art. no.	TL	Ø	shank	kg	PU
230732	150	10	6	0,041	1
230734	150	12	6	0,041	1
230736	150	14	6	0,048	1
230738	150	16	6	0,051	1
230740	150	18	6	0,047	1
230742	150	20	6	0,045	1
230746	150	24	6	0,045	1

Casing drill

With cylindrical clamping shaft, cutting element made of chrome vanadium steel



Art. no.	TL	Ø	kg	PU
231750	400	6	0,100	1
231752	400	8	0,005	1
231754	400	10	0,160	1
231756	400	12	0,200	1
231758	400	13	0,200	1
231760	400	17	0,005	1
231766	400	22	0,200	1

Drills

Masonry drills DIN 8039

carbide tipped, with straight shank, each piece in plastic pocket



Art. no.	TL	Ø	CL	kg	PU
230330	70	3	40	0,003	1
230331	75	3,5	45	0,056	1
230332	80	4	45	0,008	1
230334	85	4,5	50	0,008	1
230338	95	5,5	55	0,012	1
230340	100	6	60	0,018	1
230342	105	6,5	65	0,018	1
230344	110	7	65	0,018	1
230346	120	8	70	0,027	1
230352	140	10	90	0,035	1
230354	150	11	95	0,082	1
230356	160	12	105	0,090	1
230358	170	13	110	0,100	1
230360	180	14	115	0,120	1
230362	190	15	125	0,165	1
230364	190	16	125	0,092	1

Masonry drills DIN 8039

carbide tipped, with straight shank, each piece in plastic pocket



Art. no.	TL	Ø	CL	kg	PU
230370	400	8	300	0,130	1
230372	400	10	300	0,124	1
230376	400	14	300	0,316	1
230378	400	16	300	0,232	1
230380	400	18	300	0,460	1
230382	400	20	300	0,608	1
230400	600	8	500	0,222	1
230402	600	10	500	0,222	1
230404	600	12	500	0,330	1
230406	600	14	500	0,463	1
230408	600	16	500	0,568	1
230410	600	18	500	0,715	1
230412	600	20	500	0,896	1
230414	600	22	500	1,164	1

Masonry drill bit

High-Helix Masonry drill bit, sand blasted, countersink construction, professional quality



Art. no.	TL	Ø	kg	PU
231700	70	3	0,007	1
231702	85	4	0,011	1
231704	95	5	0,017	1
231706	100	6	0,018	1
231708	100	7	0,020	1
231710	120	8	0,027	1
231712	120	9	0,030	1
231714	120	10	0,035	1
231716	150	11	0,090	1
231718	150	12	0,100	1

haupa®

...convincing solutions

SDS hammer drill bits

Top quality: SDS-Plus fast fitting system: 2 lengthwise slots and 2 round slots at the end of the shank. Universal tool fitting for different types of hammer drills according to the SDS-Plus system



Art. no.	TL	Ø	CL	kg	PU
230430	110	5	50	0,037	1
230431	160	5	100	0,042	1
230432	110	5,5	50	0,037	1
230433	160	5,5	100	0,045	1
230434	110	6	50	0,039	1
230436	160	6	100	0,045	1
230438	110	6,5	50	0,038	1
230438/A	160	7	100	0,050	1
230438/B	160	6,5	100	0,047	1
230440	110	7	50	0,041	1
230442	110	8	50	0,046	1
230442/A	160	8	100	0,056	1
230444	210	8	150	0,064	1
230444/A	460	8	400	0,150	1
230448	160	10	100	0,065	1
230450	210	10	150	0,087	1
230450/A	260	10	150	0,118	1
230451	460	10	400	0,192	1
230453	210	12	150	0,107	1
230454	160	12	100	0,097	1
230456	260	12	200	0,159	1
230457	460	12	400	0,263	1
230458	160	13	85	0,111	1
230459	600	12	540	0,286	1
230460	160	14	100	0,087	1
230460/A	260	14	200	0,171	1
230461	460	14	400	0,257	1
230464	210	16	150	0,197	1
230466	460	16	400	0,418	1
230467	600	14	540	0,339	1
230473	600	16	540	0,561	1
230474	210	20	150	0,246	1
230475	460	18	400	0,475	1
230478/1	600	10	540	0,270	1
230395	460	20	400	0,585	1
230396	600	20	540	0,737	1
230397	460	22	400	0,669	1
230398	460	25	400	0,998	1

SDS-Nut-hammer drill sets

Contents: 5, 6, 8 x 110 / 6, 8, 10, 12 x 160



Art. no.	set	kg	PU
230479	7-pieces	0,679	1

SDS hammer drill bits

Workshop quality: SDS-Plus fast fitting system: 2 lengthwise slots and 2 round slots at the end of the shank. Universal tool fitting for different types of hammer drills according to the SDS-Plus system



Art. no.	TL	Ø	CL	kg	PU
230900	110	5	50	0,036	1
230902	160	5	100	0,042	1
230904	110	5,5	50	0,036	1
230906/1	160	5,5	100	0,043	1
230908	110	6	50	0,040	1
230910	160	6	100	0,045	1
230912	110	6,5	50	0,041	1
230914	160	6,5	100	0,045	1
230916	110	7	50	0,040	1
230918	160	7	100	0,045	1
230920	110	8	50	0,045	1
230922	160	8	100	0,055	1
230924	210	8	150	0,067	1
230926	160	10	100	0,068	1
230928	210	10	150	0,095	1
230930/1	260	10	150	0,107	1
230932	450	10	400	0,155	1
230934	600	10	540	0,365	1
230936	260	11	210	0,070	1
230938	160	12	100	0,077	1
230940	210	12	150	0,106	1
230942	310	12	260	0,120	1
230944	460	12	400	0,250	1
230946	600	12	540	0,315	1
230948	160	13	100	0,085	1
230950	160	14	100	0,200	1
230952	260	14	210	0,250	1
230954/1	460	14	400	0,300	1
230956	600	14	540	0,365	1
230958	160	15	100	0,120	1
230960	210	16	150	0,195	1
230962/1	460	16	400	0,346	1
230964	600	16	540	0,418	1
230966	200	18	140	0,180	1
230968	460	18	400	0,395	1
230970	210	20	150	0,221	1
230972	310	20	250	0,383	1
230974	460	20	400	0,503	1
230976	460	22	400	0,583	1
230978	460	25	400	0,753	1

SDS-hammer drill sets

Contents: 5, 6 x 110, 6, 8, 10 x 160



Art. no.	set	kg	PU
230979	5-pieces	0,261	1



Step drills



Combination step drills/HSS

for metric PG rough thread-through-hole and core-hole-drillings, 6 drilling diameters for core-hole with 5 mm step for sheet metal up to max. 6 mm.
Through-hole: 8,5 - 12,5 - 16,5 - 20,5 - 25,5 - 32,5 - 40,5 mm
core-hole: 10,5 (M12) - 14,5 (M16) - 18,5 (M20) - 23,5 (M25) - 30,5 (M32) - 38,5 (M40)



Art. no.	shankt/Ø	min./Ø	max./Ø	kg	PU
231319 *	12	8,5	40,5	0,269	1

Step drills /HSS

Special type for electric assembly, for sheet metal up to max. 4 mm gauge, for metric thread through-hole drilling,
8,5 - 12,5 - 16,5 - 20,5 - 25,5 - 32,5 - 40,5 mm



Art. no.	shankt/Ø	min./Ø	max./Ø	kg	PU
231324	12	8,5	40,5	0,199	1

Step drills /HSS

thickness up to max. 6 mm, for metric core-hole-drilling,
8,5 - 10,5 - 14,5 - 18,5 - 23,5 - 30,5 - 38,5 mm (M10 - M40)



Art. no.	shankt/Ø	min./Ø	max./Ø	kg	PU
231326	12	8,5	38,5	0,208	1



Step drills /HSS

special type for electric assembly, for sheet steel up to 4 mm thickness, for amoured conduit thread sizes



Art. no.	shankt/Ø	min./Ø	max./Ø	kg	PU
231320	12	7	40	0,237	1
231322	10	7	21	0,151	1

Step drills /HSS

for mechanical engineering and tinsmith working, with 2 cutters, metric



Art. no.	shankt/Ø	min./Ø	max./Ø	kg	PU
231336	6	4	12	0,027	1
231338	9	12	20	0,079	1
231340	12	20	30	0,203	1
231342	12	30	40	0,371	1
231350	6	4	12	0,027	1
231352	8	4	20	0,059	1
231354	10	6	30	0,162	1

Step drills assortment/HSS

3 pieces, for mechanical engineering and tinsmith working, with 2 cutters.

Contents:

Ø 4 - 12 mm, Ø 12 - 20 mm, Ø 20 - 30 mm



Art. no.	Ø	set	kg	PU
231327	4 - 30	3-pieces	0,597	1

Rotary guide value for step drills/cone drills

Material	unleg. Baustahl < 700 N/mm ² Mild steel	unleg. Baustahl > 700 N/mm ² Mild steel	leg. Stahl < 1000 N/mm ² Alloy steel	Gußeisen < 250 N/mm ² Cast iron	Gußeisen > 250 N/mm ² Cast iron	Edelstahl rostfrei Stainless steel	CuZn Leg. spröde CuZn alloy brittle	CuZn Leg. zäh CuZn alloy tough	AL Leg. < 11% Si Alloy steel < 11% Si	Thermo- plaste Thermo plastic	Duro- plaste Duro plastic	Holz Wood
Materialstärke Material gauge	6,0 mm	6,0 mm	6,0 mm	6,0 mm	6,0 mm	3,0 mm	6,0 mm	6,0 mm	6,0 mm	6,0 mm	6,0 mm	25,0 mm
Kühlung	Bohrpaste	Bohrpaste	Bohrpaste	Luft	Luft	Bohrpaste	Luft	Bohrpaste	Bohrpaste	H ² O	Luft	Luft
Lubricant	Drilling paste	Drilling paste	Drilling paste	Air	Air	Drilling paste	Air	Air	Drilling paste	H ² O	Air	Air
Vc = m / min	25	20 - 25	20	15	10	5	60	35	30	20	15	> 40
Ø mm	U/min r.p.m	U/min r.p.m	U/min r.p.m	U/min r.p.m	U/min r.p.m	U/min r.p.m	U/min r.p.m	U/min r.p.m	U/min r.p.m	U/min r.p.m	U/min r.p.m	U/min r.p.m
4,0 - 12,0	1900 - 600	1700 - 580	1550 - 520	1190 - 400	800 - 250	400 - 130	4700 - 1550	2750 - 920	2350 - 790	1550 - 520	1190 - 400	3000 - 1000
4,0 - 20,0	1900 - 400	1700 - 350	1550 - 300	1190 - 240	800 - 160	400 - 80	4700 - 950	2750 - 550	2350 - 470	1550 - 300	1190 - 240	3000 - 650
12,0 - 20,0	600 - 400	600 - 350	520 - 300	400 - 240	250 - 160	130 - 80	1550 - 950	920 - 550	790 - 470	520 - 300	400 - 240	1000 - 650
4,0 - 24,0	1900 - 300	1700 - 280	1550 - 250	1190 - 200	800 - 130	400 - 65	4700 - 790	2750 - 460	2350 - 400	1550 - 250	1190 - 200	3000 - 550
6,0 - 30,0	1300 - 250	1200 - 230	1000 - 200	780 - 150	530 - 100	250 - 50	3150 - 630	1850 - 370	1590 - 310	1000 - 200	780 - 150	2100 - 420
20,0 - 30,0	400 - 250	350 - 230	300 - 200	230 - 150	160 - 100	80 - 50	950 - 630	550 - 370	470 - 310	300 - 200	230 - 150	650 - 420
6,0 - 36,0	1300 - 220	1200 - 200	1000 - 170	780 - 130	530 - 90	250 - 45	3150 - 530	1850 - 300	1590 - 260	1000 - 170	780 - 130	2100 - 350
30,0 - 40,0	250 - 200	230 - 180	200 - 150	150 - 120	100 - 80	50 - 40	630 - 470	370 - 280	310 - 240	200 - 150	150 - 120	420 - 310
40,0 - 50,0	200 - 160	180 - 140	150 - 125	120 - 90	80 - 65	40 - 30	470 - 380	280 - 220	240 - 190	150 - 125	120 - 90	310 - 250
50,0 - 60,0	160 - 130	140 - 110	125 - 100	90 - 80	65 - 50	30 - 25	380 - 310	220 - 185	190 - 150	125 - 100	90 - 80	250 - 210

haupa®

...convincing solutions

Cone drills



Cone drills/Aerial drills/HSS

for edgefree drilling of thin material



Art. no.	shankt/Ø	min./Ø	max./Ø	kg	PU
231300	6	3	14	0,027	1
231301	8	6	20	0,055	1
231330	8	6	22,5	0,085	1
231302	10	16	30	0,139	1
231304	12	26	40	0,265	1
231305 *	10	6	30	0,166	1
231306	12	36	50	0,350	1
231307	13	46	60	0,551	1

Set of cone drills/HSS

3 pieces, in metal box.

1 piece each No. 1, 2, 3 (Ø 3 - 30 mm), suitable for NE material, soft steel sheet, similar to St 14 - 37, Nirosta steel sheet A 2, for duro or thermo plastic



Art. no.	Ø	set	kg	PU
231312	3 - 30	3-pieces	0,510	1

Screw punches

Screw punches

matching for cable connection acc. the new Euro-Norm EN 50262, with 3 cutting edges for iron sheet up to 2 mm, steel sheet up to 1,5 mm, stainless-steel sheet up to 1,5 mm thickness



Art. no.		screws	kg	PU
180513	metric	ISO 16 180530	0,101	1
180515	metric	ISO 20 180530	0,115	1
180517	metric	ISO 25 180530	0,154	1
180519	metric	ISO 32 180532	0,320	1
180521	metric	ISO 40 180532	0,950	1
180523	metric	ISO 50 180534	0,636	1
180525	metric	ISO 63 180534	0,974	1
180500	PG	PG9 180530	0,097	1
180502	PG	PG11 180530	0,106	1
180504	PG	PG13,5 180530	0,115	1
180506	PG	PG16 180530	0,100	1
180508	PG	PG21 180530	0,176	1
180510	PG	PG29 180532	0,400	1
180512	PG	30,5 180534	0,202	1
180514	PG	PG36 180534	0,590	1
180516	PG	PG42 180534	1,250	1
180518	PG	PG48 180534	0,319	1
180520	PG	1 1/8" 180530	0,250	1

Spare screws

Spare screws for screw punches



Art. no.	size	kg	PU
180530	M 10 x 1,0	0,048	1
180532	M 12 x 1,5	0,070	1
180534	M 16 x 1,5	0,139	1



Rotary guide value for step drills/cone drills

Material	unleg. Baustahl < 700 N/mm ² Mild steel < 700 N/mm ²	unleg. Baustahl > 700 N/mm ² Mild steel > 700 N/mm ²	leg. Stahl < 1000 N/mm ² Alloy steel < 1000 N/mm ²	Gußeisen < 250 N/mm ² Cast iron < 250 N/mm ²	Gußeisen > 250 N/mm ² Cast iron > 250 N/mm ²	Edelstahl rostfrei Stainless steel	CuZn Leg. spröde CuZn alloy brittle	CuZn Leg. zäh CuZn alloy tough	AL Leg. < 11% Si Alloy steel < 11% Si	Thermo- plaste Thermo plastic	Duro- plaste Duro plastic	Holz Wood
Materialstärke	6,0 mm	6,0 mm	6,0 mm	6,0 mm	6,0 mm	3,0 mm	6,0 mm	6,0 mm	6,0 mm	6,0 mm	6,0 mm	25,0 mm
Kühlung	Bohrpaste	Bohrpaste	Bohrpaste	Luft	Luft	Bohrpaste	Luft	Luft	Bohrpaste	H ² O	Luft	Luft
Lubricant	Drilling paste	Drilling paste	Drilling paste	Air	Air	Drilling paste	Air	Air	Drilling paste	H ² O	Air	Air
Vc = m / min	25	20 - 25	20	15	10	5	60	35	30	20	15	> 40
Ø mm	U/min r.p.m	U/min r.p.m	U/min r.p.m	U/min r.p.m	U/min r.p.m	U/min r.p.m	U/min r.p.m	U/min r.p.m	U/min r.p.m	U/min r.p.m	U/min r.p.m	U/min r.p.m
4,0 - 12,0	1900 - 600	1700 - 580	1550 - 520	1190 - 400	800 - 250	400 - 130	4700 - 1550	2750 - 920	2350 - 790	1550 - 520	1190 - 400	3000 - 1000
4,0 - 20,0	1900 - 400	1700 - 350	1550 - 300	1190 - 240	800 - 160	400 - 80	4700 - 950	2750 - 550	2350 - 470	1550 - 300	1190 - 240	3000 - 650
12,0 - 20,0	600 - 400	600 - 350	520 - 300	400 - 240	250 - 160	130 - 80	1550 - 950	920 - 550	790 - 470	520 - 300	400 - 240	1000 - 650
4,0 - 24,0	1900 - 300	1700 - 280	1550 - 250	1190 - 200	800 - 130	400 - 65	4700 - 790	2750 - 460	2350 - 400	1550 - 250	1190 - 200	3000 - 550
6,0 - 30,0	1300 - 250	1200 - 230	1000 - 200	780 - 150	530 - 100	250 - 50	3150 - 630	1850 - 370	1590 - 310	1000 - 200	780 - 150	2100 - 420
20,0 - 30,0	400 - 250	350 - 230	300 - 200	230 - 150	160 - 100	80 - 50	950 - 630	550 - 370	470 - 310	300 - 200	230 - 150	650 - 420
6,0 - 36,0	1300 - 220	1200 - 200	1000 - 170	780 - 130	530 - 90	250 - 45	3150 - 530	1850 - 300	1590 - 260	1000 - 170	780 - 130	2100 - 350
30,0 - 40,0	250 - 200	230 - 180	200 - 150	150 - 120	100 - 80	50 - 40	630 - 470	370 - 280	310 - 240	200 - 150	150 - 120	420 - 310
40,0 - 50,0	200 - 160	180 - 140	150 - 125	120 - 90	80 - 65	40 - 30	470 - 380	280 - 220	240 - 190	150 - 125	120 - 90	310 - 250
50,0 - 60,0	160 - 130	140 - 110	125 - 100	90 - 80	65 - 50	30 - 25	380 - 310	220 - 185	190 - 150	125 - 100	90 - 80	250 - 210



Diamond hollow core cutters

Diamond hollow core cutters

Carrier turned from solid material, suitable for soft materials and brickwork, concrete and artificial stone, takes M 16, without receiving shaft and centre drill, laser-welded, use only without impact



Art. no.	∅	shank	kg	PU
230676	68	-	0,453	1
230677	82	-	0,590	1

Diamond hollow core cutters

shank M 16, with tapered cylindrical drill bit, laser-welded, use only without impact



Art. no.	∅	shank	kg	PU
230676/K	68	SDS-plus	0,672	1
230677/K	82	SDS-plus	0,764	1

Diamond hollow core cutter special

Diamond drill bit for socket outlets with laser welded segments, suitable for soft materials and brickwork, concrete and artificial stone, optimal rotating speed 800 - 1.000 U/min, maximum rotating speed 1.600 - 1.800 U/min, use only without impact



Art. no.	∅	shank	kg	PU
230885/K	68	SDS-plus	0,450	1
230886/K	82	SDS-plus	0,787	1

Drill for Diamond hollow core cutters

tapered shank



Art. no.	TL	∅	kg	PU
230679	120	9	0,044	1

Shank for hollow core cutters, SDS-Plus

SDS-Plus-shank, M 16, conic



Art. no.	TL	shank	kg	PU
230681/K	100	SDS-plus	0,150	1

haupa[®]

...convincing solutions

Cutting discs

Diamond cutting blades

laser-welded, high diamond concentration, long life, for the professional works
- Industrial quality -



Art. no.	Ø		kg	PU
230689	115		0,100	1
230691	125		0,149	1
230720	135	(FUBAG)	0,193	1
230721	140	(FLEX)	0,219	1
230704	150		0,245	1
230705	180		0,317	1
230706	230		0,700	1
230711	300		1,256	1

Diamond cutting blades

sintered - Profi Quality -



Art. no.	Ø		kg	PU
230701	115		0,132	1
230702	125		0,169	1
230708	180		0,339	1
230709	230		0,681	1

Diamond cutting blades, TBM Turbo

- Profi quality -



Art. no.	Ø		kg	PU
230722	115		0,120	1
230723	125		0,134	1
230725	230		0,706	1

INFO

Diamond cutting discs

Industrial quality

A new generation for metalworking.

These HAUPA discs can cut **everything but stone!** From iron, stainless steel, PVC etc. through to wood, simply everything. This is a special feature and innovative since these cutting discs are usually only used for cutting stone.

The advantage of these diamond cutting discs compared to an ordinary disc is, above all, the durability, which is 20-40 times the norm! And there is no limit on storage. Ordinary cutting discs will become porous after 2-3 years. HAUPA cutting discs can be stored for a lifetime and beyond. The main arguments in favour of the HAUPA cutting discs are the fact that the diameter is never reduced, there is a much lower incidence of sparks and thus considerably less odour is produced.

All the benefits at a glance:

- Versatile scope of application (metal profiles, iron, die cast, steel, steel pipes, wood, Inox, GRP, CFP, polycarbonate, stoneware, fine stoneware)
- Constantly maintained diameter, thus always full cutting depth
- High cutting speed
- High level of durability (20 - 40 times more than normal, depending on materials cut)
- Reduced incidence of sparks
- Reduced odour development
- Unlimited storage times

Diamond cutting disk „Spezial“



Short-toothed vacuum coating of a new generation for metal work. High diamond concentration enables the processing of materials impossible with traditional diamond tools.

- Versatile areas of application (metal profiles, iron, cast, steel, steel pipes, wood, Inox, GRP, CFRP, polycarbonate, masonry, fine masonry)
- High cutting speed
- High stand time
- Reduced spark formation
- Reduced odour development
- Can be stored with no time restrictions
- Constant diameter, thus always full cutting depth

Video 230727

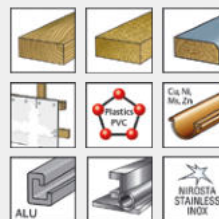

LONG LIFE



Art. no.	Ø		kg	PU
230727	115		0,120	1
230731	125	*	0,134	1



INFO

Hole saws

Industrial quality

The performance of a saw blade depends on the base material quality, the kind of toothing and the tooth geometry. These factors guarantee in conjunction with the correct use of the machine and blade selection the optimum result in cutting all materials.

- Above average concentricity
- Even cutting performance
- Extremely quiet operation even at high speeds
- True diameter
- High resistance even with high loads and torques
- Fast progress thanks to aggressive and permanently sharp cutting performance
- Highest lifetime even with very hard materials such as cast and stainless steel

T.C.T. Hole Saw

High concentricity and smooth cutting through strong construction. Precise and clean cut. Large tungsten carbide inserts for reshaping and long lifetime. Hole saw comes complete with shank, drill bit, ejector spring and allen key. Long lifetime. **Especially for:** Flat materials of steel, cast steel, stainless steel (up to 4 mm), Chrome-nickel Steel (up to 2 mm), non-ferrous metals, glassfibre and carbon-fibre reinforced products (CRP, GRP), epoxy, reinforced textures and sandwich-materials (up to 6 mm).

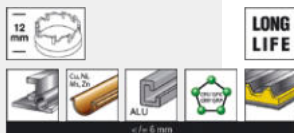

Art. no.	Ø	St	drill-Ø	kg	PU
392100	16	12	6,5	0,095	1
392102	20	31	6,5	0,115	1
392104	22	31	6,5	0,135	1
392106	22,5	31	6,5	0,155	1
392108	25	31	6,5	0,175	1
392110	30	31	6,5	0,195	1
392112	32	31	6,5	0,215	1
392114	35	31	6,5	0,235	1
392116	40	31	6,5	0,255	1
392118	50	31	6,5	0,275	1
392120	60	31	6,5	0,295	1

T.C.T. center drill for hole saw arbors



Art. no.	TL	Ø	kg	PU
392122	100	6,5	0,020	1

Spring for hole saw arbors



Art. no.	spring	kg	PU
392124		0,005	1

T.C.T. Hole Saw Fastcut

Very fast and aggressive cut in wood due to large exhaust slots. **Especially for:** wood materials up to 60 mm.



Art. no.	Ø/Inch	Ø	St	drill-Ø	kg	PU
231942	3/4	19	50	6,35	0,047	1
231944	7/8	22	50	6,35	0,062	1
231946	1	25	50	6,35	0,077	1
231950	1 3/16	30	50	6,35	0,115	1
231952	1 1/4	32	50	6,35	0,122	1
231954	1 3/8	35	50	6,35	0,133	1
231956	1 9/16	40	50	6,35	0,123	1
231958	1 3/4	44	50	6,35	0,144	1
231960	2	51	50	6,35	0,179	1
231962	2 1/8	54	50	6,35	0,198	1
231964	2 3/8	60	50	6,35	0,206	1
231966	2 1/2	64	50	6,35	0,267	1
231968	2 9/16	65	50	6,35	0,279	1
231970	2 11/16	68	50	6,35	0,275	1
231972	2 3/4	70	50	6,35	0,316	1
231974	3	76	50	6,35	0,298	1
231976	3 1/8	79	50	6,35	0,379	1
231978	3 1/4	83	50	6,35	0,428	1
231980	4	102	50	6,35	0,591	1
231982	4 1/2	114	50	6,35	0,773	1

Hollow saws

Bi-Metal Hole Saws 10 tpi

8% Cobalt

Finely toothed, 10 tpi, made of high quality, cobalt-alloyed bi-metal for clean and fast cuts and a long lifetime. Massive back plate ensures a smooth cut and precise holes for threads, cable and pipe lead-throughs. **Especially for:** steel and stainless steel, sheet metal up to 1 mm.



Art. no.	Ø	St	drill-Ø	kg	PU
392050	16	31	6,5	0,036	1
392052	19	31	6,5	0,039	1
392054	20	31	6,5	0,046	1
392056	21	31	6,5	0,052	1
392058	22	31	6,5	0,055	1
392060	24	31	6,5	0,059	1
392062	25	31	6,5	0,064	1
392064	29	31	6,5	0,070	1
392066	30	31	6,5	0,077	1
392070	38	31	6,5	0,092	1
392072	40	31	6,5	0,098	1

Hole saw with edge countersink and board ejector

For setting wall-flush sockets, Ø 68 mm

- Cutting depth 36 mm
- High concentricity
- Specially for plasterboard, softwood, plywood, Fermacell etc.
- 9,5 mm hexagonal holder
- In plastic box



Art. no.	Ø/Inch	Ø	drill-Ø	St	kg	PU
231929	2 11/16	68	6,35	35	0,360	1

Bi-Metal Hole Saws 4 - 6 tpi

8% Cobalt

Variable toothing of 4 - 6 tpi and high quality, cobaltalloyed bi-metal for clean and fast cuts and a long lifetime. Massive back plate ensures a smooth cut and precise holes for sockets, threads, cable and pipe lead-throughs. **Especially for:** Wood, gypsum board, plastics, non-ferrous metals, aluminium steel and stainless steel minimum 1 mm. Special cutting depth on request.



Art. no.	Ø/Inch	Ø	St	drill-Ø	kg	PU
231803	9/16	14	30	6,35	0,036	1
231900	3/4	19	35	6,35	0,036	1
231901/21		21	30	6,5	0,050	1
231902	7/8	22	35	6,35	0,046	1
231904	1	25	35	6,35	0,071	1
231904/29		29	30	6,5	0,050	1
231906	1 1/6	27	35	6,35	0,075	1
231908	1 3/16	30	35	6,35	0,079	1
231910	1 1/4	32	35	6,35	0,085	1
231912	1 3/8	35	35	6,35	0,092	1
231912/38		38	30	6,5	0,050	1
231914 *	1 9/16	40	35	6,35	0,086	1
231914/46		46	30	6,5	0,050	1
231916	1 3/4	44	35	6,35	0,105	1
231918 *	2	51	35	6,35	0,133	1
231920	2 1/8	54	35	6,35	0,145	1
231922	2 3/8	60	35	6,35	0,168	1
231924	2 1/2	64	35	6,35	0,192	1
231926	2 9/16	65	35	6,35	0,198	1
231928 *	2 11/16	68	35	6,35	0,214	1
231930	2 3/4	70	35	6,35	0,223	1
231931 *	2 7/8	73	35	6,35	0,236	1
231932	3	76	35	6,35	0,253	1
231934	3 1/8	79	35	6,35	0,275	1
231936 *	3 1/4	83	35	6,35	0,304	1
231938	4	102	35	6,35	0,429	1
231939/111		111	30	6,5	0,050	1
231940	4 1/2	114	35	6,35	0,549	1
231940/127		127	30	6,5	0,050	1
231940/152		152	30	6,5	0,650	1
231940/210		210	30	6,5	0,850	1

Adapter for hollow saws

INFO

Professional Quick Release System for Hole Saws

- Change quickly in seconds between the different diameters and various types of hole saws.
- One arbor for all diameters between 14 - 210 mm.
- Absolute concentricity and diameter true to size.
- Compact "heavy duty" design for highest demands and very long life.
- No time-consuming seizing up of the hole saw onto the thread of the arbor.
- Runs two hole saws at the same time. A smaller diameter guides as a centering aid when enlarging already existing holes.
- Fits all standard hole saw brands.*

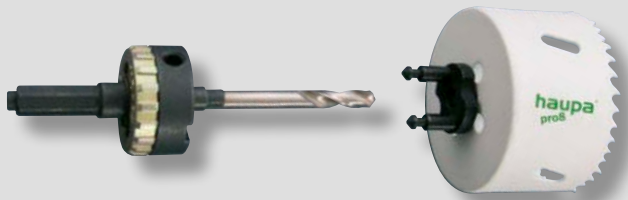

*With 1/2" (20 UNF) or 5/8" (18 UNF) thread.

Quick change holder for hole saws „RE-LOAD“

RE-LOAD

for all diameters from 14-210 mm, 9.5 mm hexagonal shank



Art. no.	size	shankt/Ø	kg	PU
392010	14 - 210	9,5	0,100	1

Adapter assortment for holder „RE-LOAD“

RE-LOAD



Art. no.	set	kg	PU
392012	5 x Ø 14-30 mm	0,100	1
392014	5 x Ø 32-210 mm	0,075	1
392016	2 x Ø 14-30 mm, 3 x Ø 32-210 mm	0,065	1

Adapter assortment for hole enlarger „RE-LOAD“

RE-LOAD

1 x Ø 14 - 30 mm, 1 x Ø 32 - 210 mm



Art. no.	size	shankt/Ø	kg	PU
392018	14 - 210	9,5	0,050	1

Centre drill for holder „RE-LOAD“

RE-LOAD



Art. no.	TL	Ø	kg	PU
392020	100	6,5	0,030	1

Hex shank with plug ejection

hexagon shank



Art. no.	size	shankt/Ø	kg	PU
392028	32 - 210	9,5	0,050	1

SDS-shank

11 mm (14 - 30 mm)



Art. no.	size	shankt/Ø	kg	PU
392024	14 - 30	11	0,050	1

SDS-shank

11 mm (32 - 210 mm)



Art. no.	size	shankt/Ø	kg	PU
392026	32 - 210	11	0,050	1

Centre drill for holder 392024 | 392026 | 392028



Art. no.	TL	Ø	kg	PU
392022	100	6,5	0,030	1

Adapter „QuickLock“

hexagon shank



Art. no.	size	shank	kg	PU
231998	14-30	hexagon	0,067	1
231999 *	32-152	hexagon	0,107	1

Centre drills for 231998 / 231999



Art. no.	TL	type	Ø	shank	kg	PU
232007	120	universal	9	hexagon	0,020	1

haupa®

...convincing solutions

Bi-metal hole saw set

RE-LOAD

Set in black plastic case, dimensions: 255 x 210 x 72 mm

Contents:

- Hole saws bi-metal 35 mm
- Hole saws bi-metal 68 mm
- Hole saws bi-metal 76 mm
- Quick change holder for hole saws „RE-LOAD“
- 3 adapters for holder „RE-LOAD“ 32 – 210 mm

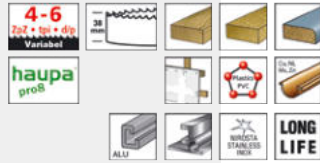

Art. no.	Content	kg	PU
231984	7-pieces	1,300	1

Bi-metal hole saw set „QuickChange“

Set in black plastic case, dimensions: 255 x 210 x 72 mm

Contents:

- Hole saws bi-metal 35 mm
- Hole saws bi-metal 40 mm
- Hole saws bi-metal 51 mm
- Hole saws bi-metal 68 mm
- Hole saws bi-metal 73 mm
- Hole saws bi-metal 83 mm
- Adapter „QuickLock“

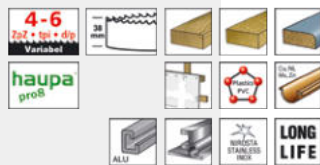

Art. no.	Content	kg	PU
230002	7-pieces	1,785	1

Compass saw set bi-metal

NEW

9-recess set in a black plastic case, variable toothing with 4/6 teeth, high-quality, cobalt-alloy bi-metal for optimum cutting quality and long life span. Solid rear lid enables very smooth running and precise holes for plug sockets, thread, cables and pipe openings etc.

Ideal for: Wood, plasterboard, plastic, non-ferrous metals, aluminium, steel and stainless steel, from 1 mm thick.

Content:

- HSS bi-metal compass saws Ø 22mm (231902), Ø 27mm (231906), Ø 32mm (231910), Ø 44mm (231916), Ø 68mm (231928), Ø 76mm (231932), Ø 83mm (231936)
- Drill holder, „QuickLock“ with hexagonal receiver: Size 14-30 (231998) and size 32-152 (231999)

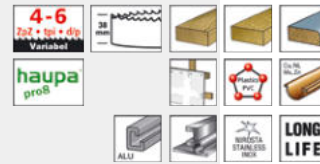

Art. no.	Content	kg	PU
232011	9-pieces	1,850	1

Drilling tools



Threading bits, taps

HSS taps "Direct cutter"

with intermittent teeth, dimensions to DIN 371, or ISO metric thread to DIN 13



Art. no.	shank	thread	kg	PU
230982	4,5	4	0,008	1
230984	6	5	0,014	1
230986	6	6	0,017	1
230988	6	8	0,012	1

Taps for armoured steel conduits, metric thread



Art. no.	thread	kg	PU
140236	16	0,040	1
140238	20	0,060	1
140240	25	0,206	1
140242	32	0,359	1
140244	40	0,648	1
140246	50	0,230	1
140248	63	1,688	1

Adjustable tap wrenches

short pattern



Art. no.	thread	tap wrench	kg	PU
140180	M 7-25	21	0,850	1
140182	M 32-63	48	1,900	1

Nipple threading dies

with guide, replaceable dies and taps



Art. no.	thread	kg	PU
140190	M 10	0,100	1
140192	M 13	0,130	1

Nipple threading dies

with guide, replaceable dies and tap



Art. no.	thread	kg	PU
140210	M 10, M 13	0,210	1

Complete stocks, metric thread



Art. no.	thread	kg	PU
140214	M 16, M 20, M 25	1,000	1
140216	M 20, M 25	1,350	1
140218	M 32, M 40	2,850	1
140220	M 50, M 63	3,500	1

Dies, metric thread



Art. no.	Dimensions	thread	kg	PU
140222	47 x 47	M16	0,175	1
140224	47 x 47	M20	0,138	1
140226	47 x 47	M25	0,145	1
140228	70 x 70	M32	0,477	1
140230	70 x 70	M 40	0,130	1
140232	100 x 100	M 50	0,980	1
140234	100 x 100	M 63	0,791	1

Guides, metric



Art. no.	thread	kg	PU
140250	16	0,037	1
140252	20	0,040	1
140254	25	0,035	1
140256	32	0,030	1
140258	40	0,060	1
140260	50	0,070	1
140262	63	0,134	1

Screw extractor set



Art. no.	size	kg	PU
230682	1-5/M3-18	0,111	1
230683	1-6/M3-24	0,231	1

Hand taps DIN 352, type N/HSS

set of 3, for ISO metric thread to DIN, 1, 2, 3-cutter, made of HSS, for pass-through threading, for good chipping steel up to approx. 900 N/mm²



Art. no.	shankt/Ø	thread	kg	PU
230800	2,5	1	0,010	1
230802	2,5	1,4	0,010	1
230804	2,5	1,6	0,002	1
230806	2,5	1,8	0,002	1
230808	2,8	2	0,002	1
230810	2,8	2,2	0,002	1
230812	2,8	2,5	0,002	1
230814	3,5	3	0,003	1
230816	4	3,5	0,004	1
230818	4,5	4	0,004	1
230820	5,5	4,5	0,005	1
230822	6	5	0,034	1
230824	6	6	0,035	1
230826	6	7	0,039	1
230828	6	8	0,046	1
230830	7	9	0,065	1
230832	7	10	0,071	1
230834	8	11	0,025	1
230836	9	12	0,115	1
230838	11	14	0,052	1
230840	12	16	0,062	1
230842	14	18	0,102	1
230844	16	20	0,125	1
230846	18	22	0,182	1
230848	18	24	0,205	1
230850	20	27	0,260	1
230852	22	30	0,395	1
230854	25	33	0,480	1
230856	28	36	0,645	1
230858	32	39	0,820	1
230860	32	42	0,930	1
230862	36	45	1,140	1
230864	36	48	1,370	1
230866	40	52	1,650	1
230868	45	56	2,800	1
230870	45	60	2,900	1

Ratchet wrenches

for right-hand and left-hand action



art. 231070

art. 231072

Art. no.	thread	Zoll	TL	shank	kg	PU
231070	M3 - 10	1/8 - 3/8	85	2,4 - 5,5	0,173	1
231072	M5 - 12	7/32 - 1/2	100	4,5 - 8,0	0,272	1
231074	M3 - 10	1/8 - 3/8	250	2,4 - 5,5	0,250	1
231076	M5 - 12	7/32 - 1/2	300	4,5 - 8,0	0,440	1

HSS taps set

with taps to DIN 352, in metal box,

Contents: M3, M 4, M 5, M 6, M 8, M 10, M 12



Art. no.	set	kg	PU
231080	23-pieces	0,696	1

Combi, threading bit set, made of HSSG SGE-Bit (DBGM)

for drilling, threading and countersinking, for stand drilling machines and hand drills, suitable for steel and NE metal up to 1 xd (M 6 = 6 mm thickness of material), up to 600 N/mm² tensile strength, rpm according to the cutting speeds of the tride, in metal box

Contents: M 3, 4, 5, 6, 8, 10



Art. no.	set	kg	PU
231082	7-pieces	0,188	1

Adjustable tap wrenches DIN 1814

for taps



Art. no.	thread	tap wrench	kg	PU
231050	M1 - 8	0	0,050	1
231052	M1 - 10	1	0,099	1
231054	M1 - 12	1,5	0,097	1
231056	M4 - 12	2	0,285	1
231058	M5 - 21	3	0,700	1
231060	M9 - 27	4	1,270	1
231062	M12 - 33	5	1,630	1
231064	M19 - 38	6	4,520	1

haupa[®]

...convincing solutions

Threading bits, taps

HSS Tap set

Contents:

hand tap (DIN 352) M 3, 4, 5, 6, 8, 10, 12
Dies (DIN 223) M 3, 4, 5, 6, 8, 10, 12,
Dies stock 20 x 5/20 x 7/25 x 9/30 x 11/38 x 14 mm
tape holder size 1 + 2, in a practical plastic case



Art. no.	set	kg	PU
231280	23-pieces	3,700	1

HSS Tap set

Contents:

Hand tap (DIN 352) M 3, 4, 5, 6, 8, 10, 12, 14, 16, 18, 20
Dies (DIN 223) M 3, 4, 5, 6, 8, 10, 12, 14, 16, 18, 20
Dies holder 20 x 7/25 x 9/30 x 11/38 x 14/ 45 x 18 mm
Tap holder size 1, 2 + 3, in a practical plastic case



Art. no.	set	kg	PU
231282	25-pieces	8,200	1

Screws, dowels



Universal countersunk screw

Chipboard screw, galvanised, counter-sunk head, Pozidriv



Art. no.	TL	Ø	drive	kg	PE	PU
790005	15	3,0	PZ	2	0,002	100 200
790006	25	3,0	PZ	2	0,002	100 200
790008	40	3,0	PZ	2	0,002	100 200
790015	20	3,5	PZ	2	0,001	100 200
790016	25	3,5	PZ	2	0,001	100 200
790017	30	3,5	PZ	2	0,002	100 200
790018	35	3,5	PZ	2	0,002	100 200
790079	40	3,5	PZ	2	0,002	100 200
790027 *	30	4,0	PZ	2	0,002	100 200
790029 *	40	4,0	PZ	2	0,002	100 200
790030 *	45	4,0	PZ	2	0,003	100 200
790031	50	4,0	PZ	2	0,003	100 200
790040	35	4,5	PZ	2	0,003	100 200
790041 *	40	4,5	PZ	2	0,003	100 200
790043	50	4,5	PZ	2	0,004	100 200
790051	30	5,0	PZ	2	0,003	100 100
790053	40	5,0	PZ	2	0,004	100 100
790054	50	5,0	PZ	2	0,005	100 100
790055	60	5,0	PZ	2	0,005	100 100
790056	80	5,0	PZ	2	0,007	100 100
790063	50	6,0	PZ	3	0,007	100 100
790064	60	6,0	PZ	3	0,008	100 50
790065	80	6,0	PZ	3	0,011	100 50

Universal pan head screw

Fibreboard screws, galvanised, pan head Pozidriv



Art. no.	TL	Ø	drive	kg	PE	PU
790090	25	3,5	PZ	2	0,002	100 200
790091	30	3,5	PZ	2	0,002	100 200
790093	40	3,5	PZ	2	0,002	100 200
790100	30	4,0	PZ	2	0,002	100 200
790101	35	4,0	PZ	2	0,002	100 200
790102 *	40	4,0	PZ	2	0,003	100 200
790103	45	4,0	PZ	2	0,003	100 200
790104	50	4,0	PZ	2	0,003	100 200
790111	40	4,5	PZ	2	0,004	100 200
790112	45	4,5	PZ	2	0,004	100 200
790113	50	4,5	PZ	2	0,004	100 200
790118	30	5,0	PZ	2	0,004	100 200
790120	40	5,0	PZ	2	0,005	100 200
790121	50	5,0	PZ	2	0,005	100 200

Hexagonal wood screws, hot zinc dipped

in accordance with DIN 571, hot zinc dipped, general requirements according to DIN 267 Part 1



Art. no.	TL	Ø	WS	kg	PE	PU
790212/V	80	6	10	Hexagon	0,015	100 25
790223/V *	60	8	13	Hexagon	0,021	100 25
790224/V	80	8	13	Hexagon	0,027	100 25
790235/V	60	10	17	Hexagon	0,036	100 10

Dry wall screws

galvanised, counter-sunk head, Tx



Art. no.	TL	Ø	drive	kg	PE	PU
790920	32	3,9	Torx	20	0,002	100 200
790922	41	3,9	Torx	20	0,002	100 200

Chipboard screw countersunk „TwinSpeed“

Chipboard screw, galvanised, counter-sunk head, Tx, double helix thread, considerably shortened screw-in times when compared to traditional screws thanks to the double start thread.

Uses: Wood, plywood, plasterboard, rawlplugs



Art. no.	TL	Ø	drive	kg	PE	PU
793005	16	2,9	Torx	10	0,002	100 200
793006	25	2,9	Torx	10	0,002	100 100
793007	32	2,9	Torx	10	0,002	100 100
793008	38	2,9	Torx	10	0,002	100 100
793027	32	3,9	Torx	15	0,002	100 100
793029	38	3,9	Torx	15	0,002	100 100
793030	45	3,9	Torx	15	0,003	100 100
793031	50	3,9	Torx	15	0,003	100 100
793040	32	4,2	Torx	20	0,003	100 100
793041	38	4,2	Torx	20	0,003	100 100
793043	50	4,2	Torx	20	0,004	100 100
793051	30	4,8	Torx	25	0,003	100 100
793053	38	4,8	Torx	25	0,004	100 100
793054	50	4,8	Torx	25	0,005	100 100
793055	60	4,8	Torx	25	0,005	100 100
793064	60	6,3	Torx	30	0,008	100 50
793065	80	6,3	Torx	30	0,011	100 50

Chipboard screw pan head „TwinSpeed“

Chipboard screw, galvanised, pan head, Tx, double helix thread, considerably shortened screw-in times when compared to traditional screws thanks to the double start thread.

Uses: Wood, plywood, plasterboard, rawlplugs



Art. no.	TL	Ø	drive	kg	PE	PU
793099	20	3,9	Torx	15	0,002	100 100
793100	32	3,9	Torx	15	0,002	100 100
793101	35	3,9	Torx	15	0,002	100 100
793102	38	3,9	Torx	15	0,003	100 100
793103	45	3,9	Torx	15	0,003	100 100
793104	50	3,9	Torx	15	0,003	100 100
793111	38	4,2	Torx	20	0,004	100 100
793112	45	4,2	Torx	20	0,004	100 100
793113	50	4,2	Torx	20	0,004	100 100
793118	32	4,8	Torx	25	0,004	100 100
793120	38	4,8	Torx	25	0,005	100 100
793121	50	4,8	Torx	25	0,005	100 100
793125	60	6,3	Torx	30	0,002	100 50

Hexagonal wood screws

in accordance with DIN 571, galvanised, general requirements according to DIN 267 Part 1



Art. no.	TL	Ø	WS	kg	PE	PU
790210	40	6	10	Hexagon	0,008	100 50
790211	60	6	10	Hexagon	0,012	100 25
790212	80	6	10	Hexagon	0,015	100 25
790222	50	8	13	Hexagon	0,018	100 50
790223	60	8	13	Hexagon	0,021	100 25
790224	80	8	13	Hexagon	0,027	100 25
790225	100	8	13	Hexagon	0,033	100 25
790235	60	10	17	Hexagon	0,036	100 10
790236	80	10	17	Hexagon	0,048	100 10
790237	100	10	17	Hexagon	0,055	100 10

Hooks

galvanised



Art. no.	Ø	SftL	kg	PE	PU
790900	4,2	50	0,006	100	50
790902	5,8	80	0,008	100	10

Tin screws, assembly screws

TwinSpeed self tapping screw



galvanised, pan head, Phillips cross-head and double helix thread, considerably shortened screw-in times when compared to traditional screws thanks to the double start thread. Uses: Wood, plywood, plasterboard, rawplugs



Art. no.	TL	Ø	drive	kg	PE	PU	
790303	19	3,5	Phillips PH	2	0,001	100	100
790311	32	3,5	Phillips PH	2	0,002	100	100
790325	13	4,2	Phillips PH	2	0,001	100	100
790326	16	4,2	Phillips PH	2	0,001	100	100
790327	19	4,2	Phillips PH	2	0,001	100	100
790329	25	4,2	Phillips PH	2	0,002	100	100
790332	31	4,2	Phillips PH	2	0,002	100	100
790333	38	4,2	Phillips PH	2	0,003	100	100
790334	45	4,2	Phillips PH	2	0,003	100	100
790335	65	4,2	Phillips PH	2	0,005	100	100

Plate screw DIN 7504



in accordance with DIN 7504M (formerly N), self-tapping, hardened steel, galvanised, pan head with Phillips slot, plate screw thread according to DIN 7970



Art. no.	TL	Ø	drive	kg	PE	PU	
790411	13	3,5	Phillips PH	2	0,001	100	200
790413	19	3,5	Phillips PH	2	0,001	100	200
790416	13	3,9	Phillips PH	2	0,001	100	200
790417	16	3,9	Phillips PH	2	0,002	100	200
790419	25	3,9	Phillips PH	2	0,002	100	200
790422	13	4,2	Phillips PH	2	0,002	100	200
790423	16	4,2	Phillips PH	2	0,002	100	200
790424	19	4,2	Phillips PH	2	0,002	100	200
790426	25	4,2	Phillips PH	2	0,002	100	200
790428	32	4,2	Phillips PH	2	0,002	100	200
790432	13	4,8	Phillips PH	2	0,002	100	200
790433	16	4,8	Phillips PH	2	0,003	100	200
790434	19	4,8	Phillips PH	2	0,003	100	200
790436	25	4,8	Phillips PH	2	0,003	100	200

Plate screw DIN 7504, Tx



in accordance with DIN 7504M (formerly N), self-tapping, hardened steel, galvanised, Tx, plate screw thread according to DIN 7970



Art. no.	TL	Ø	drive	kg	PE	PU	
790510	13	4,2	Torx	20	0,002	100	100
790512	16	4,2	Torx	20	0,002	100	100
790514	19	4,2	Torx	20	0,002	100	100
790516	25	4,2	Torx	20	0,002	100	100

Mounting screws



galvanised with washer, Philips cross-head, self-cutting



Art. no.	TL	Ø	drive	kg	PE	PU	
790450	13	4,2	Phillips PH	2	0,001	100	100
790452	25	4,2	Phillips PH	2	0,002	100	100
790454	31	4,2	Phillips PH	2	0,002	100	100
790456	45	4,2	Phillips PH	2	0,003	100	100

Mounting screws



self-cutting and self-boring, galvanised with washer, Tx



Art. no.	TL	Ø	drive	kg	PE	PU	
790500	13	4,2	Torx	20	0,001	100	100
790502	19	4,2	Torx	20	0,002	100	100
790504	25	4,2	Torx	20	0,002	100	100

Mounting screws



self-cutting and self-boring, galvanised with washer, Philips cross-head



Art. no.	TL	Ø	drive	kg	PE	PU	
790470 *	13	4,2	Phillips PH	2	0,001	100	100

Machinery screws, cylinder screws

Hexagonal machine screws



according to DIN 933, continuous thread, galvanised, 8.8 quality



Art. no.	TL	Ø	WS	kg	PE	PU
790540	20	M6	10	0,006	100	100
790542	25	M6	10	0,007	100	100
790544	30	M6	10	0,008	100	100
790562	20	M8	13	0,012	100	100
790564	25	M8	13	0,014	100	100
790566	30	M8	13	0,016	100	100
790588	20	M10	17	0,023	100	100
790592	30	M10	17	0,028	100	100
790616	30	M12	19	0,040	100	50
790618	40	M12	19	0,047	100	50

Socket cup screw DIN 84 Form A



in accordance with ISO 1207, EN 21207 or DIN 84, Form A, with slit, made of hardened steel, galvanised, 4.8 quality



Art. no.	TL	Ø	drive	kg	PE	PU
790806	16	M3	slot 5,5x0,8	0,001	100	200
790808	20	M3	slot 5,5x0,8	0,001	100	200
790832	16	M4	slot 7,0x1,2	0,002	100	200
790834	20	M4	slot 7,0x1,2	0,002	100	200
790837	30	M4	slot 7,0x1,2	0,003	100	200
790862	16	M5	slot 8,5x1,2	0,003	100	200
790864	20	M5	slot 8,5x1,2	0,004	100	200
790867	30	M5	slot 8,5x1,2	0,005	100	200
790882	16	M6	slot 10,0x1,6	0,005	100	200
790884	20	M6	slot 10,0x1,6	0,055	100	200
790888	30	M6	slot 10,0x1,6	0,007	100	200

Machine screw counter sunk



continuous thread, zinc-plated, pan headed Pozidriv



Art. no.	TL	Ø	drive	kg	PE	PU	
790700	20	M3	Pozidriv PZ	2	0,001	100	100
790702	30	M3	Pozidriv PZ	2	0,001	100	100
790704	40	M3	Pozidriv PZ	2	0,002	100	100
790706	50	M3	Pozidriv PZ	2	0,002	100	100
790710	20	M4	Pozidriv PZ	2	0,002	100	100
790712	30	M4	Pozidriv PZ	2	0,003	100	100
790714	40	M4	Pozidriv PZ	2	0,003	100	100
790716	50	M4	Pozidriv PZ	2	0,004	100	100
790721	25	M5	Pozidriv PZ	2	0,004	100	100
790722	30	M5	Pozidriv PZ	2	0,004	100	100
790724	40	M5	Pozidriv PZ	2	0,005	100	100
790726	50	M5	Pozidriv PZ	2	0,007	100	100

haupa[®]

... convincing solutions

Hexagonal nuts, washers

Hexagonal nut DIN 934

in accordance with ISO 4032, EN 24032 or DIN 934, steel galvanised, 8 quality



Art. no.	M	WS	kg	PE	PU
792000	M3	5,5	0,001	100	200
792001	M4	7	0,001	100	200
792002	M5	8	0,001	100	200
792003	M6	10	0,002	100	200
792005	M8	13	0,005	100	200
792006	M10	17	0,011	100	200
792008	M12	19	0,010	100	100

Washers DIN 125

in accordance with ISO 7089, EN 27089 or DIN 125, Form A without chamfer, steel galvanised



Art. no.	M	d1	d4	kg	PE	PU
792600	M3	3,2	7	0,000	100	200
792602	M4	4,3	9	0,000	100	200
792603	M5	5,3	10	0,001	100	200
792604	M6	6,4	12	0,001	100	200
792606	M8	8,4	16	0,002	100	200
792607	M10	10,5	20	0,003	100	200

Washers

in accordance with ISO 7093, DIN 9021N, zinc-plated steel



Art. no.	M	d1	d4	kg	PE	PU
792650	M4	4,3	12	0,001	100	100
792651	M5	5,3	15	0,001	100	100
792652	M6	6,4	20	0,012	100	100
792654	M8	8,4	25	0,011	100	100
792656	M10	10,5	40	0,010	100	100
792658	M12	13,0	40	0,010	100	100

Spring washers

according to DIN 127, form A, curved, zinc-plate steel



Art. no.	M	d1	d4	kg	PE	PU
792756	M6	6,4	11,8	0,001	100	100
792758	M8	8,4	14,8	0,002	100	100
792760	M10	10,5	18,1	0,003	100	100
792762	M12	13,0	21,1	0,004	100	100

Screws assortments

"Mix" Screws assortment box



Content: 1.425 screws, in plastic bulk storage chest 415 x 335 x 90 mm

Qty.	Description	Size	Drive	Art. no.
200	universal counter-sunk screws	3,5 x 20	PZ2	790015
200	universal counter-sunk screws	3,5 x 30	PZ2	790017
200	universal counter-sunk screws	3,5 x 40	PZ2	790079
200	universal counter-sunk screws	4,5 x 35	PZ2	790040
100	universal counter-sunk screws	4,5 x 50	PZ2	790043
50	universal counter-sunk screws	5,0 x 80	PZ2	790056
50	universal counter-sunk screws	6,0 x 50	PZ3	790063
200	universal pan head screws	3,5 x 30	PZ2	790091
100	universal pan head screws	4,0 x 40	PZ2	790102
50	universal pan head screws	5,0 x 50	PZ2	790121
50	hexagonal wood screws	6 x 40		790210
25	hexagonal wood screws	6 x 80		790212



Art. no.	empty	kg	PE	PU
792802	221131	5,022	1	1

"Pan head" Screws assortment box



Content: 1.700 screws, in plastic bulk storage chest 415 x 335 x 90 mm

Qty.	Description	Size	Drive	Art. no.
200	universal pan head screws	3,5 x 30	PZ2	790091
200	universal pan head screws	3,5 x 40	PZ2	790093
200	universal pan head screws	4,0 x 30	PZ2	790100
200	universal pan head screws	4,0 x 40	PZ2	790102
200	universal pan head screws	4,0 x 50	PZ2	790104
200	universal pan head screws	4,5 x 40	PZ2	790111
200	universal pan head screws	4,5 x 50	PZ2	790113
100	universal pan head screws	5,0 x 30	PZ2	790118
100	universal pan head screws	5,0 x 40	PZ2	790120
100	universal pan head screws	5,0 x 50	PZ2	790121
1	Bit-Box 17-pcs., incl. holder			102210



Art. no.	empty	kg	PE	PU
792804 *	221131	6,000	1	1

Screws assortments

“Countersunk” Screws assortment box



Content: 1.800 screws, in plastic bulk storage chest 415 x 335 x 90 mm

Qty.	Description	Size	Drive	Art. no.
200	universal counter-sunk screws	3,5 x 20	PZ2	790015
200	universal counter-sunk screws	3,5 x 30	PZ2	790017
200	universal counter-sunk screws	3,5 x 40	PZ2	790079
200	universal counter-sunk screws	4,0 x 30	PZ2	790027
200	universal counter-sunk screws	4,0 x 40	PZ2	790029
200	universal counter-sunk screws	4,0 x 50	PZ2	790031
200	universal counter-sunk screws	4,5 x 40	PZ2	790041
100	universal counter-sunk screws	5,0 x 40	PZ2	790053
100	universal counter-sunk screws	5,0 x 50	PZ2	790054
100	universal counter-sunk screws	5,0 x 60	PZ2	790055
50	universal counter-sunk screws	6,0 x 60	PZ3	790064
50	universal counter-sunk screws	6,0 x 80	PZ3	790065
1	Bit-Box 17-pcs., incl. holder			102210



Art. no.	empty	kg	PE	PU
792806	221131	5,000	1	1

“Countersunk” Screws assortment box



Content: 1.800 screws, in plastic bulk storage chest 415 x 335 x 90 mm

Qty.	Description	Size	Drive	Art. no.
200	universal counter-sunk screws	3,0 x 15	PZ2	790005
200	universal counter-sunk screws	3,0 x 25	PZ2	790006
200	universal counter-sunk screws	3,0 x 40	PZ2	790008
200	universal counter-sunk screws	4,0 x 30	PZ2	790027
200	universal counter-sunk screws	4,0 x 40	PZ2	790029
200	universal counter-sunk screws	4,0 x 50	PZ2	790031
200	universal counter-sunk screws	4,5 x 40	PZ2	790041
100	universal counter-sunk screws	5,0 x 40	PZ2	790053
100	universal counter-sunk screws	5,0 x 50	PZ2	790054
100	universal counter-sunk screws	5,0 x 60	PZ2	790055
50	universal counter-sunk screws	6,0 x 60	PZ3	790064
50	universal counter-sunk screws	6,0 x 80	PZ3	790065
1	Bit-Box 17-pcs., incl. holder			102210



Art. no.	empty	kg	PE	PU
792810	221131	5,000	1	1

“Mix Tx” Screws assortment box



Content: 1.475 screws, in plastic bulk storage chest 415 x 335 x 90 mm

Qty.	Description	Size	Drive	Art. no.
200	TwinSpeed counter-sunk screws	2,9 x 15	Tx10	793005
200	TwinSpeed counter-sunk screws	2,9 x 30	Tx10	793007
200	TwinSpeed counter-sunk screws	2,9 x 40	Tx10	793008
200	TwinSpeed counter-sunk screws	4,2 x 35	Tx20	793040
100	TwinSpeed counter-sunk screws	4,2 x 50	Tx20	793043
100	TwinSpeed counter-sunk screws	4,8 x 50	Tx25	793054
50	TwinSpeed counter-sunk screws	6,3 x 80	Tx30	793065
200	TwinSpeed pan head screws	3,9 x 30	Tx15	793100
100	TwinSpeed pan head screws	3,9 x 40	Tx15	793102
50	TwinSpeed pan head screws	4,8 x 50	Tx25	793121
50	hexagonal wood screws	6 x 40		790210
25	hexagonal wood screws	6 x 80		790212



Art. no.	empty	kg	PE	PU
792816	221131	5,022	1	1

„Mix“ Screws and dowel assortment box



Content: 700 screws, 425 dowel in plastic bulk storage chest 415 x 335 x 90 mm

Qty.	Description	Size	Art. no.
100	Expansion dowel sleeve	S6	794014
50	Expansion dowel sleeve	S8	794016
25	Expansion dowel sleeve	S10	794018
100	Countersunk nail dowel	5x50	794022
50	Countersunk nail dowel	6x40	794024
50	Countersunk nail dowel	6x60	794026
50	Countersunk nail dowel	6x80	794028
50	Universal pan head screw	4x35	790101
100	Universal pan head screw	5x40	790120
200	Universal countersunk screw	4x45	790030
200	Universal countersunk screw	5x50	790054
100	Universal countersunk screw	6x50	790063



Art. no.	empty	kg	PE	PU
792821	221131	5,000	1	1

haupa®

... convincing solutions

SysCon universal countersunk screws



Content: 1650 universal countersunk screws

- 1 220370 ABS plastic box „SysCon S“
- 1 220375 Foam „SysCon“ 400 x 300 x 10 mm
- 1 220399 Assortment insert „SysCon“

Qty.	Art. no.	Description	Size	Drive
400	790015	Universal countersunk screws	3,5 x 20	PZ2
200	790027	Universal countersunk screws	4,0 x 30	PZ2
200	790029	Universal countersunk screws	4,0 x 40	PZ2
200	790031	Universal countersunk screws	4,0 x 50	PZ2
200	790041	Universal countersunk screws	4,5 x 40	PZ2
100	790053	Universal countersunk screws	5,0 x 40	PZ2
100	790054	Universal countersunk screws	5,0 x 50	PZ2
100	790055	Universal countersunk screws	5,0 x 60	PZ2
50	790064	Universal countersunk screws	6,0 x 60	PZ3
100	790065	Universal countersunk screws	6,0 x 80	PZ3

SysCon plate screws



Content: 2000 universal screws

- 1 220370 ABS plastic box „SysCon S“
- 1 220375 Foam „SysCon“ 400 x 300 x 10 mm
- 1 220399 Assortment insert „SysCon“

Qty.	Art. no.	Description	Size	Drive
200	790327	Universal screw pan head	4,2 x 19	PH2
200	790329	Universal screw pan head	4,2 x 25	PH2
200	790332	Universal screw pan head	4,2 x 31	PH2
200	790333	Universal screw pan head	4,2 x 38	PH2
200	790450	Assembly screw pan head with washer	4,2 x 13	PH2
200	790452	Assembly screw pan head with washer	4,2 x 25	PH2
200	790456	Assembly screw pan head with washer	4,2 x 45	PH2
200	790470	Assembly screw with washer, self-tapping	4,2 x 13	PH2
200	790423	Plate screw DIN 750, 4M	4,2 x 16	PH2
200	790426	Plate screw DIN 750, 4M	4,2 x 25	PH2



Art. no.	empty	kg	PE	PU
220389	220370	7,000	1	1

Art. no.	empty	kg	PE	PU
220398	220370	5,000	1	1





Push-through expansion dowel

Suitability

- For all concrete and masonry building materials, with limitations for cavity building materials
- For fixing all items which can be attached using wood and chipboard screws

Features

- Three-way split of the expansion part for guiding screws perfectly and centrally
- Quicker installation and higher extraction value
- Support and rotating construction wedges ensure good anti-twist protection
- Optimum expansion behaviour in both solid and softer materials and in hollow and perforated bricks
- Passage opening in the dowel tip makes screwing easier

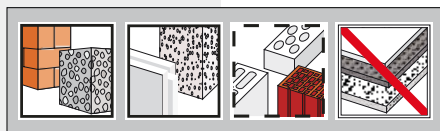

Art. no.	Ø x length	screw-Ø	depth	g	PrU	PU
794002	6 x 30	3,5 - 5,0	40	0,640	100	100
794004	8 x 40	4,5 - 6,0	50	1,380	100	100

Countersunk nail dowel

Suitability

- For concrete, solid brick, with limitations for aerated concrete and hollow concrete blocks

Features

- Time-saving fixing system consisting of one expansion dowel and one expansion nail
- Pre-assembled system: The expansion nail fixes firmly into the dowel.
- Hammer-in stop prevents premature expansion
- The dowel and fixed item can be removed by simply unscrewing the expansion nail from the dowel



Art. no.	Ø x length	screw	strength	g	PrU	PU
794020	5 x 30	PZ	5	2,670	100	100
794022	5 x 50	PZ	25	3,780	100	100
794024	6 x 40	PZ	10	4,070	100	50
794026	6 x 60	PZ	30	5,510	100	50
794028	6 x 80	PZ	50	7,360	100	50
794030	8 x 60	PZ	20	10,440	100	50

Expansion dowel sleeve

Suitability

- For all concrete and masonry building materials, with limitations for cavity building materials
- For fixing all items which can be attached using wood and chipboard screws

Features

- Three-way split of the expansion part for guiding screws perfectly and centrally
- Quicker installation and higher extraction value
- Support and rotating wedges ensure good anti-twist protection
- Optimum expansion behaviour in both solid and softer materials and in hollow and perforated bricks
- Passage opening in the dowel tip makes screwing easier
- with additional collar



Art. no.	Ø x length	screw-Ø	depth	g	PrU	PU
794012	5 x 25	2,5 - 4,0	35	0,390	100	100
794014	6 x 30	3,5 - 5,0	40	0,700	100	100
794016	8 x 40	4,5 - 6,0	50	1,570	100	50
794018	10 x 50	6,0 - 8,0	60	2,900	100	25

Aerated concrete dowel with setting tool

Suitability

- For porous concrete (aerated concrete)

Features

- Time-saving fixing system
- Cutting into the building material guarantees expansion-free anchoring
- Use in electrical operations thanks to non-conductive plastic
- Solid edge prevents slide-in in the drilled hole and ensures exact screw depth
- Includes reusable setting tool



Art. no.	Ø x length	screw-Ø	depth	g	PrU	PU
794040	10 x 50	4,0 - 6,0	60	4,800	100	50



Universal metal dowel

Suitability

- Concrete, solid brick, porous concrete, limitations for perforated bricks and hollow concrete blocks

Features

- Perfect screw guidance thanks to ribbed internal geometry
- Fire-proof pipe fixing according to technical guidelines for gas pipe installation (TRGI 3.3.7.2.)
- Dowel can be driven into porous concrete G2 and G4 without pre-drilling.



Art. no.	Ø x length	screw-Ø	depth	g	PrU	PU
794050	6 x 32	5,0 - 6,0	40	2,390	100	200
794052	8 x 60	6,0 - 8,0	70	4,790	100	100

Plasterboard dowel with setting tool

Suitability

- Plasterboard, limitations for full plasterboard and porous concrete

Features

- Time-saving fixing system with dowel and setting tool
- Perfect insertion thanks to streamlined dowel tip
- Cutting into the building material guarantees optimum anchoring
- Use in electrical operations thanks to non-conductive plastic
- Includes reusable setting tool



Art. no.	length	screw-Ø	depth	g	PrU	PU
794070	24	4,0 - 6,0	35/80	1,520	100	50

Spring toggle

Suitability

- Plasterboard and gypsum fibreboard, chipboard, fibre cement board, cavity brick covers, hollow body covers

Features

- Special metal cavity anchor
- The side opens in any position in the hole using a spring mechanism
- Long threaded rod for a larger wall thickness
- Execution: Threaded rod with washer and hexagonal nut

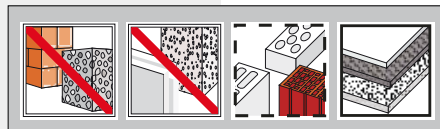
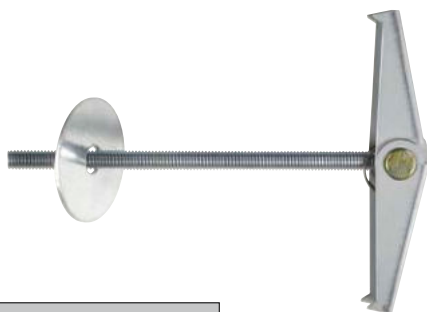

Art. no.	Ø x length	bore hole-Ø	min/max	g	PrU	PU
794060	4 x 100	14	35/80	17,240	100	25
794062	5 x 100	16	45/80	33,700	100	20

Concrete	
Natural stone	
Full bricks	
Porous concrete (aerated concrete)	
Full plasterboard panels	
Perforated bricks	
Hollow concrete blocks	
Plasterboard panels	
Boards/panels	



Tool cases



Classification for tool cases | Specifications

Legend



ABS rigid case



with lock (TSA)



temperature range for use



maximum load



with combination lock



Trolley



with document compartment



flight-suitable



with lock



air and water-tight

ABS

- Surrounding impact edge protection
- High quality metal locks, lockable
- Stable and hardened aluminium frame
- Ergonomic handle
- 3 metal hinges
- Including carrying strap

220028 Tool case „Start up S“ 460 x 180 x 310 mm



220031 Tool case „Start up Profi“ 470 x 200 x 360 mm



220023 Trolley „Start up Profi“ 470 x 200 x 360 mm



HDPEfly

- Flight-suitable and break-proof
- Extreme durability thanks to HDPE shell with soft-touch look
- Corners additionally reinforced with aluminium
- Extra wide surrounding impact edge protection
- Locking, extra-long trolley system
- Ball-bearing mounted easy running castors
- High quality metal die cast locks, lockable
- Additional combination lock
- Extremely stable and specially hardened aluminium frame
- 3 riveted metal hinges
- Particularly stable lid holder
- Screw-fitted handle and locks

220248 Trolley flight-suitable HDPE 470 x 220 x 360 mm



ABS+

- Extra wide surrounding impact edge protection
- High quality metal locks, lockable
- Extra stable and hardened aluminium frame
- 3 metal hinges
- Particularly stable lid holder

220076 Tool case „Pendant“ 460 x 180 x 310 mm



220068 Tool case „Omega“ 460 x 180 x 310 mm



220038 Tool case „Aktion“ 460 x 160 x 310 mm



220042 Tool case „Omega Max“ 470 x 200 x 360 mm



220048 Tool case „Omega Trolley“ 470 x 220 x 360 mm



PPsafe

- Extremely durable polypropylene
- Flight-suitable and break-proof
- Impact and kick-proof
- Ergonomic carry handle
- Handle can be pulled out to use as a trolley
- Can be used in temperature ranges of -33°C to +90°C
- Can be stacked

220311 Installation case „Extreme“ 581 x 455 x 381 mm



220299 Tool case trolley „Extreme“ 517 x 277 x 217 mm



Nylonbags

HAUPA "ToolPouch"

7 pockets to keep your tools handy with hammerloop and tapeholder belt loop with strong snap-button for easy attachment to belt. Material: extra strong 600D polyester, colour: black/green.



Art. no.	width	depth	height	kg	PU
220103	150	30	260	0,102	1

HAUPA "ToolBelt"

8 compartments for your tools, reinforced main compartment, steel rivets for high reliable quality. Big front compartment for nails or measurement tape, hammer sleeve, fits up to 135 cm hips, material: extra strong 600D polyester, colour: black/green.



Art. no.	width	depth	height	kg	PU
220105	200	100	300	0,326	1

Belts and jackets

Tool belt

10 compartments to organize your tools, hammer sleeve and tapeholder belt loop for easy attachment to belt, materials: extra strong 600D polyester, colour: black/green



Art. no.	width	depth	height	kg	PU
220224	880	30	280	0,350	1

Backpacks

HAUPA "Backpack"

Tool backpack, 3 compartments can be hinged upwards to the ground, front: without further inner compartments, middle: compartments for tools, rear: compartments with pockets and flaps for tools or notebook + accessoires, padded shoulder straps, lap belt, removable pad for working in a kneeling or sitting position, water and dirt resistant, material: extra strong 1680D polyester, colour: black with green stitching.



Art. no.	width	depth	height	kg	PU
220265	440	220	500	1,990	1

Jackets

HAUPA "Tool Jacket", empty

Tool jacket for quick access to your tools. Quick assembly with strong zip, inside and outside pockets, particularly suitable for use in hot temperatures. Colour: green, black, width 500 mm, height 580 mm. Non-slip shoulder belt, breathable inside net, 2 document holders at back, 5 screwdriver pockets (with rubber adjustment), 1 pen pocket, 1 mobile phone pocket (Velcro®), 1 shear pocket (with rubber adjustment), 2 pliers pockets (pushbutton fastener), 1 voltage detector pocket (Velcro®), 1 pocket for small parts (Velcro®), hammer loop.



Art. no.	width	height	kg	PU
220053	500	580	0,764	1

haupa®

... convincing solutions

HAUPA "ToolBag"

Tool bag with inner and outer tool compartments, rubber-reinforced base. Waterproof and dirt resistant, double cross-seam for heavy loads, removable shoulder strap, adjustable, 10 compartments outside (various sizes), 10 compartments inside (various sizes), belt for spirit level (outside), material: extra strong 600D polyester, colour: black/green.



Art. no.	width	depth	height	kg	PU
220061 *	320	190	280	1,507	1

HAUPA "ToolBag XL"

Tool bag XL with inner and outer tool compartments, rubber-reinforced base. **Features:** waterproof and dirt resistant, rubber-reinforced base, double cross-seam for heavy loads, removable shoulder strap, adjustable, 10 compartments inside/outside (various sizes), belt for spirit level (outside), material: extra strong 600D polyester, colour: black/green.



XL

Art. no.	width	depth	height	kg	PU
220366	420	220	310	2,000	1

HAUPA "BigBox"

very big box look alike Tool bag, easy approach to the tools, inside and outside compartments for tools, reinforced handles, material: extra strong 600D polyester, colour: black/green.



Art. no.	width	depth	height	kg	PU
220095	410	240	320	1,937	1

HAUPA "ProBag"



Tool bag with compartments inside and out, base shell made from plastic, dual seat seaming for high loads, removable shoulder strap, adjustable, 4 outer pockets (in various sizes), holder for insulation tape, 2 large internal compartments, suitable, for example, for DIN A4 folders or 15" laptops plus various compartments (in various sizes), straps for spirit level (outside), material: extremely strong **1680D polyester**, water and dirt resistant, colour: black/green.



Art. no.	width	depth	height	kg	PU
220368	420	300	430	2,500	1

Service bags

“Supply“ service bag

Document pocket, pockets for tools and measuring devices, bag for small parts, large pockets, rubber rings, separate main compartment (padded) for laptop and documents, can be divided using the removable wall section. Notebook pocket up to 15". Colour: black/green.

Features:

- Ergonomic handle
- Adjustable carrying strap with shoulder pad
- Business card pocket for identification purposes
- 2 large side zipped pockets (one of which can be opened fully and has inserts)
- 2 large folding side pockets, can be removed individually, one of which as a small pocket on the front
- Polytex straps for transport securing



Art. no.	width	depth	height	kg	PU
220292	510	220	335	3,000	1

HAUPA „Squarebag“

Tool bag made of 600D Polyester

- compact design and low weight
- with inner and outer tool compartments
- rubber-reinforced base as protection against dirt and moisture
- double cross-seam for heavy loads
- carrier bar of metal, for high wearing comfort
- removeable carrying strap, padded
- additional pockets of polyester with hook of metal and velcro fastening
- Material: extra strong 600D Polyester, water resistant and dirt-repellent
- colour: green, black



Art. no.	width	depth	height	kg	PU
220703	260	260	230	1,580	1

HAUPA „ToolContainer“

Tool bag made of 600D Polyester

- open spacious main compartment with carrier bar of metal and anti-slip grip
- big removeable protective cover made of polyester, with velcro fastening
- outside: 7 open storage bags and 3 bags with velcro fastening
- inside: 4 open storage bags, 2 buffering belts made of polyester and 2 holder of metal for measuring tapes
- adjustable, removeable shoulder strap, padded
- removeable belt pouch with 4 compartments to organize tools



Art. Nr.	width	depth	height	kg	PU
220704	510	320	250	3,080	1

haupa®

... convincing solutions

HAUPA GmbH & Co. KG, Koenigstr. 165-169, 42853 Remscheid, Phone: +49 (0)2191 8418-0, Fax: +49 (0)2191 8418-840, sales@haupa.com

Tool sets

Tool wallets

of black linen, with leather strap fastening



Art. no.	width	depth	kg	PU
220006	600	310	0,452	1

Tool sets 1000 V

VDE/GS - Tool wallets "Rebell"

in red coloured wallet



Art. no.	width	depth	height	kg	PU
220016	300	50	230	0,814	1

Tool holder

Tool holder for construction buckets

Tool bag for hanging up/covering in a commercially available 10L bucket, 30 exterior pockets/compartments, 14 inner pockets/compartments, 1 hammer loop, 1 loop with carabiner, stain-resistant, double cross-seam stitching for high load capacity, material: **extra strong 1680D polyester**, colour: black, green.
Supplied without buckets!



Art. no.	width	depth	height	kg	PU
220313	460	40	280	0,700	1

Nylonbags

HAUPA "ToolPouch"

7 pockets to keep your tools handy with hammerloop and tapeholder belt loop with strong snap-button for easy attachment to belt. Material: extra strong 600D polyester, colour: black/green.

Content:

- 2C combination pliers
- 2C electricians' screwdriver
- 2C cross slotted screwdriver PH
- Cable stripper, manual
- VDE/GS voltage tester



Art. no.	set	empty	kg	PU
220506	5-pieces	220103	0,789	1

HAUPA "ToolBelt Standard"

8 compartments for your tools, reinforced main compartment, steel rivets for high reliable quality. Big front compartment for nails or measurement tape, hammer sleeve, fits up to 135 cm hips. Material: extra strong 600D polyester, colour: green, black

Content:

- 2C cross slotted screwdrivers PH, size 1 and 2
- 2C electrician's screwdriver
- 2C combination pliers 200 mm
- 2C side cutters 160 mm
- Engineers' hammer, 300 g
- Cable stripping knife, 1-piece
- Measuring tape, 3 m



Art. no.	set	empty	kg	PU
220213	8-pieces	220105	2,222	1

Tool bag 1000 V

HAUPA „ToolBelt VDE“ 1000 V

8 compartments for your tools, reinforced main compartment, steel rivets for high reliable quality. Big front compartment for nails or measurement tape, hammer sleeve, fits up to 135 cm hips, material: extra strong 600D polyester, colour: black/green.

Content:

- 2C combination pliers, 200 mm
- 2C side cutters, 160 mm
- 2C electrician's screwdriver
- 2C cross slotted screwdrivers PH, size 1 and 2
- Voltage tester "Basic"
- Cable knife, 1-piece



Art. no.	set	empty	kg	PU
220211 *	7-pieces	220105	1,723	1

Belts and jackets

Tool belt „Basic“

10 compartments to organize your tools, hammer sleeve and tapeholder belt loop for easy attachment to belt, materials: extra strong 600D polyester, colour: black/green.

Content:

- 2C-VDE-Electricians' screwdriver 5,5x125 mm
- 2C-VDE-Electricians' screwdriver 3x100 mm
- 2C-VDE-Cross slotted screwdrivers PH 2
- Measuring tape 3 m
- 2C-Combination pliers 180 mm
- 2C-Side cutters 160 mm
- VDE/GS Voltage tester 125-250 V
- Utility metal knife
- Wire stripper, hooked blade, 8-28 mm Ø
- Cable cutter with stripping function



Art. no.	set	empty	kg	PU
220280	10-pieces	220224	2,120	1

Tool belts 1000 V

Tool belt "VDE Plus" 1000 V

10 compartments to organize your tools, hammer sleeve and tapeholder belt loop for easy attachment to belt, materials: extra strong 600D polyester, colour: black/green

Content:

- 2C-VDE-Cable cutters 200 mm
- 2C-VDE-Side cutters 165 mm
- 2C-VDE-Combination pliers 185 mm
- 2C-Replaceable blade system „Vario“ 1000 V, 10 pcs.
- VDE-Cable cutter straight blade, 50 mm
- Voltage tester „Profi“ 12-690 V
- Test Pen „Basic“



Art. no.	set	empty	kg	PU
220281 *	16-pieces	220224	2,740	1

Tool belt "VDE" 1000 V

10 compartments to organize your tools, hammer sleeve and tapeholder belt loop for easy attachment to belt, materials: extra strong 600D polyester, colour: black/green

Content:

- 2C-VDE-Side cutters 165 mm
- 2C-VDE-Cable cutters 160 mm
- 2C-VDE-Combination pliers 185 mm
- 2C-VDE-Electricians' screwdriver 5,5x125 mm
- 2C-VDE-Cross slotted screwdrivers PH 2
- 2C-VDE-Electricians' screwdriver 3x100 mm
- VDE-Cable cutter straight blade, 50 mm
- Test Pen „Basic“



Art. no.	set	empty	kg	PU
220282	8-pieces	220224	2,020	1

haupa[®]

... convincing solutions

BackpackPro "Basic 1000 V"

Tool backpack for the professional user, 3 compartments can be hinged upwards to the ground, front: without further inner compartments, middle: compartments for tools, rear: compartments with pockets and flaps for tools or notebook + accessoires, padded shoulder straps, lap belt, removable pad for working in a kneeling or sitting position, comes complete with 11 tools, water and dirt resistant, material: **extra strong 1680D polyester**, colour: black with green stitching. BackpackPro 220265.

Content:

- Screwdrivers set 1000 V, Phillips, 6 pieces
Content: Electricians' screwdriver 1000 V
2.5 x 75 mm / 4 x 100 mm / 5.5 x 125 mm / 6.5 x 150 mm,
Cross slotted screwdrivers 1000 V, Phillips size 1 and 2
- Combination pliers 1000 V, 180 mm
- Side cutters 1000 V, 160 mm
- Long chain nose pliers 1000 V, straight, 200 mm
- Cable cutters 1000 V, 200 mm
- VDE/GS-Voltage testers, 120 - 250 V, loose



Art. no.	set	empty	kg	PU
221277	11-pieces	220265	3,710	1

BackpackPro "Start 1000 V"

Tool backpack for the trainee, 3 compartments can be hinged upwards to the ground, front: without further inner compartments, middle: compartments for tools, rear: compartments with pockets and flaps for tools or notebook + accessoires, padded shoulder straps, lap belt, removable pad for working in a kneeling or sitting position, comes complete with 20 tools, water and dirt resistant, material: **extra strong 1680D polyester**, colour: black with green stitching. BackpackPro 220265.

Content:

- Screwdrivers set 1000 V, Phillips, 6 pieces
Content: Electricians' screwdriver 1000 V
2.5 x 75 mm / 4 x 100 mm / 5.5 x 125 mm / 6.5 x 150 mm,
Cross slotted screwdrivers 1000 V, Phillips size 1 and 2
- Combination pliers 1000 V, 180 mm²
- Side cutters 1000 V, 160 mm²
- Long chain nose pliers 1000 V, straight, 200 mm²
- VDE/GS-Voltage testers, 120 - 250 V, loose
- Cable stripping knife "Safety", without hook blade, 8 - 28 mm²
- Industrial ring brush, size 4
- Plaster cups
- Paint scrapers 40 mm
- Stone chisels, flat oval shank, 28 x 250 mm
- Electricians' chisels, 10 x 250 mm
- Engineers' hammer 300 g
- Sledge hammer 1000 g
- Junior hacksaw, with metal blade
- Super wire stripper "Basic", 0.5 - 4 mm²



Art. no.	set	empty	kg	PU
221280	20-pieces	220265	5,200	1

BackpackPro “Basic plus 1000 V”

Tool backpack for the professional user, 3 compartments can be hinged upwards to the ground, front: without further inner compartments, middle: compartments for tools, rear: compartments with pockets and flaps for tools or notebook + accessoires, padded shoulder straps, lap belt, removable pad for working in a kneeling or sitting position, comes complete with 19 tools, water and dirt resistant, material: **extra strong 1680D polyester**, colour: black with green stitching. BackpackPro 220265.

Content:

- Screwdrivers set 1000 V, Phillips, 6 pieces
Content: Electricians' screwdriver 1000 V 2.5 x 75 mm / 4 x 100 mm / 5.5 x 125 mm / 6.5 x 150 mm, Cross slotted screwdrivers 1000 V, Phillips size 1 and 2
- Combination pliers 1000 V, 180 mm²
- Side cutters 1000 V, 160 mm²
- Long chain nose pliers 1000 V, bent, 200 mm²
- Voltage tester “TestPen Profi”, 12 – 1000 V
- Cable stripping knife “Basic”, with hook blade, 8 – 28 mm²
- Super wire stripper “Basic”, 0.5 – 4 mm²
- Industrial ring brush, size 4
- Paint scrapers 40 mm
- Electricians' chisels 10 x 250 mm
- Engineers' hammer 300 g
- Cable stripping knives, with wooden scales
- Hand saw “PUK”, with fixed handle
- Measuring tapes 3 m



Art. no.	set	empty	kg	PU
221278	19-pieces	220265	4,650	1

BackpackPro “Operator 1000 V”

Tool backpack for the professional user, 3 compartments can be hinged upwards to the ground, front: without further inner compartments, middle: compartments for tools, rear: compartments with pockets and flaps for tools or notebook + accessoires, padded shoulder straps, lap belt, removable pad for working in a kneeling or sitting position, comes complete with 22 tools, water and dirt resistant, material: **extra strong 1680D polyester**, colour: black with green stitching. BackpackPro 220265.

Content:

- “Vario” 1000 V replaceable blade system, Phillips, 10 pcs.
Content: 2C exchangeable handle, screw cap, replaceable blade - slotted blade 0.4 x 2.5 / 0.5 x 3.0 / 0.8 x 4.0 / PH1 / PH2, PZ/FL 2, switch cabinet key - square 1, double-bit
- Combination pliers 1000 V, 180 mm²
- Side cutters 1000 V, 160 mm²
- Long chain nose pliers 1000 V, straight, 200 mm²
- Cable cutters 1000 V, 200 mm
- Water pump pliers 1000 V, 240 mm
- “Multi Check II” - digital high-capacity multimeter
- Voltage tester “Profi LEDplus III” 6 – 1000 V
- Automatic wire stripper “Super Plus” 0.2 – 6 mm²
- Cable knife 1000 V, with straight blade
- Spanners for switch-cabinets, “HUPkey”
- Mini working light “HUPlight4”, LED 4 Watt
- Measuring tapes 3 m

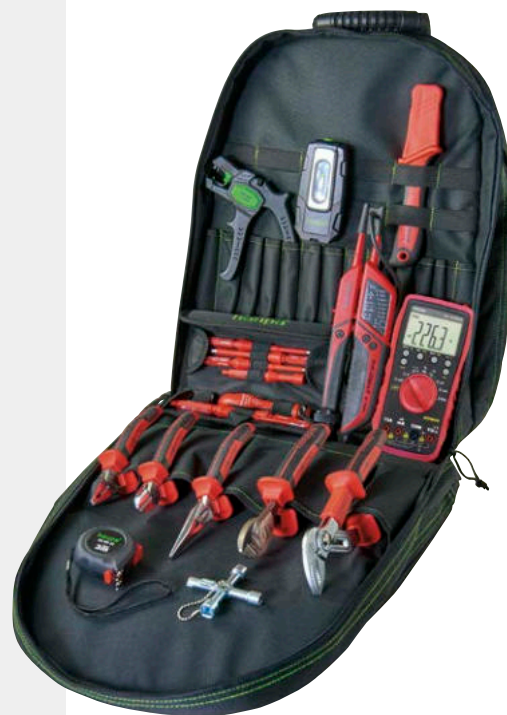

Art. no.	set	empty	kg	PU
221279	22-pieces	220265	5,570	1

HAUPA "Tool Jacket"

Tool jacket for quick access to your tools. Tool jacket for fitters including 10 tools. Quick assembly with strong zip, inside and outside pockets, particularly suitable for use in hot temperatures. Colour: green, black, width 500 mm, height 580 mm.

Non-slip shoulder belt, breathable inside net, 2 document holders at back, 5 screwdriver pockets (with rubber adjustment), 1 pen pocket, 1 mobile phone pocket (Velcro®), 1 shear pocket (with rubber adjustment), 2 pliers pockets (pushbutton fastener), 1 voltage detector pocket (Velcro®), 1 pocket for small parts (Velcro®), hammer loop.

Content:

- 2C-VDE electrician's screwdriver with PZ/FL profile
- 2C-VDE electrician's screwdrivers, 75, 10, 125 mm
- 2C cross slotted screwdriver, PH, 80 mm
- 2C electrician's scissors
- Combination pliers VDE
- Diagonal cuttter VDE
- Voltage tester "Basic"
- Engineer's hammer 300 g



Art. no.	set	empty	kg	PU
220560	10-pieces	220053	2,700	1

HAUPA "ToolBag"

Tool bag with inner and outer tool compartments, rubber-reinforced base. Comes complete with 22 tools.

Features: Waterproof and dirt resistant, rubber-reinforced base, double cross-seam for heavy loads, removable shoulder strap, adjustable, 10 compartments outside (various sizes), 10 compartments inside (various sizes), belt for spirit level (outside), material: extra strong 600D polyester, colour: black/green.

Content:

- 2C combination pliers, 200 mm
- 2C side cutters, 160 mm
- 2C telephone pliers, straight
- 2C wire stripping pliers, 160 mm
- VDE screwdriver set, 6 electrician's screwdrivers
- Voltage tester
- Wire stripper, hooked blade, 8 - 28 mm Ø
- Water brush
- Paint scraper, 40 mm
- Electrician's chisel, 10 x 250 mm
- Stone chisel, 300 mm
- Engineers' hammer, 300 g
- Sledge hammer, 1000 g
- Plaster container
- Cable knife, 1-pieces
- PUK pocket saw, fixed handle
- Carpenter's pencil



Art. no.	set	empty	kg	PU
220500	22-pieces	220061	6,350	1

Tool bag 1000 V

HAUPA "ToolBag" 1000 V

Tool bag with inner and outer tool compartments, rubber-reinforced base. Comes complete with 13 tools.

Content:

- 2C-VDE combinations pliers 185 mm
- 2C-VDE side cutters 165 mm
- 2C-VDE telephone pliers pliers, straight, 200 mm
- 2C-VDE wire stripping pliers 160 mm
- 2C-VDE-screwdriver set, 6 electrician's screwdrivers
- Spanner for switch-cabinets
- Cable knife
- Voltagetester "Basic"



Art. no.	set	empty	kg	PU
220510 *	13-pieces	220061	3,919	1

Nylonbags

HAUPA "ToolBag XL Classic"

Tool bag XL with inner and outer tool compartments, rubber-reinforced base. Comes complete with 22 tools.

Features: Waterproof and dirt resistant, rubber-reinforced base, double cross-seam for heavy loads, removable shoulder strap, adjustable, 10 compartments inside/outside (various sizes), belt for spirit level (outside), material: extra strong 600D polyester, colour: green, black. ToolBag XL 220366.

Content:

- 2C-VDE electrician's screwdrivers, 2.5 x 75, 4 x 100, 5.5 x 125, 6.5 x 150 mm
- 2C-VDE cross slotted screwdrivers PH, size 1 + 2
- 2C combination pliers, 200 mm
- 2C heavy duty side cutters, 175 mm
- 2C telephone pliers, straight, 200 mm
- 2C wire stripping pliers, 160 mm
- Voltage tester
- Wire stripper, hooked blade, 8 - 28 mm Ø
- Water brush
- Paint scraper, 40 mm
- Electrician's chisel, 10 x 250 mm
- Stone chisel, 300 mm
- Engineers' hammer, 300 g
- Sledge hammer, 1000 g
- Plaster container
- Cable knife, 1 blade
- PUK pocket saw, fixed handle
- Carpenter's pencil

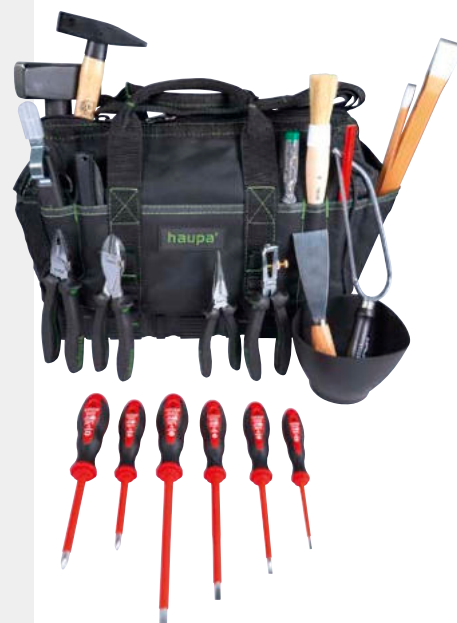

XL

Art. no.	set	empty	kg	PU
220802	22-pieces	220366	9,810	1

haupa[®]

... convincing solutions

HAUPA "ToolBag XL Go"

Tool bag XL with inner and outer tool compartments, rubber-reinforced base.

Features: Waterproof and dirt resistant, rubber-reinforced base, double cross-seam for heavy loads, removable shoulder strap, adjustable, 10 compartments inside/outside (various sizes), belt for spirit level (outside), material: extra strong 600D polyester, colour: green, black. ToolBag 220366.

Content:

- 2C-VDE combinations pliers, 185 mm
- 2C-VDE heavy duty side cutters, 170 mm
- 2C-VDE telephone pliers, straight, 200 mm
- 2C-VDE electrician's screwdriver PZ/FL 1 + 2
- 2C-VDE electrician's screwdriver 2,5 x 75, 3,5 x 100, 4 x 100, 6,5 x 150 mm
- 2C-VDE cross slotted screwdrivers PH 1 + 2
- Automatic wire stripper 0,2-6 mm²
- Switching cabinet key
- Cable stripper hooked blade, 8 - 28 mm Ø



XL

Art. no.	set	empty	kg	PU
220804 *	14-pieces	220366	4,400	1

HAUPA "ToolBag XL 1000 V"

Tool bag XL with inner and outer tool compartments, rubber-reinforced base. Comes complete with 13 tools. Material: extra strong 600D polyester, colour: black/green. ToolBag XL 220366.

Content:

- 2C-VDE combinations pliers, 185 mm
- 2V-VDE heavy duty side cutters, 170 mm
- 2C-VDE telephone pliers, straight, 200 mm
- 2C-VDE wire stripping pliers, 160 mm
- 2C-VDE electrician's screwdrivers, 2,5 x 75, 4 x 100, 5,5 x 125, 6,5 x 150 mm
- 2C-VDE cross slotted screwdrivers PH, size 1 + 2
- Spanners for switch-cabinets
- Cable knife
- Voltage tester „Basic“



1000 V IEC 60900



XL

Art. no.	set	empty	kg	PU
220800	13-pieces	220366	4,600	1

HAUPA "TrendBox Plus"

Tool bag for professional use. With inside and outside pockets, easy access to the tools, inside and outside compartments for tools, reinforced handles, material: extra strong 600D polyester, colour: green, black. Big box 220095.

Content:

- 2C-VDE electrician's screwdrivers, 2.5 x 75, 4 x 100, 5.5 x 125, 6.5 x 150 mm
- 2-VDE cross slotted screwdrivers PH, size 1 + 2
- 2C combination pliers, 180 mm
- 2C telephone pliers, 200 mm
- 2C side cutters, 160 mm
- 2C water pump pliers, 240 mm
- 2C wire stripping pliers, 160 mm
- Bit-Box, 17-pieces
- Voltage tester „Basic“
- Allen keys set, 7-pieces
- Adjustable single-head wrench
- Chalk - blue
- Impact cord roller
- Carpenters' pencil
- Engineers' hammer 300 g
- Cable stripping knife
- Junior hacksaw, heavy 150 mm
- Cable cutters 160 mm insulatet
- Combi-Drillbox
- Spanners for switch-cabinets
- Folding rule, fibre glass, 2 m



Art. no.	set	empty	kg	PU
220556 *	25-pieces	220095	6,430	1

HAUPA "TrendBox"

Tool bag for professional use. With inside and outside pockets, including 20 tools, easy approach to the tools, inside and outside compartments for tools, reinforced handles, material: extra strong 600D polyester, colour: green, black.

Content:

- 2C combination pliers, 200 mm
- 2C side cutters, 160 mm
- 2C telephon pliers, straight, 200 mm
- 2C water pump pliers, 240 mm
- VDE screwdrivers set, 6 electricians' screwdrivers
- Cable ties, 292 x 3,6 mm
- Cabinet spirit level
- Filling knife, 40 mm
- Electrician's chisel, 10 x 250 mm
- Voltage tester, VDE/GS
- Fitter's hammer, 300 g
- Universal stripper
- Measuring tape, 3 m
- PUK pocket saw, fixed handle
- Carpenters pencil



Art. no.	set	empty	kg	PU
220550	20-pieces	220095	5,540	1

HAUPA "ProBag Max"

Tool bag with compartments inside and out, base shell made from plastic, dual seat seaming for high loads, removable shoulder strap, adjustable, 4 outer pockets (in various sizes), holder for insulation tape, 2 large internal compartments, suitable, for example, for DIN A4 folders or 15" laptops plus various compartments (in various sizes), straps for spirit level (outside), material: extremely strong 1680D polyester, water and dirt resistant, colour: black/green. ProBag 220368.

Content:

- 2C-VDE combinations pliers, 185 mm
- 2C-VDE heavy duty side cutters, 170 mm
- 2C-VDE telephone pliers, straight, 200 mm
- 2C-VDE electrician's screwdriver 2,5 x 75, 3,5 x 100, 4 x 100, 5,5 x 125, 6,5 x 150 mm
- 2C-VDE cross slotted screwdrivers PH 1 + 2
- 2C-VDE electrician's screwdriver PZ/FL 1 + 2
- Cable cutter 160 mm
- ESD electronic pliers 110 mm
- Allround soft-grip scissor 150 mm
- Automatic cable stripper 0,08-6,0 mm²
- LED „Headlight“ headlamp
- VDE cable knife 50 mm
- Utility knives „EXTRA“ with spare blades 19 mm
- Voltage tester „Profi LCD Plus“ 12-1.000 V
- Spanners for switch-cabinets
- Measuring tapes 3 m
- Adjustable single-head wrench 24 mm
- Bit set, 33 pieces
- Industrial cleaning wipes
- Cable ties black UV resistant, 203x4,6 mm
- Cable ties natural 203x4,6 mm
- HAUPA „Flex Bag“



Art. no.	set	empty	kg	PU
220810	29-pieces	220368	9,180	1

HAUPA "ProBag Start VDE"

Tool bag with compartments inside and out, base shell made from plastic, dual seat seaming for high loads, removable shoulder strap, adjustable, 4 outer pockets (in various sizes), holder for insulation tape, 2 large internal compartments, suitable, for example, for DIN A4 folders or 15" laptops plus various compartments (in various sizes), straps for spirit level (outside), material: extremely strong 1680D polyester, water and dirt resistant, colour: green/black. ProBag 220368.

Content:

- 2C-VDE electrician's screwdrivers, 2,5 x 75, 4 x 100, 5,5 x 125, 6,5 x 150 mm
- 2C-VDE cross slotted screwdrivers PH, size 1 + 2
- 2C-VDE telephone pliers, 200 mm
- 2C-VDE combination pliers, 180 mm
- 2C-VDE heavy duty side cutters, 170 mm
- 2C-VDE wire stripping pliers, 160 mm
- Cable knife, 1 blade
- Electricians' chisel, 10 x 250 mm
- VDE/GS Voltage tester - blade 50 mm
- PUK pocket saw, fixed handle
- Brush
- Stone chisel, 300 mm
- Engineers' hammer, 300 g
- Double-face sledge hammer, 1000 g
- Spatula, 40 mm
- Plaster container



Art. no.	set	empty	kg	PU
220814	20-pieces	220368	9,180	1

HAUPA "ProBag Go 1000 V"

Tool bag with compartments inside and out, base shell made from plastic, dual seat seaming for high loads, removable shoulder strap, adjustable, 4 outer pockets (in various sizes), holder for insulation tape, 2 large internal compartments, suitable, for example, for DIN A4 folders or 15" laptops plus various compartments (in various sizes), straps for spirit level (outside), material: extremely strong 1680D polyester, water and dirt resistant, colour: green/black. ProBag 220368.

Content:

- 2C-VDE combinations pliers, 185 mm
- 2C-VDE heavy duty side cutters, 170 mm
- 2C-VDE telephone pliers, straight, 200 mm
- 2C-VDE electrician's screwdriver PZ/FL 1 + 2
- 2C-VDE electrician's screwdriver 2,5x75, 3,5x100, 4x100, 6,5x150 mm
- 2C-VDE cross slotted screwdrivers PH 1 + 2
- Automatic wire stripper 0,2-6 mm²
- Switching cabinet key
- Cable stripper hooked blade, 8 - 28 mm Ø



Art. no.	set	empty	kg	PU
220812 *	14-pieces	220368	9,180	1

"HUPsmartHome" service bag

Document pocket, pockets for tools and measuring devices, bag for small parts, large pockets, rubber rings, separate main compartment (padded) for laptop and documents, can be divided using the removable wall section. Notebook pocket up to 15". Colour: black/green.

Content:

- Combination pliers 180 mm
- Side cutters 160 mm
- Long chain nose pliers 45°, 160 mm
- Screwdrivers set „HUPslim“ 1000 V PH
- Screwdrivers set „HUPslim“ 1000 V PZ/FL
- Stripper „Allrounder“ 4 - 15 mm²
- Cable stripper „Top Coax Plus“ 4,8 - 7,5 mm²
- Perlon fish tapes, 15 m x 3 mm
- Spanners for switch-cabinets, „HUPkey“
- Water pump pliers 170 mm
- Folding rules
- Aluminium spirit levels 400 mm
- Carpenters' pencils
- Engineers' hammer 300 g
- Electricians' chisels 10 x 250 mm
- Voltage tester „Basic +“
- Crimping pliers for modular plugs
- Cable stripping knives
- Sensor Tool LSA
- Crimping pliers HUPsquare10 0,08 - 10 mm²
- Hand saw „PUK“
- Ratchet screwdriver set „FlexBag“
- ESD Electronic side cutter without cutting-facet



Art. no.	set	empty	kg	PU
220805	23-pieces	220292	7,550	1

haupa[®]

... convincing solutions

“Supply Max“ service bag

Document pocket, pockets for tools and measuring devices, bag for small parts, large pockets, rubber rings, separate main compartment (padded) for laptop and documents, can be divided using the removable wall section. Notebook pocket up to 15". Colour: black/green.

Contents:

- 2K-VDE electrician's screwdriver 2.5 x 75, 3.5 x 100, 4 x 100, 5.5 x 125, 6.5 x 150 mm
- 2K-VDE screwdriver PH 1 + 2
- 2K-VDE screwdriver PZ/FL 1 + 2
- Cable cutter 160 mm dip-insulated
- VDE side cutter 165 mm
- VDE combination pliers 185 mm
- VDE-long chain nose pliers straight
- Electronic side cutter 110 mm
- Electrician's scissors, stainless steel 150 mm
- Switching cabinet key
- Adjustable single-head wrench 24 mm
- Bit set, 33 pieces
- All-purpose industrial cleaning cloths
- Cable-ties, black, UV-resistant 203 x 4.6 mm
- Cable-ties, natural, 203 x 4.6 mm
- Automatic strippers 0.08 - 6.0 mm²
- LED head lamp 75 lm
- VDE cable knife with replaceable blades 50 mm
- Cutting knife "EXTRA" with replacement blades 19 mm
- Voltage tester "Profi LCD Plus" 12 - 1,000 V
- Electrical insulating tape VDE 15 mm x 10 m, Rainbow pack, 263820, 10 colours
- Measuring tape 3 m
- HAUPA "Flex Bag"
- Set X-CrimpPlus



Art. no.	set	empty	kg	PU
220293	30-pieces	220292	6,350	1

“Supply Plus“ service bag

Document pocket, pockets for tools and measuring devices, bag for small parts, large pockets, rubber rings, separate main compartment (padded) for laptop and documents, can be divided using the removable wall section. Notebook pocket up to 15". Colour: black/green.

Contents:

- 2K-VDE electrician's screwdriver 2.5 x 75, 3.5 x 100, 4 x 100, 5.5 x 125, 6.5 x 150 mm
- 2K-VDE screwdriver PH 1 + 2
- 2K-VDE screwdriver PZ/FL 1 + 2
- 2K-VDE-long chain nose pliers straight
- Cable cutter 160 mm dip-insulated
- VDE side cutter 165 mm
- VDE combination pliers 185 mm
- Electronic side cutter 110 mm
- Electrician's scissors, stainless steel 150 mm
- Cutting knife "EXTRA" with replacement blades 19 mm
- Adjustable single-head wrench 24 mm
- All-purpose industrial cleaning cloths
- Cable-ties, black, UV-resistant 203 x 4.6 mm
- Electrical insulating tape VDE 15 mm x 10 m, Rainbow pack, 263820, 10 colours
- Voltage tester "Basic" 6 - 400 V
- Switching cabinet key
- Measuring tape 3 m
- LED head lamp 75 lm



Art. no.	set	empty	kg	PU
220294	* 24-pieces	220292	6,350	1

Service bags

“Supply Basic“ service bag

Document pocket, pockets for tools and measuring devices, bag for small parts, large pockets, rubber rings, separate main compartment (padded) for laptop and documents, can be divided using the removable wall section. Notebook pocket up to 15". Colour: black/green.

Contents:

- 2K-VDE electrician's screwdriver 2.5 x 75, 4 x 100, 5.5 x 125, 6.5 x 150 mm
- 2K-VDE screwdriver PH 1 + 2
- 2K-VDE screwdriver PZ/FL 1 + 2
- VDE side cutter 165 mm
- VDE combination pliers 185 mm
- Cable cutter 160 mm dip-insulated
- Electrical insulating tape VDE 15 mm x 10 m, Rainbow pack, 263820, 10 colors
- Measuring tape 3 m



Art. no.	set	empty	kg	PU
220298	14-pieces	220292	6,350	1

HAUPA „SquareBag Basic 1000 V“

Tool bag made of 600D Polyester, with inner and outer tool compartments, with padded carrying strap, rubber-reinforced base, double cross-seam for heavy loads. ToolBag 220703.

Content:

- Automatic wire stripper “Super Plus“ 0,2 - 6 mm²
- 2C-VDE electricians' screwdrivers HUPslim 4 x 100 mm, blade thickness 0,8 and 1,0 mm
- 2C-VDE electricians' screwdrivers HUPslim PH, size 1 + 2
- 2C-VDE electricians' screwdrivers HUPslim PZ/FL, size 2
- VDE telephone pliers 45°, 200 mm
- VDE side cutters 160 mm
- VDE combination pliers 180 mm
- Measuring tape 3 m
- PU textile gloves, size 9



Art. no.	set	empty	kg	PU
220706	11-pieces	220703	3,040	1

HAUPA „ToolContainer Work“

Tool bag made of 600D Polyester, with inner and outer tool compartments, with carrier bar of metal and anti-slip grip, removeable protective cover made of polyester, removeable belt pouch, ToolBag 220704.

Content:

- VDE Screwdriver set HUPslim 1000 V, Phillips, 6 pcs.
Content: 2C-VDE electricians' screwdrivers HUPslim 3,5 x 0,6 x 100 mm | 4 x 0,8 x 100 mm | 5,5 x 1,0 x 125 mm | 6,5 x 1,2 x 150 mm,
- 1 VDE-Cross slotted screwdrivers HUPslim PH, size 1 + 2
- 2C-VDE electricians' screwdrivers HUPslim 4 x 1,0 x 100 mm
- VDE screwdrivers HUPslim PZ/FL 1 + 2
- VDE combination pliers 180 mm
- VDE side cutters 160 mm
- VDE long chain nose pliers 200 mm
- VDE cable cutter 160 mm
- Stripper “Allrounder“ 4 - 15 mm²
- Stripper “Top Coax Plus“ 4,8 - 7,5 mm²
- Perlon fish tapes, 15 m x 3 mm
- 100 x connecting clamps PC, 5-pole, 1 - 2,5 mm²
- PU textile gloves Level 5, size 10
- Spanners for switch-cabinet “HUPkey“
- LED “Pen Torch“ • Folding rules 2 m
- Aluminium spirit levels 400 mm
- Carpenters' pencils • Water brushes
- Plaster cups • Paint scrapers 50 mm
- Stone chisels 32 x 300 mm
- Engineers' hammer 300 g • Sledge hammer 1000 g
- Utility metal knives
- Hacksaw 300 mm
- SDS-hammer drill sets
- Contact spray HUPwetBlock
- Industrial cleaning wipes
- Electricians' chisels 10 x 250 mm

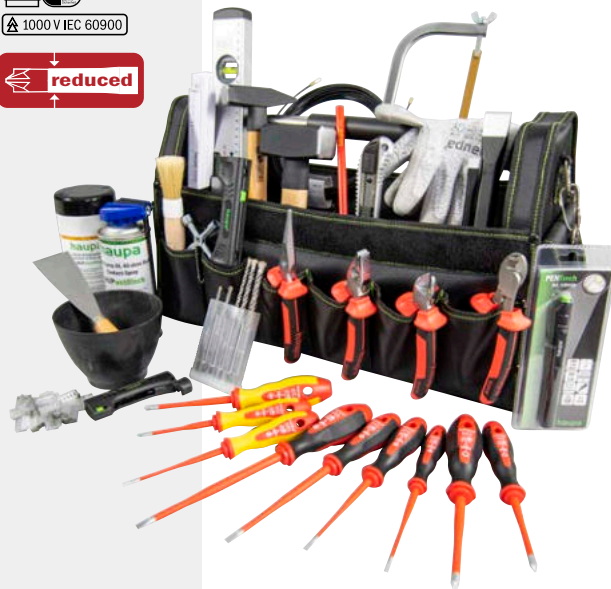

Art. no.	set	empty	kg	PU
220705	29-pieces	220704	9,800	1

haupa®

... convincing solutions

VDE security set 1000 V

Bag of imitation leather, for working under tension up to 1000 V. 10-pieces

Content:

- 2C-VDE electricians screwdrivers 2,5 x 75, 4 x 100, 5,5 x 125, 6,5 x 150 mm
- 2C-VDE cross slotted screwdrivers PZ, size 1 + 2
- 2C-VDE combination pliers VDE 185 mm
- 2C-VDE side cutters 185 mm
- Voltage tester "Basic"
- Cable stripping knife, 35 mm



Art. Nr.	set	empty	kg	PU
220014	10-pieces	220004	1,688	1

VDE/GS - Tool sets 1000 V

in red coloured plastic wallet, made from artificial leather, 11-pieces.

Content:

- VDE combination pliers 185 mm
- VDE round nose pliers 160 mm
- VDE side cutters 165 mm
- VDE wire stripping pliers 160 mm
- 2C-VDE electricians screwdrivers 75, 100, 125, 150 mm
- 2C-VDE cross slotted screwdrivers PZ, size 1
- 2C-VDE socket wrench 7 mm
- VDE/GS voltage tester



Art. Nr.	set	Breite	Höhe	Tiefe	kg	PU
220130	11-pieces	300	230	50	2,216	1

Tool case "Tradition" and "Fan"

made of black leather, with 2 inside loops and 2 snap-locks.

220022: Tradition
220024: Fan



Art. no.	width	depth	height	kg	PU
220022	340	110	170	0,821	1
220024	370	115	255	1,669	1

Tool case "Favorit - Admiral - Profi"

made of black leather, with galvanized floor-onset of sheet-metal collapsable front, with locks, side-, front-, rear-parts as well as bottom and cover reinforced, inside with tool-compartments and adjustable loops, without carrying belts.

220060: Favorit
220064: Admiral
220066: Profi



Art. no.	width	depth	height	kg	PU
220060	365	150	250	2,126	1
220064	470	145	315	2,990	1
220066	420	150	250	2,378	1

Tool case "Comet"

made of black leather, all outside edges reinforced with Alu-squares, with galvanized floor-onset of sheet-metal collapsable front, snap-fasteners riveted on side, side-loops for carrying-belts, 2 snap-locks, all 4 inside with toolcompartments and adjustable loops, without carrying belts



Art. no.	width	depth	height	kg	PU
220070	420	165	320	3,939	1

Leather tool cases

Tool case "Magister"

of signal-red leather, with many compartements for tools, empty



Art. no.	width	depth	height	kg	PU
220142	440	165	260	2,700	1

Accessories

Brass padlocks

body made from a solid brass block, hardened steel shackle, with 2 keys



Art. no.	Size	kg	PU
220110	30	0,085	1
220112	40	0,135	1

Carrying belts

with 2 spring hooks



Art. no.	kg	PU
220054	0,114	1

Leather tool cases

Tool case "Phoenix"

Tool case for electrical contractor, made of black neat's leather, with 39 tools. Case 220070.

Content:

- 2C long flat nose pliers, 160 mm
- 2C telephone pliers, 200 mm
- 2C combination pliers, 180 mm
- 2C side cutters, 160 mm
- 2C wire stripping pliers, 160 mm
- 2C water pump pliers, 240 mm
- ESD electronic side cutters, 115 mm
- ESD electronic needle nose pliers, 130 mm
- Crimping pliers multi insulated and non-insulated crimping terminals
- 2C engineers' screwdrivers 100, 125, 150 mm
- 2C electrician's screwdrivers 2.5 x 75, 4 x 125, 5 x 150, 5 x 175 mm
- 2C cross slotted screwdrivers PH, size 0, 1 and 2
- 2C cross slotted screwdrivers PZ, size 1 and 2
- Electronic screwdriverset, 7-pieces
- 2C socket wrenches, 5.5, 12, 17
- Reamer, round
- Allen key set, 8-pieces
- Adjustable wrench, 340 mm
- Cable stripper hooked blade, 8 - 28 mm Ø
- Combination snips, 190 mm
- PUK" pocket saw, fixed handle
- Electrician's chisel, 10 x 250 mm
- Folding rules, 2 m
- Light metal spirit level, 400 mm
- Bench hammer, 300 g
- Cable cutter, max. 16.9 mm
- Cutter knife, plastic
- Cable stripping knife, plastic scales
- VDE/GS voltage tester 125 - 250 V



Art. no.	set	empty	kg	PU
220156	39-pieces	220070	9,900	1

haupa[®]

... convincing solutions

Leather tool cases

Tool case "Saphir"

Tool case for electrical contractor, made of green neat's leather, with 31 tools. Case 220070.

Content:

- 2C long-nosed round pliers, 160 mm
- 2C telephone pliers, 200 mm
- 2C combination pliers, 180 mm
- 2C side cutters, 160 mm
- 2C wire stripping pliers, 160 mm
- 2C water pump pliers, 240 mm
- ESD electronic side cutters, 115 mm
- 2CE electrician's screwdrivers 2.5 x 75, 4 x 100, 4 x 125, 5 x 150 mm
- 2C engineers' screwdrivers 6 x 100, 7 x 125, 8 x 150 mm
- 2C cross slotted screwdrivers PH, size 1 and 2
- 2C cross slotted screwdrivers PZ, size 1 and 2
- Electronic screwdriverset, 7-pieces
- Socket wrenches SW 5.5, 13, 17
- Allen key set, 8-pieces
- Cable stripper hooked blade, 8 - 28 mm Ø
- Combination snips 190 mm
- „PUK“ pocket saw, fixed handle
- Bench hammer 400 g
- Folding rules 2 m
- Cable cutter max. 16.9 mm
- Cable stripping knife plastic scales
- Voltage tester VDE/GS

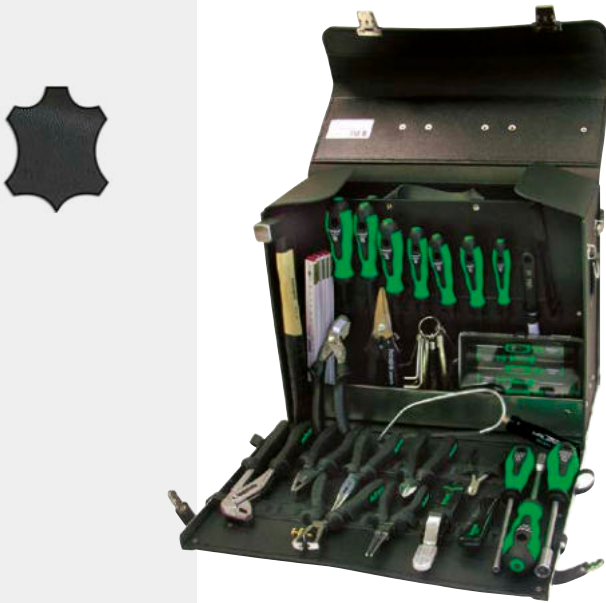

Art. no.	set	empty	kg	PU
220154	31-pieces	220070	8,150	1

Tool case "Novelle 1"

Tool case for electrical contractor, made of black neat's, leather, with 26 tools. Case 220066.

Content:

- 2C combination pliers, 180 mm
- 2C side cutters, 160 mm
- 2C heavy duty side cutters, 180 mm
- 2C telephone pliers, 200 mm
- 2C water pump pliers, 240 mm
- 2C wire stripping pliers, 160 mm
- 2C electrician's screwdrivers, 75, 125, 150 mm
- 2C engineers' screwdrivers, 100, 150 mm
- 2C cross slotted screwdrivers PH, size 1 and 2
- 2C cross slotted screwdrivers PZ, size 1 and 2
- Reamer square
- Cable stripper 0.5 - 4 Ø
- Cable stripper hooked blade, 8 - 28 mm Ø
- Painter scrapers
- Bench hammer 300 g
- Cable stripping knife plastic scales
- Combination snips 140 mm
- „PUK“pocket saw, adjustable handle
- Voltage tester "Basic"
- Voltage tester VDE/GS



Art. no.	set	empty	kg	PU
220152/1	26-pieces	220066	6,500	1

Leather tool cases

Tool case "Alpha"

Tool case made from black neat's leather, equipped with 19 tools. Case 220060.

Content:

- 2C combination pliers, 180 mm
- 2C side cutters, 160 mm
- 2C telephone pliers, 200 mm
- 2C-VDE electrician's screwdrivers, 2.5 x 75, 4 x 100, 5.5 x 125, 6.5 x 150 mm
- 2C-VDE cross slotted screwdrivers PH, size 1 and 2
- Voltage tester VDE/GS
- Wire stripping pliers, 0.5 - 4 mm²
- Cable stripper hooked blade, 8 - 28 mm Ø
- Cable knife, 1-pieces
- PUK pocket saw, fixed handle
- Electricians' chisel, 10 x 250 mm
- Stone chisel, 250 mm
- Engineers' hammer, 300 g
- Measuring Tape, 3 m
- Cabinet Level, 250 mm



Art. no.	set	empty	kg	PU
220169	19-pieces	220060	5,200	1

Tool case "Start"

Tool case for apprentices, made from black cow hide equipped with 20 tools. Case 220060.

Content:

- 2C-VDE electrician's screwdrivers, 2.5 x 75, 4 x 100, 5.5 x 125, 6.5 x 150 mm
- 2C-VDE cross slotted screwdrivers PH, size 1 and 2
- 2C telephone pliers, 200 mm
- 2C combination pliers, 180 mm
- 2C side cutters, 160 mm
- 2C wire stripping pliers, 160 mm
- Cable knife, 1-piece
- PUK pocket saw, fixed handle
- Double-face sledge hammer, 1000 g
- VDE/GS Voltage tester - blade 50 mm
- Electricians' chisel, 10 x 250 mm
- Stone chisel, 300 mm
- Engineers' hammer, 300 g
- Spatula, 40 mm
- Plaster container
- Brush



Art. no.	set	empty	kg	PU
220168 *	20-pieces	220060	6,100	1

haupa[®]

... convincing solutions

HAUPA GmbH & Co. KG, Koenigstr. 165-169, 42853 Remscheid, Phone: +49 (0)2191 8418-0, Fax: +49 (0)2191 8418-840, sales@haupa.com

Tool case "Start VDE"

Tool case for apprentices, made from black coloured cowhide equipped with 20 tools, case 220060.

Content:

- 2C-VDE telephone pliers, 200 mm
- 2C-VDE combination pliers, 180 mm
- 2C-VDE cutters, 160 mm
- 2C-VDE wire stripping pliers, 160 mm
- 2C-VDE electrician's screwdrivers, 2,5 x 75, 4 x 100, 5,5 x 125, 6,5 x 150 mm
- 2C-VDE cross slotted screwdrivers PH, size 1 + 2
- Cable knife, 1 blade
- Electricians' chisel, 10 x 250 mm
- VDE/GS Voltage tester - blade 50 mm
- PUK pocket saw, fixed handle
- Brush
- Stone chisel, 300 mm
- Engineers' hammer, 300 g
- Double-face sledge hammer, 1000 g
- Spatula, 40 mm
- Plaster container



Art. no.	set	empty	kg	PU
220168/VDE	20-pieces	220060	6,700	1

Tool case "Delux" 1000 V

of signal-red leather, with 54 safety tools, case 220142

Content:

- 2C-VDE electrician's screwdriver 2,5 x 75, 4 x 100, 5,5 x 125, 6,5 x 150 mm
- 2C-VDE cross slotted screwdriver PH, size 1 + 2
- VDE telephone pliers, straight, 200 mm
- VDE telephone pliers, bent, 200 mm
- VDE combination pliers 185 mm
- VDE side cutters 165 mm
- VDE wire stripping pliers 160 mm
- Socket wrenches 5,5, 7,0, 8,0, 10,0 mm
- Voltage tester „Profi“
- Hexagon sockets 10, 11, 12, 13, 14, 15, 16
- Reversible ratchet 1/2"
- T-sliding handle 1/2"
- Open end spanners 10, 12, 13, 19, 22, 24
- Cable knife
- Cable scissor 200 mm
- Slip-on bushes 5-pieces No. 1, 10 mm
- Slip-on bushes 5-pieces No. 2, 10 mm
- Slip-on bushes 5-pieces No. 3, 10 mm
- Plastic pliers 180 mm
- Plastic clamp
- Covering tape, grey
- Covering tape, red
- Safety grip
- Gloves size 9



Art. no.	set	empty	kg	PU
220135	54-pieces	220142	9,460	1

Tool cases 1000 V

Tool case "Rotor" 1000 V

of signal-red leather, with 46 safety tools, case 220142

Content:

- VDE combination pliers 185 mm
- VDE side cutters 165 mm
- VDE wire stripping pliers
- VDE round nose pliers 160 mm
- Plastic clamp
- Gloves, size 10
- 2C-VDE electrician's screwdrivers 2,5 x 75, 4 x 100 mm
- Safety grip
- Socket wrenches, size 6, 7, 8, 9
- Rubber towels 1000 mm
- 5 slip-on-bushes size 1, 10 mm
- 5 slip-on-bushes size 2, 10 mm
- 5 slip-on-bushes size 3, 10 mm
- 5 slip-on-bushes 10 mm
- 5 slip-on-bushes 20 mm
- 5 slip-on-bushes 30 mm
- Cable knives
- Voltage tester 150 - 250 V



Art. no.	set	empty	kg	PU
220140	46-pieces	220142	6,400	1

haupa[®]

... convincing solutions

HAUPA GmbH & Co. KG, Koenigstr. 165-169, 42853 Remscheid, Phone: +49 (0)2191 8418-0, Fax: +49 (0)2191 8418-840, sales@haupa.com

Hard-top tool cases

Tool case "Start-up S"

ABS

Hard-top case, black, interior features: 2 tool panels with Velcro fasteners, the bottom tray has variable partitions.



Art. no.	width	depth	height	kg	PU
220028	460	310	180	4,500	1

Tool case trolley "Start-up Profi"

ABS

rigid case, made of ABS-plastic material, black, integrated rolls and pull-out handle in the bottom, locks of alu-press-casting, empty. Inside: 1 separation for documents, 1 plate for tools, 1 cover-plate with pocket compartments and clip-compartment, 1 bottom-tray



Art. no.	width	depth	height	kg	PU
220023 *	460	160	310	6,740	1

Tool case "Start-up Profi"

ABS

Hard-top case, black, 2 tool kits, document pocket with hook-and-loop fixing, combination lock, bottom half of case equipped with variable partitions, shoulder strap



Art. no.	width	depth	height	kg	PU
220031 *	500	210	430	6,740	1

Tool case "OmegaMax"

ABS+

rigid case, black, 28 compartments, 1 combination lock, 1 separation for documents, 2 plate for tools, 2 lockable locks, ground bowl with variables to dividing bars, framed push border



Art. no.	width	depth	height	kg	PU
220042	470	200	360	6,500	1

Hard-top tool cases

Tool case trolley "OmegaMax Trolley"

ABS+

rigid case, black, 28 compartments, 1 combination lock, 1 separation for documents, 2 plate for tools, 2 lockable locks, ground bowl with variables to dividing bars, framed push border



Art. no.	width	depth	height	kg	PU
220048 *	470	200	360	7,000	1

Tool case "Omega"

ABS+

rigid case, black, 28 compartments, 1 combination lock, 1 separation for documents, 2 plate for tools, 2 lockable locks, ground bowl with variables to dividing bars, framed push border



Art. no.	width	depth	height	kg	PU
220068	460	180	310	5,039	1

Tool case "Aktion"

ABS+

2 tool kits (one with document pocket). Ground bowl with variables to dividing bars



Art. no.	width	depth	height	kg	PU
220038	460	160	310	4,580	1

Tool case trolley "Fly"

HDPEfly

hard-side case, HDPE, extremely robust, black, 3 tool sections, 2 locks, document pocket, with high-grade fittings, bottom half of case equipped with variable partitions



Art. no.	width	depth	height	kg	PU
220248	470	360	220	5,320	1

haupa®

... convincing solutions

HAUPA GmbH & Co. KG, Koenigstr. 165-169, 42853 Remscheid, Phone: +49 (0)2191 8418-0, Fax: +49 (0)2191 8418-840, sales@haupa.com

Hard-top tool cases

Tool case "Pendant"

ABS+

rigid case, signal red, with Alu frame and 2 locks, with 3 plates with many compartments for tools



Art. no.	width	depth	height	kg	PU
220076	460	180	310	5,107	1

Installation case "Extreme"

PPsafe

Unloaded tool trolley, developed specifically for professionals for transporting a variety of hand tools, power tools and spare parts, making it the perfect companion. In a robust injection-moulded copolymer polypropylene case that can withstand shocks, rough use and extreme weather conditions, with two side handles, one extendible trolley handle (up to 990mm long) and four sturdy and low-noise wheels. The upper compartment, sealed under the top lid, contains a removable tray for spare hand tools which are arranged in a deeper section, where, for example, a laptop could be stored. The lower compartment, protected by a foldable front door, can hold 3 to 8 removable drawers of variable heights (30-60-95mm), with a variety of optional inner configurations, such as, for example, bicolour foam layers, trays for small items and even specially developed tool palettes for all types of small and large hand tools. All drawers can be opened fully and are self-locking to prevent items accidentally falling out. A central key lock and metal reinforced padlock ensure that all compartments are fully secured using a single key.

- 2 carry handles on the sides
- Telescopic handle for trolley function
- 4 robust and low-noise wheels
- Drawer system on the front
- Removable tray in the upper compartment
- Central lock with key
- Space for labels to mark contents
- 2 robust cover fastenings
- 2 robust locks for the front flap
- Fully configurable drawers
- Stackable



Art. no.	width	depth	height	kg	PU
220311	581	455	381	14,107	1

Tool case trolley "Extreme"

PPsafe

Empty, waterproof and perfectly sealed thanks to the embedded neoprene O rings and pressure relief valve, this case provides absolute protection for your tools. Manufactured from durable, light polypropylene, it is equipped with tough locks and an ergonomic handle. These are ideal for use in harsher environments, e.g. in the industrial, aviation, military and marine sectors.

- Waterproof polypropylene case
- Waterproof and airtight according to IP 67
- Airworthy
- Extendible handle for trolley function
- Stackable
- Corrosion-resistant, sand and dust-tight
- Corrosion-resistant metal hinge
- Shock and crushproof
- For use in temperatures between -33°C and +90°C
- Ergonomic and rubberised handle
- Sturdy and user-friendly locks
- Manual pressure relief valve
- Embedded O ring seal in the lid



Art. no.	width	depth	height	kg	PU
220299	517	277	217	7,500	1

Hard-top tool cases

Tool case „ElektroCombo“

black plastic case with metal catch, complete tool set for electricians and network technicians, case: 490 x 375 x 100 mm

Content:

- 2C-VDE combination pliers, 180 mm
- 2C-VDE side cutters, 160 mm
- 2C-VDE wire stripping pliers, 160 mm
- 2C-VDE long chain nose pliers, straight, 200 mm
- Cable cutter 160 mm, coating-insulated
- Crimping pliers for end sleeves 0,25 - 2,5 mm²
- Set ball point allen keys 9-pcs., extra long
- 2C exchangeable „Vario“ handle
- „Vario“ replaceable blade - slotted blade 2.5, 3, 4, 5.5 mm
- „Vario“ replaceable blade - Phillips blade 1, 2
- „Vario“ replaceable blade - pozidrive blade 1, 2
- „Vario“ replaceable blade - pozidrive blade/slotted 1 + 2
- Voltage tester „Basic“, black
- Spanners for switch-cabinets „HUPkey“
- Utility knives
- Junior hacksaw 150 mm
- Electricians' chisels 10 x 250 mm
- Cabinet levels 230 mm
- Measuring tape, 5 m
- Reversible ratchet 1/4"
- Engineers' hammer, 300 g
- Extension 1/4" 100 mm
- Sockets 1/4"
 - WS: 4, 4.5, 5, 5.5, 6, 7, 8, 9, 10, 11, 12, 13, 14 mm
- Ratchet screwdriver „FlexPlus“ for long bits
- 1/4" Bits 50mm HEX 2, 2.5, 3, 4, 5, 6
- 1/4" Bits 50mm PH 0, 1, 2, 3
- 1/4" Bits 50mm PZ 0, 1, 2, 3
- 1/4" Bits 50mm FD 3, 4, 5, 6
- 1/4" Bits 50mm TX 10, 15, 20, 25, 30, 40
- 1/4" Bits 50mm PZ/FL 1 + 2
- 1/4" SQ x 1/4" HEX adapter 50 mm
- Assortment box 160 x 115 x 40 mm



Art. no.	set	width	depth	height	kg	PU
104090	78-pieces	490	100	375	6,000	1

Tool case „Start-up Light“

ABS

hard-shell case, black, 2 tool sections, bottom with variable partitions, 14 tools, case art. 220028 „Start-up S“

Content:

- 2C Electricians' screwdrivers 2,5 x 75 mm, 4 x 100 mm, 5,5 x 125 mm
- 2C Cross slotted screwdrivers PH, size 1 + 2
- 2C Combination pliers, 180 mm
- 2C Side cutters, 160 mm
- 2C long chain nose pliers, 200 mm
- Stripper „All-rounder“ 4 - 15 mm
- Junior hacksaw DIN 6473 C, 150 mm with blade
- Engineers' hammer, 300 g
- Cable stripping knives, shock-proof synthetic
- Carpenters' pencils
- Measuring tape, 3 m



Art. no.	set	empty	kg	PU
220269	14-pieces	220028	5,900	1

haupa[®]

... convincing solutions

HAUPA GmbH & Co. KG, Koenigstr. 165-169, 42853 Remscheid, Phone: +49 (0)2191 8418-0, Fax: +49 (0)2191 8418-840, sales@haupa.com

Hard-top tool cases

Tool case „Start-up Go“

ABS

hard-shell case, black, 2 tool sections, bottom with variable partitions, 18 tools, case art. 220028 „Start-up S“

Content:

- 2C-VDE electricians' screwdrivers 2,5 x 75 mm, 4 x 100 mm, 5,5 x 125 mm, 6,5 x 150 mm
- 2C-VDE cross slotted screwdrivers PH, size 1 + 2
- 2C-VDE combination pliers, 180 mm
- 2C-VDE side cutters, 160 mm
- 2C-VDE long chain nose pliers, 45° angled nose, 200 mm
- Cable knife VDE with a straight blade
- Automatic wire stripper Super Plus 0,2 - 6 mm²
- Cable stripping knife 8 - 28 mm²
- Set ball point allen keys 9-pcs., 1,5 - 10 mm, extra long
- Spanners for switch-cabinets „HUPkey“
- PUK pocket saw, fixed handle
- Engineers' hammer, 300 g
- Carpenters' pencils
- Measuring tape, 3 m



Art. no.	set	empty	kg	PU
220267	18-pieces	220028	6,100	1

Tool case „Jobstarter Plus“

ABS

RRobust hard case, black. Interior equipment: 2 tool boards, bottom plate with variable dividers. Case 220028.

Content:

- 2C-VDE telephone pliers, 200 mm
- 2C-VDE combination pliers, 180 mm
- 2C-VDE side cutters, 160 mm
- 2C-VDE telephone pliers, 200 mm
- Stripping pliers 0,5 - 4,0 mm²
- Cable cutter VDE, straight
- Wire stripper, hooked blade, 8 - 28 mm Ø
- PUK pocket saw
- 2C-VDE electrician's screwdrivers, 2,5 x 75, 3,5 x 100, 5,5 x 125, 6,5 x 150 mm
- 2C-VDE cross slotted screwdrivers PH 1 + 2
- 2C-VDE cross slotted screwdrivers PZ 1 + 2
- VDE/GS-Voltage testers, 120 - 250 V, loose
- Electricians' chisel, 10 x 250 mm
- Stone chisels, flat oval shank
- Engineers' hammer
- Sledge hammer
- Industrial ring brush, size 4
- Paint scraper
- Plaster cup
- Carpenters' pencil, 150 mm



Art. no.	set	empty	kg	PU
220027	24-pieces	220028	8,080	1

Hard-top tool cases

Tool case „Start-up Max“

ABS 

hard-shell case, black, 2 tool sections, bottom half of case equipped with variable partitions, 24 tools, case art. 220028 „Start-up S“

Content:

- 2C-VDE electricians' screwdrivers
2,5 x 75 mm, 4 x 100 mm, 5,5 x 125 mm, 6,5 x 150 mm
- 2C-VDE cross slotted screwdrivers PH, size 1 + 2
- 2C-VDE combination pliers, 180 mm
- 2C-VDE long chain nose pliers, 45° angled nose, 200 mm
- 2C-VDE side cutters, 160 mm
- 2C-VDE cable cutters, 160 mm
- Cable knife VDE with a straight blade
- Automatic wire stripper Super Plus 0,2 - 6 mm²
- Cable stripping knife 8 - 28 mm²
- Voltage tester „Profi LEDplus II“ 3 - 1.000 V
- Crimping pliers for end sleeves 0,25 - 2,5 mm²
- Dispenser box with insulated end sleeves, colour range III, DIN
- Combination spanners similar to DIN 3113, 8-pcs.
- Set ball point allen keys 9-pcs., 1,5 - 10 mm, extra long
- Spanners for switch-cabinets „HUPkey“
- LED „Pen Torch“
- PUK pocket saw, fixed handle
- Engineers' hammer, 300 g
- Carpenters' pencils
- Measuring tape, 3 m



Art. no.	set	empty	kg	PU
220268 *	24-pieces	220028	8,500	1

Tool case “Start-up”

ABS 

Hard-top case, black, 2 tool kits, document pocket with hook-and-loop fixing, combination lock, bottom half of case equipped with variable partitions, shoulder strap, 19 tools.

Content:

- 2C-VDE electrician's screwdrivers
2.5 x 75, 4 x 100, 5.5 x 125 und 6.5 x 150 mm
- 2C-VDE cross slotted screwdrivers, PH, size 1 + 2
- 2C combination pliers, 185 mm
- 2C side cutters, 165 mm
- 2C telephone pliers, 200 mm
- 2C wire stripping pliers, 160 mm
- Wire stripper, hooked blade, 8 - 28 mm Ø
- Cable knife, 1-pieces
- Engineers' hammer, 300 g
- PUK pocket saw, fixed handle
- Electricians' chisel, 10 x 250 mm
- Paint scraper, 40 mm
- Voltage tester, blade 50 mm
- Measuring tape, 3 m
- Water brush



Art. no.	set	empty	kg	PU
220221	19-pieces	220031	9,180	1

haupa[®]

... convincing solutions

HAUPA GmbH & Co. KG, Koenigstr. 165-169, 42853 Remscheid, Phone: +49 (0)2191 8418-0, Fax: +49 (0)2191 8418-840, sales@haupa.com

Hard-top tool cases

Tool case "Start-up VDE"

ABS

Hard-top case, black, 2 tool kits, document pocket with hook-and-loop fixing, combination lock, bottom half of case equipped with variable partitions, shoulder strap, 19 tools.

Content:

- 2C-VDE electrician's screwdrivers
2,5 x 75, 4 x 100, 5,5 x 125 und 6,5 x 150 mm
- 2C-VDE cross slotted screwdrivers, PH, size 1 + 2
- 2C-VDE combination pliers 185 mm
- 2C-VDE side cutters 165 mm
- 2C-VDE telephone pliers 200 mm
- 2C-VDE wire stripping pliers 160 mm
- Wire stripper, hooked blade, 8 - 28 mm Ø
- Cable knife, 1-pieces
- Engineers' hammer, 300 g
- PUK pocket saw, fixed handle
- Electricians' chisel, 10 x 250 mm
- Paint scraper, 40 mm
- Voltage tester, blade 50 mm
- Measuring tape,
- Water brushes



Art. no.	set	empty	kg	PU
220235 *	19-pieces	220031	9,300	1

Tool case "EXTRA"

ABS

Hard-side case, black, 2 tool sections, document pocket, combination lock, bottom half of case equipped with variable partitions, with high-grade fittings, 2 locks, 19 tools, case 220031.

Content:

- 2C-VDE screwdriver set PZ, 101999/PZ
- 2C-VDE cross slotted screwdrivers PH, size 1
- 2C-VDE cross slotted screwdrivers PH, size 2
- Automatic wire stripper Super Plus 0,2-6 mm²
- Cable stripping knives without hook blade 8-28 mm²
- Voltagetester „Basic“ black
- Combination pliers VDE 185 mm
- Heavy duty diagonal cutters VDE 205 mm
- Long chain nose pliers VDE angled 200 mm
- Carpenters' pencils
- Engineers' hammers 300 g
- Electricians' chisels 10x250 mm
- Hand saws „PUK“ mit fixed handle
- Torped-level 225 mm
- Folding rules 2 m
- Paint scrapers 40 mm
- Water brushes
- Plaster cups
- Cable knives 1000 V, 50 mm
- Sledge hammers 1000 g
- Stone chisels, flat oval shank 28x250 mm
- Industrial cleaning wipes
- Crimping pliers crimping pliers for insulated terminals and end sleeves 0,5 - 6 mm
- Stripper 8-13 mm²
- Cable cutters VDE 170 mm
- Electrical insulating tape VDE 15 mm x 10 m, Rainbow pack, 263820, 10 colours
- Voltage tester „Profi plus“
- HAUPA „Multi Check“ digital high-capacity multimeter



Art. no.	set	empty	kg	PU
220309	33-pieces	220031	8,680	1

Tool cases 1000 V

Tool case "Profi VDE" 1000 V

ABS

Hard-top case, black, 2 tool kits, document pocket with hook-and-loop fixing, combination lock, bottom half of case equipped with variable partitions, shoulder strap, 35 tools, case 220031.

Content:

- VDE long chain nose pliers, straight, 200 mm
- VDE combination pliers 185 mm
- VDE heavy duty side cutters 200 mm
- VDE wire stripping pliers 160 mm
- VDE cable cutter, max. 15 mm
- Cable knives, 1000 V, 50 mm
- Finger gloves, size 9
- 2C-VDE electrician's screwdrivers 2,5 x 75, 3 x 100, 6,5 x 150, 8 x 175 mm
- 2C-VDE socket wrenches, size 5,5, 7, 8, 10
- 2C-VDE cross slotted screwdrivers, PH 1 + 2
- NH-safety fuse grip
- Rubber towels, 1000 x 1000 x 1,6 mm
- Plastic clips, 160 mm
- Slip on bushes, No. 1, 2, 3 (each 5 x)
- Self adhesive PVC tape, red, 10 m
- Heat protection gloves
- Safety glasses



1000 V IEC 60900



Art. no.	set	empty	kg	PU
220232	35-pieces	220031	12,920	1

Hard-top tool cases

Tool case trolley "Profi mobil"

ABS

Hard-side case, black, 2 tool sections, document pocket, combination lock, bottom half of case equipped with variable partitions, with high-grade fittings, 2 locks, 51 tools, case art. 220023.

Content:

- 2-component socket wrenches set
- 2-component screwdrivers 2,5 x 75, 3 x 100, 4 x 100, 4 x 125, 5 x 150 mm
- Cross slotted screwdrivers PH, size 1+2, insulated
- Voltage tester "Basic" 6-400 V
- Electronic screwing bit set, 34-pcs
- HAUPA ratchet screwdriver „Flex“, 58-pcs
- Combination spanners sets, 12-pcs
- Adjustable single-head wrench 24 mm
- Spanners for switch-cabinets
- Engineers' hammer, 300 g
- Cable stripping knives with hook blade, 8-28 mm²
- Utility knives „EXTRA“ with spare blades 19 mm
- Cable cutter with a snap, max. 16,9 mm
- Cable cutter 160 mm, dipped
- 2C combination pliers 185 mm
- 2C diagonal cutter 165 mm
- 2C long chain nose pliers 200 mm
- Automatic wire stripper Super Plus 0,2-6 mm²
- ESD Electronic side cutter 115 mm
- Measuring tape 5 m
- Cabinet levels 250
- VDE electrical insulating tape 19 mm x 20 m, black (8x)



Art. no.	set	empty	kg	PU
220273	51-pieces	220023	14,700	1

haupa[®]

... convincing solutions

Hard-top tool cases

Tool case trolley "Start-up"

ABS

Hard-side case, black, 2 tool sections, document pocket, combination lock, bottom half of case equipped with variable partitions, with high-grade fittings, 2 locks, 19 tools, case art. 220023.

Content:

- 2C-VDE electricians' screwdrivers 2,5 x 75, 4 x 100, 5,5 x 125, 6,5 x 150 mm
- 2C-VDE cross slotted screwdrivers PH, size 1 + 2
- 2C-VDE combination pliers, 185 mm
- 2C-VDE side cutters, 165 mm
- 2C-VDE telephone pliers, 200 mm
- 2C-VDE wire stripping pliers, 160 mm
- Wire stripper, hooked blade, 8 - 28 mm Ø
- Cable knife, 1 blade
- Engineers' hammer, 300 g
- PUK pocket saw, fixed handle
- Electricians' chisel, 10 x 250 mm
- Paint scraper, 40 mm
- Voltage tester, blade 50 mm
- Measuring tape, 3 m
- Water brushes



Art. no.	set	empty	kg	PU
220252	19-pieces	220023	10,940	1

Tool case trolley "Master"

ABS

Hard-side case, black, 2 tool sections, document pocket, combination lock, bottom half of case equipped with variable partitions, with high-grade fittings, 2 locks, 38 tools, case art. 220023.

Content:

- 2C-VDE-screwdrivers set PH
- VDE-Cable knife straight blade
- Industrial cleaning wipes
- Measuring tape 3 m
- PUK pocket saw, fixed handle
- VDE cable cutter 230 mm
- 2C-VDE combination pliers 185 mm
- VDE side cutters 165 mm
- VDE telephone pliers 45°, 200 mm
- Automatic wire stripper 0,2 - 6 mm²
- Ear protection plugs SNR 30 db
- 2C-VDE screwdrivers PZ/FL, size 1
- 2C-VDE screwdrivers PZ/FL, size 2
- Perlon fish tapes 15 mm, 3
- LED Pocket lamp 18 x 91mm 80 lm
- Universal stripper 0,2 - 4 mm²
- Wire stripper, hooked blade, 8 - 28 mm Ø
- Crimping pliers for crimp terminals/end sleeves
- Cable cutter 160 mm, coating-insulated
- Crimping pliers 0,75 - 16 mm²
- Ratched screwdriver „Flex“, 58 pcs.
- Safety glasses
- Spanner for switch-cabinets
- Voltage tester „Profi Plus“
- Elektronik ESD Electronic side cutter 115 mm
- Adjustable single-head wrench 24 mm
- 2C Allround soft-grip scissors 140 mm
- Cable glands IP 68, M20, light-grey
- Dispenser box with insulated end sleeves (DIN)
- Cable ties UV-resistant 250 x 4,8 mm
- Nailing clips for round cable 7-10, white



Art. no.	set	empty	kg	PU
220254 *	38-pieces	220023	14,700	1

Hard-top tool cases

Werkzeug-Trolley „Master Mobil“ 1000 V“

ABS

hard-side case, black, 2 tool sections, document pocket, combination lock, bottom half of case equipped with variable partitions, with high-grade fittings, 2 locks, 38 tools, case 220023.

Content:

- 2C-VDE-screwdrivers set HUPslim PH
- 2C-VDE screwdrivers HUPslim PZ/FL, size 1 + 2
- VDE-Cable knife straight blade
- 2C-VDE combination pliers 180 mm
- VDE side cutters 160 mm
- VDE telephone pliers 45°, 200 mm
- Industrial cleaning wipes • Measuring tape 3 m
- PUK pocket saw, fixed handle • VDE cable cutter 230 mm
- Automatic wire stripper 0,2 - 6 mm²
- Ear protection plugs SNR 30 db • Perlon fish tapes 15 mm, 3
- LED Pocket lamp 18 x 91mm 80 lm
- Universal stripper 0,2 - 4 mm²
- Wire stripper, hooked blade, 8 - 28 mm Ø
- Crimping pliers for crimp terminals/end sleeves
- Cable cutter 160 mm, coating-insulated
- Crimping pliers 0,75 - 16 mm²
- Ratched screwdriver "Flex", 58 pcs.
- Safety glasses • Spanner for switch-cabinets
- Voltage tester "Profi Plus"
- 2C Allround soft-grip scissors 140 mm
- Elektronik ESD Electronic side cutter 115 mm
- Adjustable single-head wrench 24 mm
- Cable glands IP 68, M20, light-grey
- Dispenser box with insulated end sleeves (DIN)
- Cable ties UV-resistant 250 x 4,8 mm
- Nailing clips for round cable 7-10, white



Art. no.	set	empty	kg	PU
220329	38-pieces	220023	14,700	1

Tool case trolley "EXTRA"

ABS

Hard-side case, black, 2 tool sections, document pocket, combination lock, bottom half of case equipped with variable partitions, with high-grade fittings, 2 locks, 19 tools, case 220023.

Content:

- 2C-VDE screwdriver set PZ, 101999/PZ
- 2C-VDE cross slotted screwdrivers PH, size 1
- 2C-VDE cross slotted screwdrivers PH, size 2
- Automatic wire stripper Super Plus 0,2 - 6 mm²
- Cable stripping knives without hook blade 8 - 28 mm²
- Voltagetester „Basic“ black
- Combination pliers VDE 185 mm
- Heavy duty diagonal cutters VDE 205 mm
- Long chain nose pliers VDE angled 200 mm
- Carpenters' pencils
- Engineers' hammers 300 g
- Electricians' chisels 10 x 250 mm
- Hand saws „PUK“ mit fixed handle
- Torped-level 225 mm
- Folding rules 2 m
- Paint scrapers 40 mm
- Water brushes
- Plaster cups
- Cable knives 1000 V, 50 mm
- Sledge hammers 1000 g
- Stone chisels, flat oval shank 28 x 250 mm
- Industrial cleaning wipes
- Crimping pliers crimping pliers for insulated terminals and end sleeves 0,5 - 6 mm
- Stripper 8 - 13 mm²
- Cable cutters VDE 170 mm
- Electrical insulating tape VDE 15 mm x 10 m, Rainbow pack, 263820, 10 couloors
- Voltage tester „Profi plus“
- HAUPA „Multi Check“ digital high-capacity multimeter



Art. no.	set	empty	kg	PU
220307	33-pieces	220023	15,000	1

haupa

... convincing solutions

HAUPA GmbH & Co. KG, Koenigstr. 165-169, 42853 Remscheid, Phone: +49 (0)2191 8418-0, Fax: +49 (0)2191 8418-840, sales@haupa.com

Service trolley for hybrid vehicles 1000 V

ABS

Hard-side case, black, 2 tool sections, document pocket, combination lock, bottom half of case equipped with variable partitions, with high-grade fittings, 2 locks, case art. 220023.

Content:

- 2C-VDE electrician's screwdrivers 2,5 x 75, 3 x 100, 3,5 x 100, 4 x 100 mm
- 2C-VDE cross slotted screwdrivers PH 1, 2, 3
- 2C-VDE cross slotted screwdrivers S-Tx 20, 25, 30
- Hexagon sockets VDE 3/8" WS 8, 9, 10, 12, 13, 14, 17, 19, 22
- Extension 3/8" VDE, 250 mm
- Reversible ratchet VDE 3/8"
- Water pump pliers VDE 240 mm
- Cable cutters VDE 230 mm
- Side heavy duty side cutters VDE 205 mm
- Side cutters VDE 165 mm
- Short flat nose pliers VDE 160 mm
- Long chain nose pliers, angled nose 200 mm
- Combination pliers VDE 205 mm
- Cable stripping knife 1000V, straight blade, 50 mm
- Safety-sets with bag, insulating mat
- Slip on bushes 1000V, 20 mm
- Slip on bushes 1000V, 10 mm
- **VDE-sockets 3/8", M8, M10, M12 (xzn)**
- Shutting band red/white 500 m
- Sign „dangerous voltage“
- Sign „do not switch“

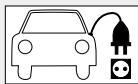

Art. no.	set	empty	kg	PU
220171	40-pieces	220023	11,100	1

Tool case trolley "Secure mobil" 1000 V

ABS

Hard-side case, black, 2 tool sections, document pocket, combination lock, bottom half of case equipped with variable partitions, with high-grade fittings, 2 locks, 57 tools, case art. 220023.

Content:

- 2C-VDE electricians' screwdrivers 2,5 x 75, 4 x 100, 5,5 x 125, 6,5 x 150 mm
- 2C-VDE cross slotted screwdrivers PH, size 1 + 2
- Voltage tester "Profi plus" 12-1,000 V
- Single ended spanner 1000 V 10, 12, 13, 19, 22, 24
- Finger gloves 1000 V, size 9
- Safety fuse grips
- Flat nose pliers 1000 V
- Slip on bushes 1000 V no. 1,2, 3 (each 5x)
- VDE cable knife, 50 mm
- VDE combination pliers 185 mm
- VDE diagonal cutter 165 mm
- VDE long chain nose pliers 200 mm
- Tool case 1000 V, drive 3/8"
- Electrical insulating tape, red (6x)



Art. no.	set	empty	kg	PU
220272	57-pieces	220023	14,700	1

Hard-top tool cases

Tool case "2 component"

ABS+ 

Hard-top case, for apprentices, black, 2 tool kits, one with document pocket, cover-plate with pocket compartments and clip-compartment, 18 tools. Case 220038.

Content:

- 2C telephone pliers, straight, 200 mm
- 2C combination pliers, 180 mm
- 2C heavy duty side cutters, 180 mm
- 2C wire stripping pliers, 160 mm
- 2C electrician's screwdrivers 2.5 x 75, 3 x 100, 5.5 x 125, 6.5 x 150 mm
- 2C cross slotted screwdrivers, PH, size 1 and 2
- Cable knife, 1-pieces
- Wire stripper, hooked blade, 8 - 28 mm Ø
- PUK pocket saw, fixed handle
- Paint scraper, 40 mm
- Electricians' chisel, 10 x 250 mm
- Voltage tester, 220 - 250 volt
- Engineers' hammer, 300 g
- Measuring stick, 2 m



Art. no.	set	empty	kg	PU
220170	18-pieces	220038	7,000	1

Network service case

ABS+ 

Hard-top case, black, for electricians and network technicians, 2 tool kits (one with document pocket), bottom half of case contains 8 small removable boxes, secured for transport purposes. Case 220038.

Content:

- 2C side cutters, 160 mm
- 2C telephone pliers, 180 mm
- 2C telephone pliers, 200 mm, bent
- 2C electrician screwdrivers 75, 100, 150 mm
- 2C cross slotted screwdrivers PH, size 0, 1, 2
- Electronic screwdriver set, 7-pieces
- Control cabinet key
- Precision stripper "PWS-Plus" 0.25 - 0.8 Ø
- Combination snips 190 mm
- „PUK“ pocket saw, fixed handle
- Crimping pliers for coaxial connectors
- ESD electronic side cutters, 130 mm
- Stripper for coaxial cable
- VDE/GS voltage tester
- Stripper for UTP/STP data cable
- Crimping pliers for modular plugs
- Sensor tool



Art. no.	set	empty	kg	PU
220141	21-pieces	220038	8,800	1

haupa[®]

... convincing solutions

HAUPA GmbH & Co. KG, Koenigstr. 165-169, 42853 Remscheid, Phone: +49 (0)2191 8418-0, Fax: +49 (0)2191 8418-840, sales@haupa.com

Hard-top tool cases

Tool case "Panther"

ABS+

inside: 1 separation for documents, 2 plate for tools, 1 cover-plate with pocket compartments and clip-compartment. Case 220038.

Content:

- 2C electrician's screwdrivers, 75, 100, 125, 150 mm
- 2C engineers' screwdriver, 100 mm
- 2C cross slotted screwdrivers, PZ, size 1 and 2
- Control cabinet key
- Jointing chisel, 26 x 250 mm
- Electrician's chisel, 10 x 250 mm
- Cable stripping knife, plastic shank
- Universal saw, heavy 150 mm
- 2C combination pliers, 180 mm
- 2C heavy duty side cutters, 180 mm
- 2C telephone pliers, 200 mm
- 2C wire stripping pliers, 160 mm
- Cabinet level, 250 mm
- Wire stripper, hooked blade, 8 - 28 mm Ø
- Bench hammer, 300 g
- Voltage tester "Basic"
- VDE/GS voltage tester



Art. no.	set	empty	kg	PU
220040	21-pieces	220038	7,460	1

Tool case "Compact"

ABS+

Hard-top case, black, 2 tool kits (one with document pocket), bottom half of case equipped with variable partitions, case 220038.

Content:

- 2C electrician's screwdrivers, 2,5 x 75, 4 x 100, 4 x 125, 5 x 150 mm
- 2C cross slotted screwdrivers, PH, size 1 and 2
- Electronic screwdriver set, 7-pieces
- 2C combination pliers, 180 mm
- 2C side cutters, 160 mm
- 2C telephone pliers, 200 mm
- Wire stripper, hooked blade, 8 - 28 mm Ø
- Cable stripping knife, 4 - 16 mm Ø
- Automatic wire stripper, 0,2 - 6 mm²
- Cable cutter with a snap
- 2K Soft-Grip scissor, 140 mm
- PUK pocket saw, fixed handle
- HAUPA „Bit box“, 17-pieces
- SDS-plus set, 5-pieces
- Spirit level, 400 mm
- Measuring tape, 3 m
- Voltage tester „Basic“



Art. no.	set	empty	kg	PU
220229	47-pieces	220038	7,180	1

Hard-top tool cases

Tool case "Basic"

ABS+

Hard-top case, black, 2 tool kits (one with document pocket), bottom half of case equipped with variable partitions, 19 tools. Case 220038.

Content:

- 2C-VDE electrician's screwdrivers, 2.5 x 75, 4 x 100, 5.5 x 125, 6.5 x 150 mm
- 2-VDE cross slotted screwdrivers PH, size 1 and 2
- 2C combination pliers, 180 mm
- 2C side cutters, 160 mm
- 2C telephone pliers, straight, 200 mm
- 2C wire stripping pliers, 160 mm
- Wire stripper, hooked blade, 8 - 28 mm Ø
- Cable knife, 1-pieces
- Engineers' hammer, 300 g
- PUK pocket saw, fixed handle
- Electricians' chisel, 10 x 250 mm
- Voltage tester blade, 50 mm
- Measuring stick, 2 m
- Paint scraper, 40 mm
- Water brushes



Art. no.	set	empty	kg	PU
220153 *	19-pieces	220038	6,600	1

Tool case "Basic VDE"

ABS+

Hard-side case, black, 2 tool sections (one with document pocket), bottom half of case equipped with variable partitions, with high-grade fittings, 19 tools. Case 220038.

Content:

- 2C-VDE electrician's screwdrivers, 2.5 x 75, 4 x 100, 5.5 x 125, 6.5 x 150 mm
- 2-VDE cross slotted screwdrivers PH, size 1 + 2
- 2C-VDE combinations pliers, 185 mm
- 2C-VDE side cutters 165, mm
- 2C-VDE telephone pliers, straight, 200 mm
- 2C-VDE cable cutter 200 mm
- Wire stripper, hooked blade, 8 - 28 mm Ø
- Cable knife, 1 blade
- Engineers' hammer, 300 g
- PUK pocket saw, fixed handle
- Electricians' chisel, 10 x 250 mm
- Voltage tester blade, 50 mm
- Measuring stick, 2 m
- Paint scraper, 40 mm
- Water brushes



Art. no.	set	empty	kg	PU
220244	19-pieces	220038	7,140	1

haupa®

... convincing solutions

HAUPA GmbH & Co. KG, Koenigstr. 165-169, 42853 Remscheid, Phone: +49 (0)2191 8418-0, Fax: +49 (0)2191 8418-840, sales@haupa.com

Hard-top tool cases

Tool case "Inspektor"

ABS+ 

rigid case, black, with high-grade fittings, Master's case with 25 tools.
Case 220068.

Content:

- 2C electrician's screwdrivers 75, 125, 150 mm
- 2C engineers' screwdrivers 100, 150 mm
- 2C cross slotted screwdrivers PH, size 1 + 2
- 2C combination pliers, 180 mm
- 2C heavy duty side cutters, 180 mm
- 2C telephone pliers, 200 mm
- 2C telephone pliers, bent 200 mm
- 2C water pump pliers, 240 mm
- 2C wire stripping pliers, 160 mm
- 2C piercing awl
- Wire stripper, hooked blade, 8 - 28 mm Ø
- Voltage tester, 150 - 250 V
- Adjustable wrench, 210 mm
- Paint scraper, 50 mm
- Electricians' Chisel, 10 x 250 mm
- Engineers' hammer, 300 g
- Cable knife, 1 blade
- Universal scissors, 190 mm
- PUK pocket saw, fixed handle
- Measuring stick, 2 m
- Alu level 400 mm



Art. no.	set	empty	kg	PU
220176	25-pieces	220068	8,980	1

Tool case "Akkurat"

ABS+ 

Master's case for radio and television, with 32 tools, rigid case. Case 220068.

Content:

- 2C cross slotted screwdrivers, PH, size 1 and 2
- 2C electrician's screwdrivers 2.5 x 75, 4 x 100, 4 x 125, 5 x 150
- 2C electrician's screwdrivers 2.5 x 75 (bare)
- 2C combination pliers, 160 mm
- 2C side cutters, 160 mm
- 2C telephone pliers, straight, 200 mm
- 2C telephone pliers, bent, 200 mm
- 2C wire stripping pliers, 160 mm
- ESD electronic side cutters, 115 mm
- ESD electronic needle nose pliers, 130 mm
- ESD Electronic round nose pliers, 130 mm
- ESD electronic needle nose pliers, 130 mm, 45°
- Engineers' screwdrivers, 8 x 150 mm
- Elektronic screwdriver set, 7-pieces
- Tweezer, straight, 130 mm
- Tweezer, flat, 145 mm
- 2C socket wrenches 5, 5.5, 6
- 2C piercing awl, round
- Voltage tester 50 - 250 Volt
- Checking mirror 210 mm
- Claw holder, size 525
- Spanner, 175 mm
- Solder, Sn 60% 1 mm 100 g
- Universal scissors, 190 mm
- Crown scissors, 115 mm
- Contact file set. 6 pieces



Art. no.	set	empty	kg	PU
220179	32-pieces	220068	8,180	1

Hard-top tool cases

Tool case "Diamant"



Master's case for domestic appliances, with 23 tools, rigid case, black. Case 220068.

Content:

- 2C electrician's screwdrivers 4 x 100, 5 x 150 mm
- 2C engineers' screwdrivers 6 x 100, 8 x 150 mm
- 2C cross slotted screwdrivers, PH, size 1 and 2
- 2C long nose round pliers, 160 mm
- 2C long nose flat pliers, 160 mm
- 2C telephone pliers 200 mm
- 2C telephone pliers, bent, 200 mm
- 2C combination pliers 160 mm
- 2C side cutters, 160 mm
- 2C heavy duty side cutters, 200 mm
- Cable stripper 0.5 - 4 Ø
- ESD electronic side cutters, 115 mm
- Crimping pliers for crimping terminals
- Socket wrench set, 1/4", 33 pieces
- „PUK“ pocket saw, fixed handle
- Bench hammer, 300 g
- Cable stripping knife, plastic scales
- VDE/GS Voltage tester
- Combination snips, 190 mm
- Cable cutter, max. 16.9 Ø



Art. no.	set	empty	kg	PU
220192	23-pieces	220068	8,500	1

The ideal tool assortment



rigid case for electromaster, with 32 tools. Case 220068.

Content:

- 2C electrician screwdrivers 75, 75, 125, 150 mm
- 2C engineers' screwdrivers 100, 150 mm
- 2C cross slotted screwdrivers PH, size 1 + 2
- 2C combination pliers, 180 mm
- 2C telephone pliers, 200 mm
- 2C side cutters, 160 mm
- 2C telephone pliers, 200 mm
- 2C water pump pliers, 240 mm
- ESD electronic side cutters, 115 mm
- ESD electronic needle nose pliers, 130 mm
- Electronic screwdriver set, 7-pieces
- Solder for electronic work, Sn 60%, 1.5 mm, 100 g
- Claw retriever with fixed shaft, size 165
- 2C piercing awl, square
- 2C socket wrenches 7, 8, 10
- Checking mirror, 210 mm
- Socket wrench set, 1/4", 33 piece
- Contact soldering iron, 30 watt
- Cable stripping knife, plastic handle
- Bench hammer, 300 g
- Universal saw, heavy 150 mm
- Cable stripper, 0.5 - 4 mm Ø
- Combination snips, 190 mm
- VDE/GS Voltage tester
- Tweezer angled



Art. no.	set	empty	kg	PU
220177 *	32-pieces	220068	10,260	1

haupa®

... convincing solutions

HAUPA GmbH & Co. KG, Koenigstr. 165-169, 42853 Remscheid, Phone: +49 (0)2191 8418-0, Fax: +49 (0)2191 8418-840, sales@haupa.com

Hard-top tool cases

Tool case "OmegaMax Start VDE"

ABS+ 

rigid case, black, 28 compartments, 1 combination lock, 1 separation for documents, 2 plate for tools, 2 lockable locks, ground bowl with variables to dividing bars, framed push border. Case 220042.

Content:

- 2C-VDE electrician's screwdrivers
2.5 x 75, 4 x 100, 5.5 x 125 und 6.5 x 150 mm
- 2C-VDE cross slotted screwdrivers PH, size 1 + 2
- 2C combination pliers, 185 mm
- 2C side cutters, 165 mm
- 2C telephone pliers, 200 mm
- 2C wire stripping pliers, 160 mm
- Wire stripper, hooked blade, 8 - 28 mm Ø
- Cable knife, 1 blade
- Engineers' hammer, 300 g
- PUK pocket saw, fixed handle
- Electricians' chisel, 10 x 250 mm
- Paint scraper, 40 mm
- Voltage tester, blade 50 mm
- Measuring tape, 3 m
- Water brush



Art. no.	set	empty	kg	PU
220043	19-pieces	220042	11,000	1

Tool case trolley "OmegaMax Trolley Start VDE"

ABS+ 

rigid case, black, 28 compartments, 1 combination lock, 1 separation for documents, 2 plate for tools, 2 lockable locks, ground bowl with variables to dividing bars, framed push border. Tool case 220048.

Content:

- 2C-VDE electrician's screwdrivers
2.5 x 75, 4 x 100, 5.5 x 125 und 6.5 x 150 mm
- 2C-VDE cross slotted screwdrivers PH, size 1 + 2
- 2C combination pliers, 185 mm
- 2C side cutters, 165 mm
- 2C telephone pliers, 200 mm
- 2C wire stripping pliers, 160 mm
- Wire stripper, hooked blade, 8 - 28 mm Ø
- Cable knife, 1 blade
- Engineers' hammer, 300 g
- PUK pocket saw, fixed handle
- Electricians' chisel, 10 x 250 mm
- Paint scraper, 40 mm
- Voltage tester, blade 50 mm
- Measuring tape, 3 m
- Water brush



Art. no.	set	empty	kg	PU
220137	19-pieces	220048	11,500	1

Tool cases 1000 V

Tool case „Delux Plus“ 1000 V

ABS+

rigid case, signal-red, with high-grade fittings, complete with 54 safety tools, case 220076.

Content:

- 2C-VDE electrician's screwdriver 2.5 x 75, 4 x 100, 5.5 x 125, 6.5 x 150 mm
- 2C-VDE cross slotted screwdriver PH, size 1 + 2
- VDE telephone pliers, straight, 200 mm
- VDE telephone pliers, bent, 200 mm
- VDE combination pliers 185 mm
- VDE side cutters 165 mm
- VDE wire stripping pliers 160 mm
- Socket wrenches 5.5, 7, 8, 10 mm
- Voltage tester „Profi“
- Hexagon sockets 10, 11, 12, 13, 14, 15, 16
- Reversible ratchet 1/2"
- T-sliding handle 1/2"
- Open end spanners 10, 12, 13, 19, 22, 24
- Cable knife
- Cable scissors 200 mm
- Slip-on bushes 5-pieces No. 1, 10 mm
- Slip-on bushes 5-pieces No. 2, 10 mm
- Slip-on bushes 5-pieces No. 3, 10 mm
- Plastic pliers 180 mm
- Plastic clamp
- Covering tape, grey
- Covering tape, red
- Safety grip
- Gloves size 9



Art. no.	set	empty	kg	PU
220239 *	54-pieces	220076	11,780	1

Tool case „Leopard“ 1000 V

ABS+

rigid case, signal-red, complete with 32 safety tools (460 x 180 x 310 mm).

Content:

- 2C-VDE electrician's screwdrivers 2,5 x 75, 4 x 100, 6,5 x 150, 8,0 x 175, 10,0 x 200 mm
- 2C-VDE cross slotted screwdrivers PH, size 1 + 2
- 2C-VDE cross slotted screwdrivers PZ, size 1 + 2
- Retaining screwdrivers 100, 125 mm
- Retaining screwdriver, cross-slotted
- Right angle allen keys, 6, 8 mm
- VDE round nose pliers, 160 mm
- VDE telephone pliers, straight, 200 mm
- VDE telephone pliers, bent, 200 mm
- VDE combination pliers 185 mm
- VDE wire stripping pliers 160 mm
- VDE side cutter, 165 mm
- Socket wrenches 5,5, 6, 7, 8 mm
- Voltage Tester „Profi“
- Cable knife, insulated
- Cable knife
- Cable scissor
- Plastic pliers 180 mm
- Covering tape, red 10 m
- NH-safe



Art. no.	set	empty	kg	PU
220136	32-pieces	220076	10,380	1

haupa[®]

... convincing solutions

HAUPA GmbH & Co. KG, Koenigstr. 165-169, 42853 Remscheid, Phone: +49 (0)2191 8418-0, Fax: +49 (0)2191 8418-840, sales@haupa.com

Tool cases 1000 V

Tool case "Power Pack" 1000 V

ABS+

rigid case, signal red, with alu frame and 2 locks, 3 plates with many compartments for tools, case 220076 (460 x 180 x 310 mm).

Content:

- 2C-VDE electrician's screwdrivers 2,5 x 75, 4 x 100, 5,5 x 125 und 6,5 x 150 mm
- 2C-VDE cross slotted screwdrivers PH, size 1 + 2
- 2C-VDE screwdrivers PZ/FL, size 1 + 2
- 2C-VDE combination pliers 185 mm
- 2C-VDE diagonal cutter 165 mm
- 2C-VDE telephone pliers 200 mm
- 2C-VDE cable cutter 200 mm
- 2C-VDE water pump pliers 240 mm
- VDE cable knife, straight blade, 50 mm
- Safety glasses „PRO“
- Automatic wire stripper 0,2 - 6 mm²
- Voltage tester „TestPen“
- Voltage tester „Profi“
- Finger gloves, size 9
- Ear protection plugs
- NH-safety fuse grip



Art. no.	set	empty	kg	PU
220303	21-pieces	220076	8,680	1

Tool case "Venus Plus" 1000 V

ABSfly

rigid case, signal-red, complete with 32 safety-tools. (460 x 180 x 310 mm).

Content:

- Electrician's screwdrivers 75, 100, 150, 175, 200 mm
- Cross slotted screwdriver, PH size 1 + 2
- Cross slotted screwdriver, PZ No. 1 + 2
- VDE round nose pliers 160 mm
- VDE telephone pliers, straight, 200 mm
- VDE telephone pliers, bent, 200 mm
- VDE combination pliers 185 mm
- VDE side cutter 165 mm
- VDE wire stripping pliers 160 mm
- Retaining screwdrivers 100, 125 mm
- Retaining screwdriver cross-slotted
- Right angle allen keys, 6, 8 mm
- 2C-VDE socket wrenches 5,5, 6, 7, 8 mm
- Voltage tester "Profi"
- Cable knife, insulated
- Cable knife
- Cable scissor
- Plastic pliers 180 mm
- Self adhesive PVC tape, red, 10 m
- NH-Safety grip
- Finger gloves, size 9



Art. no.	set	empty	kg	PU
220033	32-pieces	220032	10,160	1

Tool case "HAUPA - Lifesaver" 1000 V



Aluminium case, equipped with 54 safety tools.
Size: 830 mm x 550 mm x 300 mm, weight: 37 kilos.

Content:

- 2C-VDE socket wrenches 5, 5,5, 7, 8, 10, 11, 13 mm
- Voltage-Tester
- 2C-VDE electrician's screwdrivers
2,5 x 75, 3 x 100, 4 x 100, 5,5 x 125, 6,5 x 150 mm
- 2C-VDE cross-slotted-screwdrivers PH, size 1, 2
- 2C-VDE cross-slotted-screwdrivers PZ, size 0, 1, 2
- VDE right angle-allen key 3
- VDE right angle-allen key 4
- VDE right angle-allen key 5
- VDE right angle-allen key 6
- VDE right angle-allen key 8
- VDE right angle-allen key 10
- VDE right angle-allen key 12
- VDE open-End Spanners
6, 7, 8, 9, 10, 11, 12, 13, 14, 17, 19, 22, 24, 27, 30 32
- spanner for switch-cabinets
- finger gloves, size 10
- VDE safety face mask
- VDE safety grip
- VDE electricians boots, size 42
- VDE insulating floor mat
- VDE rubber towels 600 mm
- VDE plastic clip 160 mm (2-pieces)
- Slip-on busches 10 mm (4-pieces)
- Safety belt 1400 mm
- Fallstop-breaking device and rope shortening 2 m
- VDE knife with strong blade
- VDE cable cutter 200 mm
- VDE combination pliers 185 mm
- VDE side cutter 185 mm
- VDE long chain nose pliers 200 mm
- VDE wire stripping pliers 160 mm
- VDE tweezer, pointed round 150 mm
- Fall breaking belt typ A



Art. no.	set	width	height	depth	kg	PU
220400	54-pieces	830	550	300	37,0	1
220079	empty	830	550	300	18,6	1

haupa®

... convincing solutions

HAUPA GmbH & Co. KG, Koenigstr. 165-169, 42853 Remscheid, Phone: +49 (0)2191 8418-0, Fax: +49 (0)2191 8418-840, sales@haupa.com

Installation case „Extreme“



Unloaded tool trolley, developed specifically for professionals for transporting a variety of hand tools, power tools and spare parts, making it the perfect companion. In a robust injection-moulded copolymer polypropylene case that can withstand shocks, rough use and extreme weather conditions.

Content:

- 2C-VDE cross slotted screwdrivers HUPslim PZ, size 1 + 2
- 2C-VDE cross slotted screwdrivers HUPslim PZ/FL, size 1 + 2
- 2C-VDE electricians' screwdrivers HUPslim 3,5 x 100, 4 x 100, 5,5 x 125 mm
- 2C-VDE cross slotted screwdrivers HUPslim PH, size 1 + 2
- Cable stripper
- Allround soft-grip scissors VDE
- Cable stripping knife 1000V, straight blade, 50 mm
- Automatic wire stripper, 0.08 - 6 mm²
- Combination pliers VDE 180 mm
- 2C-VDE telephone pliers, 200 mm
- Cable cutters VDE 160 mm
- Side cutters VDE 160 mm
- Cable cutter 180 mm
- Hand cable cutter Ø 32 mm
- crimping pliers 0.08 - 16 mm²
- HUPcompact „HC01“
- Insulated end sleeves 0,5, 0,75, 1,0, 2,5, 4,0, 6,0 mm²
- Insulated butt connectors 0,5-1,0, 1,5-2,5 mm²
- Insulated socket sleeves 0,5-1,0, 1,5-2,5 mm²
- Insulated ring terminals 0,5-1,0, 1,5-2,5 mm²

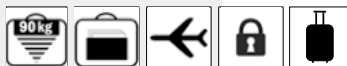

Art. no.	set	empty	kg	PU
220319	38-pieces	220311	20,200	1

Tool case trolley „Extreme“ 1000 V



Empty, waterproof and perfectly sealed thanks to the embedded neoprene O rings and pressure relief valve, this case provides absolute protection for your tools.

Content:

- 2C-VDE cross slotted screwdrivers HUPslim PZ, size 1 + 2
- 2C-VDE cross slotted screwdrivers HUPslim PZ/FL, size 1 + 2
- 2C-VDE electricians' screwdrivers HUPslim 3,5 x 100, 4 x 100, 5,5 x 125 mm
- 2C-VDE cross slotted screwdrivers HUPslim PH, size 1 + 2
- Cable stripper
- Allround soft-grip scissors VDE
- Cable stripping knife 1000V, straight blade, 50 mm
- Automatic wire stripper, 0.08 - 6 mm²
- Combination pliers VDE 180 mm
- 2C-VDE telephone pliers, 200 mm
- Cable cutters VDE 160 mm
- Side cutters VDE 160 mm
- Voltage tester "Profi LEDplus II"
- Safety fuse grips
- Finger gloves 1000 V, size 10
- Tool case 1000 V, 1/4"



Art. no.	set	empty	kg	PU
220323	22-pieces	220299	12,200	1

Hard-top tool cases

Tool case „Start-up Sanitär“

ABS

hard-side case, black, 2 tool sections, document pocket, combination lock, bottom half of case equipped with variable partitions, with high-grade fittings, 24 tools, case 220031.

Content:

- Side cutters VDE, 160 mm
- 2C-VDE telephone pliers, 200 mm
- Water pump pliers, 240 mm
- 2C-VDE electrician's screwdrivers 2,5 x 75, 4 x 100, 5,5 x 125, 6,5 x 150 mm
- 2C-VDE cross slotted screwdrivers PH 1 + 2
- Hexagon angle screwdriver set, with spherical head, 9 pcs., wrench size 1,5 - 10
- Express-Key M10
- Pipe wrenches, 430 mm, pipe 1 1/2", wrench size 59 mm
- Tube cutter, Ø 3 - 35 mm
- PUK pocket saw DIN 6473 C
- Electricians' chisel, 12 x 250 mm
- Engineers' hammer
- Paint scraper, 185 x 40 mm
- Plaster cup, Ø 125
- Water brush
- Wire brush, 300 mm
- Folding rules, wood, 2 m
- Cabinet level, 200 mm
- Carpenters' pencil, 150 mm



Art. no.	set	empty	kg	PU
220263	24-pieces	220031	9,300	1

Tool case „Start-up SHK“

ABS

hard-side case, black, 2 tool sections, document pocket, combination lock, bottom half of case equipped with variable partitions, with high-grade fittings, 57 tools, case 220031.

Content:

- 2C-VDE Side cutters, 200 mm
- 2C-VDE telephone pliers, 200 mm
- Water pump pliers, 240 mm
- Pipe wrenches, 430 mm, pipe 1 1/2", wrench size 59 mm
- Express-Key M10
- Switch cabinet key, „HUPkey“ with converting bit
- 2C-VDE electrician's screwdrivers 3,5 x 100, 5,5 x 125 mm
- 2C-VDE cross slotted screwdrivers PH 1 + 2
- 2C-VDE screwdrivers Tx 15, 20, 25
- Socket set 1/4", 33 pcs.
- Double ended spanners DIN 3110, wrench size 10 - 11
- Double ended spanners DIN 3110, wrench size 12 - 13
- Utility metal knives
- Hexagon angle screwdriver set, with spherical head, 9 pcs. wrench size 1,5 - 10
- VDE/GS-Voltage testers, 120 - 250 V, loose
- Engineers' hammer
- Stone chisels, octagonal shank, 28 x 250 mm
- Aluminium spirit levels, 400 mm
- Tube cutter, Ø 3 - 35 mm
- Micro pipe cutter, Ø 3 - 16 mm



Art. no.	set	empty	kg	PU
220264	57-pieces	220031	12,800	1

Laser marking

Attractive laser marking for your individual tool case

Show profile - give your tool case your name! Logo and name in noble laser design on aluminium plate.

You decide where it's placed!



Art. no.	kg	PU
220193	0,020	1

Assortment boxes

Assortment boxes with metal catch and pick boxes

black plastic, including pick boxes

Content:

- 6 Boxes (S) | 49 x 49 x 72 mm
- 11 Boxes (M) | 49 x 98 x 72 mm
- 2 Boxes (L) | 98 x 98 x 72 mm
- 2 Boxes (XL) | 98 x 148 x 72 mm



Art. no.	width	depth	height	kg	PU
221131 *	415	335	90	21-pieces	1,500
221133	415	335	90	empty	1,200

SysCon - Systemcontainer





HAUPA SysCon product profile:

The basic idea behind the System Container is that the individual containers can be connected to each other to enable easy transport thus ensuring that simple access is provided to the contents of all containers. The containers may be offered in an empty state or with contents. If sold with contents, the contents should encompass assortments which include connection materials, fixture materials and tools.

In addition, the System Container should also acts as a transportation method of HAUPA Smart Hydraulics since the stacking concept enables the hydraulic pressing tools to be organised along with the appropriate cable lugs thus forming a system unit.

The four conical feet on the uppermost container are automatically guided into the correct position on the container below. The connection of the containers is made without expenditure of force, simply by placing them on top of one another: The snap closures on the side mean that the containers can be separated just as easily. The closures are pulled gently outwards which enables lifting.

When stacking, the container handles may be extended or folded in.

The design of the container ensures that water cannot enter the container.

Quality profile:

In order to ensure maximum stability, the containers are made from ABS. ABS is capable of withstanding both high and low temperatures without distorting or breaking.

The hard tests under a variety of conditions:

Fall tests with both empty and filled containers, stress tests, bounce tests and tensile tests have proved the robustness of the container and of components such as handles, closing flaps, snap closures etc. →

Target group:

Due to the high quality and the extreme robustness afforded by this product, the target users are professionals: Trade - Industry - Laboratories, etc.



Test simulation	Temperature	Fall height	Explanation/Observation
Fall test (empty)	+20° - 10°C	0,5 m	no damage to the product
		1,0 m	no damage to the product
		1,5 m	no damage to the product
		2,0 m	no damage, but the snap closures and closing flaps opened up
		2,5 m	minor break on the lid of the inner housing where the lid closes on the underside



Test simulation	Temperature	Fall height	Explanation/Observation
Ultimate stress test (Box closed)	+20° - 10°C	2,0 m	no damage to the product



Test simulation	Temperature	Fall height	Explanation/Observation
Fall test (Content 5 kg)	+20° - 10°C	0,5 m	no damage to the product
		1,0 m	no damage to the product
		1,5 m	no damage, but the snap closures and closing flaps opened up
		2,0 m	no damage, but the snap closures and closing flaps opened up



Test simulation	Temperature	Jump height	Explanation/Observation
Bounce test (90 kg)	+20° - 10°C	0,3 m	It is not possible to destroy the product by this test.



Test simulation	Temperature	Content	Explanation/Observation
Handle	+20° - 10°C	60 kg	No damage to the handle
		70 kg	no damage, but the snap closures and closing flaps opened up



Test simulation	Temperature	Content	Explanation/Observation
Snap closures and closing flaps	+20° - 10°C	60 kg	No damage to the snap closures No damage to the closing flaps
		70 kg	no damage, but the snap closures and closing flaps opened up

Systemcontainer

ABS plastic box „SysCon S“



outer dimensions: 464 x 353 x 142 mm
inner dimensions: 400 x 300 x 80 mm

without inlay



Art. no.	width	depth	height	kg	PU
220370	400	300	80	2,200	1

SysCon transport system



for simple and flexible transportation of HAUPA ABS SysCon plastic boxes

- SysCon lockable thanks to lateral snap latches on the transport system
- Metal plate with 4 castors, 2 lockable
- Max. load: 200 kg



Art. no.	width	depth	height	kg	PU
220653	470	240	105	3,300	1

ABS plastic box „SysCon M“



outer dimensions: 464 x 353 x 212 mm
inner dimensions: 400 x 300 x 150 mm

without inlay



Art. no.	width	depth	height	kg	PU
220372	400	300	150	2,600	1

Take a look at our SysCon crash test on YouTube!

SysCon Crashtest



ABS plastic box „SysCon XL“



outer dimensions: 464 x 335 x 362 mm
inner dimensions: 400 x 300 x 312 mm

without inlay



Art. no.	width	depth	height	kg	PU
220650	400	300	312	2,800	1



SysCon for assortment inserts empty



Content:

1	220370	ABS plastic box „SysCon S“
2	220376	Foam insert "SysCon" 395 x 300 x 15 mm
24	221135	Box M



Art. no.		kg	PU
220620	empty	2,800	1

SysCon M for assortment inserts empty



Content:

1	220372	ABS plastic box „SysCon M“
1	220374/S	Assortment insert SysCon with foam
1	220399	Foam "SysCon" 395 x 300 x 10 mm
14	221135	Box M
2	221136	Box L
2	221137	Box XL



Art. no.		kg	PU
220770	leer	3,000	1

SysCon for assortment inserts, empty



Content:

1	220370	ABS plastic box „SysCon S“
2	220376	Foam insert "SysCon" 395 x 300 x 15 mm
14	221135	Box M
2	221136	Box L
2	221137	Box XL



Art. no.		kg	PU
220628	empty	2,900	1

SysCon tool box empty



Content:

1	220372	ABS plastic box „SysCon M“
1	220399	Foam insert "SysCon" 300 x 395 x 10 mm
1	220374	Tools insert "SysCon"
1	220379	Tool plate "SysCon" 11 compartments



Art. no.		kg	PU
220622	empty	2,400	1

SysCon tool box empty

SysCon

Content:

1	220370	ABS plastic box „SysCon S“
2	220377	Foam insert "SysCon" 395 x 300 x 20 mm
1	220406	Tools insert "SysCon"



Art. no.	width	depth	height	kg	PU
220626	empty	400	300	2,500	1

Tool plate

SysCon

adjustable inner divider, with 10 tool straps, matching for Art. 220654, dimensions: 275 x 285 mm



Art. no.	width	height	kg	PU
220655	275	285	empty	0,200 1

Tool plate SysCon

SysCon

11 compartments, for mounting in a SysCon lid



Art. no.	width	depth	height	kg	PU
220379	400	300	20	0,200	1

ABS plastic box „SysCon XL“ variable

SysCon

outer dimensions: 464 x 335 x 362 mm
inner dimensions: 400 x 300 x 312 mm

incl. tool plate and adjustable inner divider



Art. no.	width	depth	height	kg	PU
220654	empty	400	300	312	4,300 1

Foam insert SysCon



soft foam, 395 x 300 x 10 mm

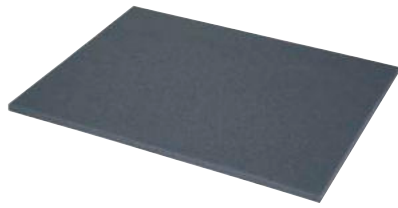

Art. no.	width	depth	height	kg	PU
220399	395	300	10	0,020	1

Foam insert SysCon



soft foam, 395 x 300 x 15 mm



Art. no.	width	depth	height	kg	PU
220376	395	300	15	0,030	1

Foam insert SysCon



rigid foam, 395 x 300 x 20 mm



Art. no.	width	depth	height	kg	PU
220377	395	300	20	0,055	1

Foam insert SysCon



rigid foam, 395 x 300 x 65 mm



Art. no.	width	depth	height	kg	PU
220378	395	300	65	0,200	1

Tools insert SysCon



Polypropylen, 5 compartments



Art. no.	width	depth	height	kg	PU
220374	400	300	80	0,200	1

Tools insert SysCon



Polypropylen, 10 compartments



Art. no.	width	depth	height	kg	PU
220375	400	300	80	0,200	1

Tools insert SysCon



Polypropylen, 18 compartments



Art. no.	width	depth	height	kg	PU
220355	400	300	80	0,200	1

Tools insert SysCon



Polypropylen, with 12 adjustable compartments



Art. no.	width	depth	height	kg	PU
220356	400	300	80	0,200	1

Systemcontainer

Box S



ABS, conical design for stacking with snap on base plate



Art. no.	width	depth	height	kg	PU
221134	49	49	72	0,020	1

Box M



ABS, conical design for stacking with snap on base plate



Art. no.	width	depth	height	kg	PU
221135	98	49	72	0,031	1

Box L



ABS, conical design for stacking with snap on base plate



Art. no.	width	depth	height	kg	PU
221136	98	98	72	0,048	1

Box XL



ABS, conical design for stacking with snap on base plate



Art. no.	width	depth	height	kg	PU
221137	148	98	72	0,065	1

Baseplate for fixing



Polypropylene, grids for even better non-slip grip

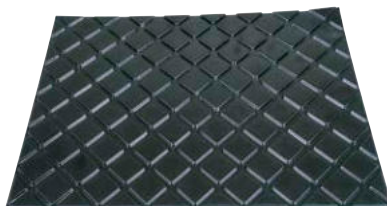

Art. no.	width	depth	kg	PU
221138	400	300	0,100	1

SysCon hand truck



Properties:

- up to 60 kg
- sturdy aluminum frame
- Hand truck shovel: 390 x 280 mm

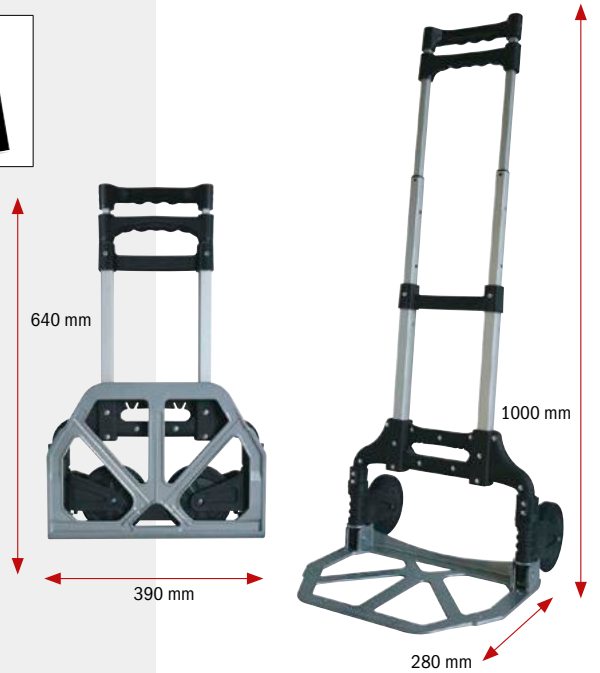

Art. no.	max.kg	kg	PU
220602	60	2,500	1

SysCon load securing "SysConCar"



Properties:

- 21 slots (rear side)
- 3 round holes each side, left and right
- 5 round holes in floor plate
- Width: 475 mm, height: 1080 mm, depth: 360 mm
- Volume for contents:
 - max. 5 ABS boxes „SysCon M“
 - max. 8 ABS boxes „SysCon S“



Art. no.	width	depth	height	kg	PU
220644	475	360	1080	5,000	1

SysCon tool case set



Content: 17 tools

- 1 220372 ABS plastic box "SysCon M"
- 1 220374 Tools insert "SysCon"
- 1 220399 Foam "SysCon" 400 x 300 x 10 mm
- 1 220379 Tool plate "SysCon" 11 compartments

- 210696 Spanner for switch-cabinets
- 210695 Automatic wire stripper 0,2 - 6 mm²
- 263842 VDE electrical tape 19 mm x 20 mm, black
- 263844 VDE electrical tape 19 mm x 20 mm, white
- 263860 VDE electrical tape 19 mm x 20 mm, green/yellow
- 200031 Cable stripping knife 8 - 28 mm²
- 211200 2C-VDE combination plier DIN 5244, 185 mm
- 211204 2C-VDE side cutter DIN 5238 B, 165 mm
- 211208 2C-VDE telephone plier DIN 5236 A, 200 mm, straight
- 101870 2C-VDE screwdriver PZ/FL 1
- 101872 2C-VDE screwdriver PZ/FL 2
- 181910 2C-VDE screwdriver 2,5 x 75 mm
- 101914 2C-VDE screwdriver 3,5 x 100 mm
- 101916 2C-VDE screwdriver 4,0 x 100 mm
- 101920 2C-VDE screwdriver 6,5 x 150 mm
- 101942 2C-VDE screwdriver PH1
- 101944 2C-VDE screwdriver PH2



Art. no.	set	empty	kg	PU
220392	17-pieces	220372	4,300	1

SysCon tool case set "Start VDE"



Content: 22 tools

- 1 220372 ABS plastic box "SysCon M"
- 1 220374 Tools insert "SysCon"
- 1 220399 Foam "SysCon" 400 x 300 x 10 mm
- 1 220379 Tool plate "SysCon" 11 compartments

- 240042 Aluminium spirit levels 400 mm
- 180184 Engineers' hammer 300 g
- 210695 Wire stripper Super Plus 0,2 - 6 mm²
- 200043 Universal stripper 0,2 - 4 mm²
- 211200 2C-VDE combination pliers DIN 5244, 185 mm
- 211217 2C-VDE heavy duty side cutters DIN 5238 A, 170 mm
- 211208 2C-VDE telephone pliers DIN 5236 A, 200 mm, straight
- 101999 2C-VDE screwdrivers set
- 101870 2C-VDE screwdriver with PZ slot profile PZ/FL 1
- 101872 2C-VDE screwdriver with PZ slot profile PZ/FL 2
- 180092 Electricians' chisels 10 x 250 mm
- 100647 Voltage tester VDE/GS
- 150090 Carpenters' pencil
- 150024 Paint scrapers 40 mm
- 150004 Water brushes
- 240002 Folding rules 2 m
- 150006 Plaster cup



Art. no.	set	empty	kg	PU
220608	22-pieces	220372	6,500	1

HUPchemie



haupa[®]
... convincing solutions

Construction Glue HUPfix+



Application HUPfix+:

Gluing of metal, wood and synthetic materials in electrical sectors, building, furniture manufacture, container construction, metal work, machinery, air conditioning, yacht/boat construction, body-work, vessel construction and construction of window and door frames. Suitable in applications where silicones can not be used. An adhesive with a grab and bond strength so good it can be classed as the ultimate performance adhesive. With HUPfix+ it is possible to glue heavy materials like cables, stone, wood, tiles and metals on ceilings and walls, where other common glues fail.

Characteristics:

The materials which needs to be glued, must be clean, free of oil and grease. Apply the HUPfix+ on one side, place the material to be glued together and press firm. Direct adhesion. Skinning time after 10 till 20 minutes. Curing 3 mm/24 hours. Shelf life: 12 months. Temperature resistance: -40 till +100°C (130°C short-term up to 2-3 hours). Application temperature: +5 till +40°C.



Art. no.	ml		kg	PU
170206 *	310	Adhesion+Sealing	0,450	1

MS-Polymer HUPfix

How to use HUPfix:

HUPfix is a high-quality adhesive and sealant with an MS polymer base. UV, weather, saltwater and chlorine resistant. Very good adhesion to many surfaces, in most cases, without primer. Hardens quickly. The join must be smoothed immediately after application using acid-free soapy water.

Properties:

Temperature resistant from -40 to +100°C. Processing temperature +5 to +40°C. HUPfix can be used both as adhesive and for grouting. Can be painted.



Art. no.	ml		colour	kg	PU
170216	310	Adhesion+Sealing	transparent	0,300	1
170210	310	Adhesion+Sealing	grey	0,440	1
170212	310	Adhesion+Sealing	black	0,440	1
170214	310	Adhesion+Sealing	white	0,440	1



HUPsilicon

How to use HUPsilicon:

For grouting indoors and outdoors, window glazing and sealing of joints in wood, plastic and aluminium windows. Corresponds to DIN 18545 Part 2. Very good adhesion on the majority of usual varnishes and paints.

Properties:

Permanently elastic. Aging, weather and UV resistant. Odour neutral. No early crack formation. Good adhesion on worktops. No surface stickiness. Temperature resistant from -50°C to +150°C. Processing temperature +5°C to +40°C. Skin formation time approximately 10-15 minutes (at 23°C).



Art. no.	ml	colour	kg	PU
170200	310	Adhesion+Sealing transparent	0,450	1
170202	310	Adhesion+Sealing white	0,450	1

High temperature silicon HUPsilicon

How to use HUPsilicon:

For sealing joints and surfaces in temperature-critical areas (extreme cold and heat). Can be used as coating for solid seals. For sealing drive axle covers, inlet systems, differential covers, gear, front and camshaft bearing covers, thermostat housings, oil pumps, oil tanks, spur-wheel covers, spotlights and street lighting, windscreens, water pumps etc. (not suitable for adherence to PP, PE, Teflon® and bitumen surfaces, or for parts constantly exposed to solvents)

Properties:

Sealing and adhesive mass with a silicone base. Heat stabilised, excellent resistance to UV and weather influences as well as to motor and gear oils, resistant to chemicals, mechanical and environmental influences, resistant to water, salt water, cold, heat, very high flexibility and good adherence on almost all surfaces. Colour: Black. Skin formation time: 10 minutes. Temperature resistance: -40° to +260°



Art. no.	ml	colour	kg	PU
170250	310	black	0,450	1

Cartridge tip

for 310 ml cartridges



Art. no.	kg	PU
300116	Adhesion+Sealing 0,003	1

Cartridge gun „Profi“

for 310 ml cartridges

- for processing silicone and polymer cartridges



Art. no.	kg	PU
170254	Adhesion+Sealing 0,450	1

2 Component High-Performance-Adhesive HUPmega

How to use HUPmega:

Gluing of metal, stone, ceramics, wood and plastic. Simple to use. Extremely high durability. HUPmega is mixed automatically. Within 4 minutes, combine the pieces and wait 24 hours to harden (approximately 75% of the final hardness will be achieved after 2 hours at room temperature).

Properties:

Temperature-resistant: -55°C to +120°C
 Open time: approximately 5 minutes
 Mechanical processing: After approximately 30 minutes
 Final hardness: After 24 hours
 Processing temperature: from +10°C to +30°C
 Weather-resistant, good media resistance
 Storage temperature +6°C to maximum +28°C



Art. no.	ml	kg	PU
170220	25	Adhesion+Sealing 0,050	1

Mixing nozzle

- for 2-component adhesive



Art. no.	kg	PU
170234	Adhesion+Sealing 0,003	1

2 Component-epoxyd glue HUPepoxyd

How to use HUPepoxyd:

Gluing of metal, (hard) plastic, ceramics, glass, porcelain, stone, wood, concrete, rubber and much more. Ideal for gluing tasks with high visual requirements. Clean the surfaces to be glued, open the cap and screw the mixing nozzle into place. Dispose of the first 2 g since this will not be mixed 1:1. Then apply the glue and join the parts. Remove the mixing nozzle and dispose it. Replace the cap. Store open cartridges in a cool place and use as soon as possible (you can also work without the nozzle).

Properties:

Temperature resistant: -40°C to +80°C. Processing temperature: +10°C to +30°C. Final hardness: 24 hours. Open time: approximately 5 minutes.



Art. no.	ml		kg	PU
170222	25	Adhesion+Sealing	0,025	1

2 Component liquid metal HUPfastMetal

How to use HUPfastMetal:

Repair of cracks, drill holes, holes etc. Suitable for extremely strong adhesion of metal and metal alloys (steel, aluminium). Clean the surfaces to be glued, open the cap and screw the mixing nozzle into place. Dispose of the first 2 g since this will not be mixed 1:1. Then apply the glue and join the parts. Remove the mixing nozzle and dispose it. Replace the cap. Store open cartridges in a cool place and use as soon as possible (you can also work without the nozzle).

Properties:

Temperature resistant: -50°C to +120°C, Open time approximately 5 - 10 minutes. After approximately 30 minutes, you will be able to mechanically process the repaired location.



Art. no.	ml		kg	PU
170224	25	Adhesion+Sealing	0,025	1

HUPsuperglue

How to use HUPsuperglue:

The surfaces must be clean and free of oil or grease. Apply a thin layer of HUPsuperglue to one side and join the parts.



Art. no.	ml		kg	PU
170226 *	20	Adhesion+Sealing	0,020	1

Fine droplet tip



Art. no.			kg	PU
170236	Adhesion+Sealing		0,001	1

Double-Sided Acryl Tape

HUPtapeDouble

How to use HUPtapeDouble:

Permanent and safe hold on almost all smooth surfaces such as metal, wood, glass, plastic, ceramics and rubber. Ideal for mounting brackets, signs, hooks, shelf elements, etc.

Not suitable for: PE, PP, PTFE (e.g. Teflon®), silicone, paper and vinyl wallpaper, non-load-carrying surfaces as well as surfaces with dirt-repelling coatings.

Properties:

HUPtapeDouble is an extremely strong, double-sided sticky tape. For durable adhesion, installation and securing both indoors and outdoors. Load up to a maximum of 1.3 kg.

Transparent. Surfaces are not damaged. Moisture resistant.

Used in dry, clean and well-aired areas with temperatures of +10°C to +30°C.



Art. no.			kg	PU
170232	Adhesion+Sealing		0,050	1

Screw-Locking Medium-Strength HUPlockM

How to use HUPlockM:

For all screws with threads up to M36.
Extremely viscous, medium hard, can be removed.

Properties:

Hand-tight: 10 - 20 minutes
Functionally-tight: 1 - 3 hours
Temperature resistant: -55 to +150°C



Art. no.	ml		kg	PU
170238	50	Adhesion+Sealing	0,050	1

Screw-Locking High-Strength HUPlockH

How to use HUPlockH:

For all screws with threads up to M20.
Medium viscosity, extremely durable, difficult to remove.

Properties:

Hand-tight: 10 - 20 minutes
Functionally-tight: 1 - 3 hours
Temperature resistant: -55 to +150°C



Art. no.	ml		kg	PU
170240	50	Adhesion+Sealing	0,050	1

Anti-Friction-Coating HUPcable

Application HUPcable:

Spray the prepared cable. Wait for the propellant gas to evaporate (a few seconds) then pull in the cable.

Properties:

HUPcable simplifies pulling of cable into the protective hose.



Art. no.	ml		kg	PU
170174 *	400	Coating+Lubrication	0,450	1

Water-based lubricants and slip agents

This prevents 80% of friction and facilitates cable laying through excellent slippage in every situation. As soon as the water is evaporated, the main part of the lubricant remains und and ensures that old cables can easily be pulled out and new ones inserted, for many years and at different temperatures.

Gel lubricant art. 143344: plastic bottle 500 ml
Gel lubricant art. 143345: plastic bottle 1.000 ml



Art. no.		kg	PU
143344	plastic bottle 500 ml	0,572	1
143345	plastic bottle 1.000 ml	1,150	1

Dispenser for plastic bottle



Art. no.		kg	PU
143346	Coating+Lubrication	0,016	1

Water-based lubricants and slip agents

This prevents 80% of friction and facilitates cable laying through excellent slippage in every situation. As soon as the water is evaporated, the main part of the lubricant remains und and ensures that old cables can easily be pulled out and new ones inserted, for many years and at different temperatures.

Foam lubricant, spray can 400 ml



Art. no.		kg	PU
143348	spray can 400 ml	0,457	1



Aluminium-Spray HUPalu

Application HUPalu:

For servicing and maintaining the value of machine parts, for processing of machines, furnaces, heating and steam systems, pipes, exhaust systems, turbines, etc., as a container protection, coating for wheels, trucks bodies and much more.

Properties:

HUPalu pure aluminum spray 99.5%, heat resistant up to 900°C, anti-corrosive and high-temperature-resistant, scratch-, brushing and abrasion resistant, weather resistant.



Art. no.	ml		kg	PU
170154	400	Coating+Lubrication	0,450	1

Marking Paint HUPmark

Application HUPmark:

The area to be sprayed must be dry, clean and grease-free. Bring the can up to room temperature. Before use and after each pause in spraying, shake well until the mixing ball moves freely. After use, spray out upside down.

Properties:

Marking spray for industrial, craft, construction and mining etc. For fast, clean and permanent marking of: Cement, wood, masonry, metal, asphalt, soil, plaster, glass, ceramics etc. For labelling and marking of: Pavements and roads, construction measures, breakthroughs, pipe and cable ducts, free from heavy metals, lead and cadmium, dries quickly and is friction and waterproof.

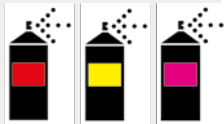

Art. no.	ml	form	colour	kg	PU
170140	500	Coating+Lubrication	luminous red	0,550	1
170141	500	Coating+Lubrication	luminous yellow	0,550	1
170142	500	Coating+Lubrication	luminous pink	0,550	1

Zinc-Spray HUPzinc

Application HUPzincDark:

For rectification of hot-dip galvanized parts, subsequent protection after welding, to repair damaged surfaces, corrosion protection by galvanic effect, protective coating for pipes and metals, primer for subsequent coats. Forms a durable protective layer with water-insoluble Zinc oxide, iron (steel) and thus protects also defective places.

Properties:

HUPzinc is a mixture of high-purity zinc and aluminum powder, heat resistant, weather-resistant and quick-drying.

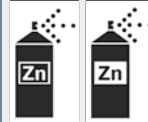

Art. no.	ml		colour	kg	PU
170150	400	Coating+Lubrication	Dark	0,450	1
170152 *	400	Coating+Lubrication	Light	0,450	1

Zinc spray 550 HUPzincKorro

How to use HUPzincKorro:

Shake the container well until the mixing ball is clearly audible and the contents are well mixed. Clean the surface to be treated with the wire brush, or even better sand blast it. The surface must be grease-free and clean. The best processing temperature is from 16-32 °C. For optimum results apply the spray from a distance of 25-30 cm with short motions. For commercial use only. Carry out preliminary tests for effectiveness and material compatibility.

Properties:

The employed zinc and zinc compounds contain more than 99% pure zinc, cross-cut adhesion tested in accordance with DIN EN ISO 2409, heat-resistant up to 500 °C, mandrel bend tested in accordance with DIN EN ISO 1519, salt spray tested in accordance with DIN 50021, subsequent protection after welding work for repairing damaged surfaces, protective coating for pipelines and metals, forms a permanent protective coating with water-insoluble zinc oxide on iron (steel) and thus also protects faulty points.



Art. no.	ml		kg	PU
170153	400	Coating+Lubrication	0,450	1



Stainless-Steel-Spray HUPInox

Application HUPInox:

For maintenance and repair, maintaining the value of stainless steel, for processing of pipes, machinery, truck bodies, silos, turbines, etc., as a container and tank system protection and much more.

Properties:

HUPInox stainless steel coating, alloy, consisting of chrome >15%, nickel >7%, manganese >1%, heat resistant to 300°C, protects against corrosion, durable and weather-resistant protective layer, good and secure adhesion to metal, wood, glass, stone and much more.



Art. no.	ml	kg	PU
170156	400	0,450	1

Silicone-Spray HUPsil

Application HUPsil:

In order to eliminate creaking, squeaking and running noise of machines, vehicles, chains. As a lubricant, and as anti-aging. To clean, care and protection of metals, rubber and plastic, for retracting of rubber and plastic profiles, etc.

Properties:

HUPsil is a universal silicone spray and lubricant. It is waterproof, weather and temperature-resistant from -30°C to +200°C. It acts antistatic and dust repellent, lubricates and waterproofs all surfaces without being greasy, anti-corrosive and moisture-resistant.



Art. no.	ml	kg	PU
170162	400	0,450	1

Universal-Lubricant HUP40

Application HUP40:

Loosens persistent fittings, nuts, bolts, etc. due to rust and oxidation, removes moisture and condensation on cables and electrical connections and contacts, is based on an ultra-thin film which protects all metal surfaces and prevents further corrosion, keeps moisture from cables and contacts and prevents further accumulation of moisture, Lubricates cars and protects tools, machines, precision instruments, locks, sliding and guiding rails, wheels, bolts, hinges, fittings, etc.

Silicone free! It even melts ice on locks, bolts, hinges, fittings, etc.

Properties:

HUP40 high quality universal spray with 1001 solutions!



Art. no.	ml	kg	PU
170166	400	0,450	1

PTFE-Spray HUPptfe

Application HUPptfe:

Anywhere where oil- and grease coatings are unwanted. The special lubricant for all maintenance-free gliding lubrications, protects all metals, leather and wood parts - anti-aging for rubber parts, seals and plastics.

To eliminate creaking, squeaking and running noise of machinery, chains, windows, doors, trays, etc. In the electro-, plastics-, wood-, paper- and textileindustrie. Water-resistant coating of paper, cork and textiles.

Properties:

HUPptfe Oil-free Dry Lubrication Spray. High temperature resistant surface protection from -60 °C to +250°C with long-term effect and low coefficient of friction, quick drying, highly adhesive, grease-free and colorless, tasteless after application, the protection film seems anti-corrosive and moisture repellent.



Art. no.	ml	kg	PU
170158	400	0,450	1

Allround PTFE-Spray HUPptfeSynt

Application HUPptfeSynt:

Especially for long-lasting lubrication under very strong pressure and frictional conditions. It protects all moving parts and prevents snagging, creaks and squeaks.

Properties:

HUPptfeSynt for lubrication of precision, such as pressure-loaded parts in an enormously wide range of temperatures.



Art. no.	ml	kg	PU
170160	400	0,450	1

Polymer-Spray HUPpolymer

Application HUPpolymer:

Substitute for silicone spray as a retraction, sliding and lubricating aid, as well as long-term care for rubber, EPDM, PP, PVC etc. Significantly improved gliding characteristics on coated surfaces - the coefficients of friction are reduced up to 40%. Treated surfaces have a color-intensifying appearance. Coated surfaces are water-resistant, insensitive to contamination, further processing (gluing, painting, printing, etc.) of adjacent materials without having trouble.

Properties:

HUPpolymer contamination of tools and manufactured parts, which can occur when using silicone oils, are avoided. No stress cracking when in contact treated profiles with plexiglas or polycarbonate.



Art. no.	ml	kg	PU
170170	400	0,450	1

Cutting-Oil HUPdrill

Application HUPdrill:

Targeted and clean to use when cutting, very economical and efficient in consumption. For machines, for which the complete separation of the coolant from the hydraulic oil used or lubricating oil is not present. Suitable for the treatment of iron and non-ferrous metals.

Properties:

HUPdrill special cutting oil, transparent. Alloyed oil contains highly effective EP-Additives and polar substances, elastic film of lubricant with corrosion protection, high loads through sustainable boundary layer formation, high load carrying capacity.

Provides low-wear operation with corrosion protection.



Art. no.	ml		kg	PU
170172	400	Coating+Lubrication	0,450	1

Anti-Rust-Spray HUPrustEX

Application HUPrustEX:

Penetrates the rust, removes oils, resins, tar and oil coal, solves persistent connections easily, eliminates rattles and squeaks protects the long term, penetrates even constrictions and facilitates the disassembly of parts. Triggers stuck screw, brings all corroded connections, such as screw, nuts, bolts, joints moving again.

Properties:

HUPrustEX penetrates and dissolves extremely effective rust, preserves and protects against new rust attack by a MoS2 protective film.



Art. no.	ml		kg	PU
170164	400	Coating+Lubrication	0,450	1

Contact spray HUPwetBlock

Application HUPwetBlock:

Due to its highly effective ingredients all types of electrical contacts and connections are protected against moisture and corrosion. Water and moisture is reliably suppressed. The product properties remain even after several months of use indoors and also outdoor and prevent permanent leakage currents and short circuits in: lighting systems, connections and sockets, electrical machinery and equipment, pumps, intercom systems, switches and fittings, connectors and contacts sockets, fuse boxes, cable connections, cable reels, battery terminals, engine electrical, electric, bell systems and much more.



Art. no.	ml		kg	PU
170180	400	Coating+Lubrication	0,450	1

Fast degreaser HUPdegreaser

Application HUPdegreaser:

For cleaning and degreasing of dust, dirt, oil, mechanical parts. For removing wax-stains, fats and resins from high potential switches, air conditioning, antenna insulators, motors, ventilators, switchboards, cables, stubborn dirt on glass and car paint, etc.

Properties:

HUPdegreaser is a quick and intensive degreaser and cleaner for mechanical and electrical equipment. Residue-free and fast evaporating.



Art. no.	ml		kg	PU
170102	500	Cleaning	0,600	1



Electric-Engine-Cleaner HUPelectroClean

Application HUPelectroClean:

It is used to remove dust, dirt, oil, grease, lubricants and coal dust to electromechanical contacts, relays, wires, distributors, coils, etc. Can also be used for pre-cleaning for subsequent painting.

Properties:

HUPelectroClean consisting of a mixture of hydrocarbons and cleaning boosters. Cleans spot and streak free and evaporates without residue after cleaning.



Art. no.	ml		kg	PU
170114	400	Cleaning	0,450	1

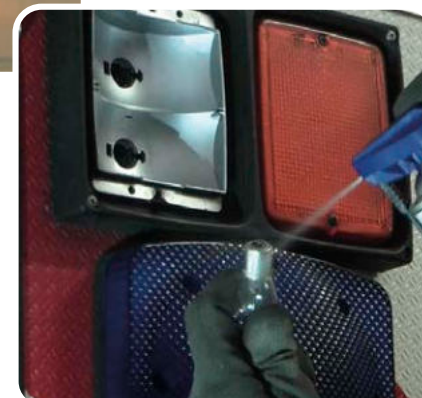
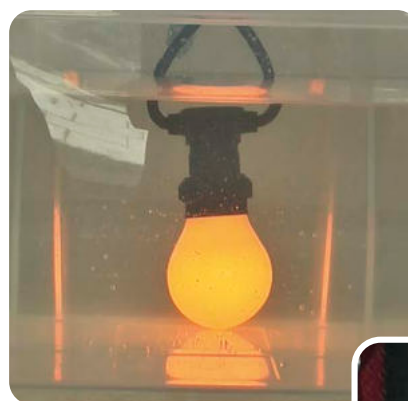

**Multi Cleaner
HUPcleanMulti**

Application HUPcleanMulti:
Cleaning of windows, mirrors, glass, monitors, plastic-surfaces, tiles, etc. in industry and crafts.

Properties:
HUPcleanMulti is a Multi-Foam with orange aroma. Intensive cleaner, for a sparkling shine on all surfaces. Powerful, yet mild. Very economical due to high concentrate, skin-sensitive. Spotless, non-porous, streak-free. Cleans with active-foaming effect.



Art. no.	ml		kg	PU
170104	500	Cleaning	0,550	1

**Metal Degreaser
HUPmetalClean**

Application HUPmetalClean:
Removes coarse contamination mechanically. Spray from a short distance and allow the cleaning agent to run off. The parts to be cleaned are clean and dry in just a few seconds. Parts do not need to be removed if the dissolved contaminations are able to run off with the fluid.
Note: Does not attack enamelled paints/Not suitable for plastic and seals! Only for commercial use. Carry out tests for effect and material compatibility.

Properties:
For powerful quick cleaning, residue-free and rapid evaporation, removes grease, oil, wax residue, Edding, felt-tip and ball-point pen, resin and stubborn contaminations from all metal surfaces.
For residue-free degreasing of all metal objects, but may also be used as cleaner for subsequent painting of gluing.



Art. no.	ml		kg	PU
170103	500	Cleaning	0,600	1

Foam Cleaner HUPclean



Application HUPclean:
For cleaning windows, monitors, plastic surfaces, buildings, vehicles and machines.

Properties:
HUPclean is a multifunctional cleaner and achieves best levels of cleanliness on cases of fouling by oil, grease, wax and similar substances.



Art. no.	ml		kg	PU
170100	500	Cleaning	0,550	1
170101	1000	Cleaning	1,050	1

**Label-Remover
HUPlableEx**

Application HUPlableEx:

Residue-free removal of adhesive residues, labels, lubricants, bitumen, fresh PU foam residues and stubborn stains. For cleaning of metal surfaces (even before painting) suitable in many areas of industry, trade and craft.

Properties:

HUPlableEx is powerful, yet gentle on the material, evaporates quickly and leaves no residue.



Art. no.	ml		kg	PU
170112	400	Cleaning	0,450	1

Dosage cap „Target Control System“

The „Target Control System“ is a stable, flexible dosage cap that can be removed at any time. It is compatible with many of the HAUPA aerosol products („parent valve“/star). This means even more accurate, precise spraying and dosage. Targeted, accurate and properly dosed. Not for sprays art: 170106, 170150, 170152, 170400



Art. no.		kg	PU
170406	Cleaning	0,020	1

Compressed Air HUPair

Application HUPair:

HUPair compressed air for cooling and debugging overheated parts. To remove dust, dirt and other deposits on computers, Keyboards, engineering components, office equipment, photocopiers, printers etc.



Art. no.	ml		kg	PU
170106 *	400	Cleaning	0,450	1

HUPskinProtect

Application HUPskinProtect:

Protects hands and other parts of the body by a protective film prior to contact with the oil, grease, tar, paint, dust, and other dirt and pollutant species. It can prevent allergic reactions with many substances, because a protective film between the skin and the medium is established. For daily use in the industrial and craft.

Properties:

HUPskinProtect facilitates skin cleaning. The skin remains breathable and does not dry out. Dermatologically tested.



Art. no.	ml		kg	PU
170116	250	Cleaning	0,300	1

**Compressed Air non-flammable
HUPairXtra**

Application HUPairXtra:

Is used anywhere where dust and loose dirt is only removed with difficulty. In the entire range of maintenance and repair of electronic equipment, components, computers, precision mechanical watches, etc. For dust and dirt removal on keyboards, computer cases, cabinets, measuring and control technology instruments, optical instruments, hi-fi and video equipment, as well as modules, printed circuit boards, magnetic heads, drives, etc.

Properties:

HUPairXtra non-flammable - especially good for suitable cleaning of electrical contacts. For a clean and dry cleaning in hard to reach places and on delicate surfaces.



Art. no.	ml		kg	PU
170108	400	Cleaning	0,450	1

**Cleaning Wipes
HUPwipe**

Application HUPwipe:

HUPwipe is the ideal aid for removing stubborn. Contaminants such as: rust, grease, adhesive residue, oil, soot, resins, Edding lines, fresh paint residues, lubricants, nicotine and more. Can be used to remove the heaviest soiling in commercial, industrial and craft.



Art. no.	ml		kg	PU
170118	80	Cleaning	1,000	1

**Hand cleaning cream
HUPsoap, 500 ml**

Application HUPsoap:

Rub some grams on dry hands, add some water and wash thoroughly. Reduce the consumption with the corresponding dosing dispenser.

Properties:

HUPsoap Special cleaning cream for the removal of stubborn dirt e.g. fresh paint and adhesive residues, oils, grease, tar, bitumen, resins etc.



Art. no.	ml		kg	PU
170126	500	Cleaning	0,600	1
170127	3000	Cleaning	3,300	1
170128	10000	Cleaning	10,500	1

Dispenser for hand cleaning cream HUPsoap, 3l

- compatible for art. 170127
- Stainless steel tube

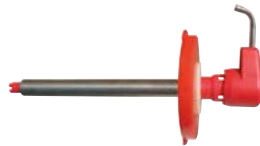

Art. no.	ml		kg	PU
170129	3000	Cleaning	0,500	1

Industrial cleaning wipes HUPwipeMini



HAUPA Industrial cleaning wipes are **perfect for washing hands as well as cleaning tools and work surfaces**. They remove stubborn dirt fast and efficiently such as grease, paint, oil, tar, ink, silicone, glue and much, much more making them the **ideal companions for workshops, offices, home or for those on the go**. These practical wipes have been impregnated with a solvent-free, industrial hand cleaner, which has been dermatologically tested and is also suitable for sensitive skin. The individually perforated wipes ensure easy extraction. The practical and solid storage container with lock-lid prevents the wipes from drying out.

Contents: 40 wipes, each 17 x 25 cm.

The must have for every cleaning job!



Effortlessly removes:

- Grease
- Paint
- Oil
- Tar
- Ink
- Silicone
- Glue
- and more...



Art. no.	wipes		kg	PU
150601	170 x 250		0,190	1

Freeze-Spray HUPcool

Application HUPcool:

HUPcool to remove dust, dirt and other deposits on computers, keyboards, engineering components, office equipment, photocopiers, printers, etc.
For cooling and debugging overheated parts.



Art. no.	ml		kg	PU
170400	400	Testing	0,455	1

Freeze-Spray HUPcoolXtra

Application HUPcoolXtra

For the detection of defects in electrical systems and electronics. With the freeze-spray thermal errors on electric, electronics, computer cases, cabinets, measuring and control technology instruments, optical equipment, hi-fi and video equipment, as well as modules, printed circuit boards, magnetic heads, thermal switches etc. are fast tracked.

Properties:

HUPcoolXtra is a freeze spray with that you achieve cooling to -50°C. Cooling of resistors and transistors to prevent heat damage during soldering.



Art. no.	ml		kg	PU
170402	400	Testing	0,455	1

Smoke-Detector-Test-Spray

HUPdetect

Application HUPdetect:

Test your smoke detectors once a month with this test spray, to exclude technical defect, as well as the contamination of the detector.

Properties:

- directly simulated fire smoke
- enough for about 150-200 test operations
- Fast and reliable



Art. no.	ml		kg	PU
170404	250	Testing	0,180	1

Our HUPchemie safety certificates can be found in the download section of www.haupa.com.

Soldering accessories



Soldering accessoires

Soldering irons

chrome nickel steel tube, with schuko safety plug, replaceable nickel-plated copper tips



Art. no.	TL	Volt	Watt	kg	PU
160142	265	220	60	0,322	1
160144	315	220	80	0,319	1
160146	320	220	100	0,324	1

Soldering irons

with plastic handle, with schuko safety plug, replaceable copper tips, nickel-plated



Art. no.	TL	Volt	Watt	kg	PU
160150	250	220	30	0,264	1

Soldering irons

soldering tip internally heated, chrome vanadium steel tube, with plastic handle, with schuko safety plug, replaceable nickel-plated copper tips, for electronic work



Art. no.	TL	Volt	Watt	kg	PU
160190	200	220	15	0,257	1

Torch brazing set SolderingKit

12-pieces, for pocket lighter butane gas, with Piezo ignition, heating time: +/- 25 seconds (peak), performance can be infinitely regulated, temperatures with naked flame up to 1200 °C, brazing up to 550 °C, heat shrinking up to 680 °C, burn time approximately 60 minutes, in black plastic case.



Art. no.	set	kg	PU
262098	12-pieces	0,387	1

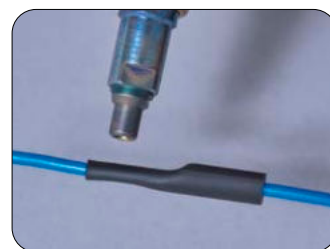

Soldering accessoires

Solder in triangular sticks DIN 1707

length approx. 430 mm, approx. 250 g per stick, size: 11 x 11 x 11 x 430 mm



Art. no.	Sn%	Roll/g	kg	PU
160112	30	250	0,275	1
160114	40	250	0,247	1

Soldering stone



Art. no.	kg	PU
160130	0,070	1

Soldering paste acc. to DIN 8511-F-SW 26

rosin halide-activated, field of application: electro-technic, electronics, manufacture of electrical appliances



Art. no.	kg	PU
160090	0,073	1

Soldering fluid acc. to DIN 8511-F-SW 32

rosin halide-activated, field of application: electro-technic, electronics, manufacture of electrical appliances



Art. no.	kg	PU
160092	0,054	1

Grease for soft-soldering acc. to DIN 8511-F-SW 21

ammonium chloride, organic preparation field of application: general soldering work



Art. no.	kg	PU
160094	0,072	1
160096	0,132	1

Soldering grease for fittings acc. to DIN 8511-F-W 22

field of application: sanitary technics, copper tubes etc.



Art. no.	kg	PU
160100	0,080	1

Soldering fluid acc. to DIN 8511-F-W 21

ammonium chloride, organic preparation field of application: sanitary technics, copper tubes etc.



Art. no.	kg	PU
160102	0,065	1

haupa®

...convincing solutions

HAUPA GmbH & Co. KG, Koenigstr. 165-169, 42853 Remscheid, Phone: +49 (0)2191 8418-0, Fax: +49 (0)2191 8418-840, sales@haupa.com

Solder for electronic work acc. to DIN EN 29453

antimony-free, soldering flux acc. To DIN EN 29454, 1.1.2.B (F-SW 26), S-Sn60Pb40, rosin halide-activated



Art. no.	Ø	Sn%	Roll/g	kg	PU	
160020	1	60	100	0,104	1	
160022	1	60	250	0,253	1	
160024	1	60	500	0,529	1	
160026	1	60	1000	1,008	1	
160028	1,5	60		1m	0,016	1
160030	1,5	60	100	0,106	1	
160042	1,5	60	250	0,247	1	
160044	1,5	60	500	0,528	1	
160046	1,5	60	1000	1,022	1	
160050	2	60	100	0,108	1	
160052	1	60	250	0,250	1	
160054	1	60	500	0,529	1	

Solder for electronic work acc. to DIN EN 29453

antimony-free, soldering flux acc. to DIN EN 29454, 1.1.2.B (F-SW 26), S-Sn60Pb40, rosin halide-activated



Art. no.	Ø	Sn%	Roll/g	kg	PU	
160000	1	60	100	1m	0,009	1
160002	1	60	100	0,106	1	
160004	1	60	250	0,259	1	
160006	1	60	500	0,528	1	
160008	1	60	1000	1,015	1	
160012	1,5	60	100	0,102	1	
160014	1,5	60	250	0,255	1	
160016	1,5	60	500	0,523	1	
160018	1,5	60	1000	1,024	1	

Solder for electronic work acc. to DIN EN 29453

antimony-free, soldering flux acc. To DIN EN 29454, 1.1.2.B (F-SW 26), S-Pb60Sn40, rosin halide-activated



Art. no.	Ø	Sn%	Roll/g	kg	PU
160060	2	40	100	0,106	1
160062	2	40	250	0,257	1

Fittings' solder acc. to DIN EN 29453

low antimony content, soldering flux acc. to DIN EN 29454, 2.1.3.B (F-SW 24), S-Pb60Sn40, ammonium chloride based, organically prepared



Art. no.	Ø	Sn%	Roll/g	kg	PU	
160070	1,5	40		1m	0,018	1
160072	2	40	100	0,103	1	
160074	2	40	250	0,258	1	

Solder wire according to DIN EN 29453

lead-free special alloy, 2.5% flux percentage according to DIN EN 29454, 1.1.2.B (EN-61190-ROLO), 1.00 mm of Ø, 0,100 kg spools S-Sn99Cu1, DIN EN 29453 (Sn99, 3Cu0,7 - eutectic)



Art. no.	Ø	Sn%	Roll/g	kg	PU
160420	1	99	100	0,114	1
160422	1	99	250	0,262	1
160424	1	99	500	0,536	1
160426	1	99	1000	1,000	1
160430	1,5	99	100	0,112	1
160442	1,5	99	250	0,266	1
160444	1,5	99	500	0,500	1
160446	1,5	99	1000	1,000	1
160450	2	99	100	0,109	1
160452	2	99	250	0,257	1
160454	2	99	500	0,527	1

Solder wire according to Din EN 29453

lead-free special alloy, 3.5% flux percentage according to DIN EN 29454, 1.1.3.B (EN-61190-ROLO), 1.00 mm of Ø, 0, 100 kg spools S-Sn99Cu1, DIN EN 29453 (Sn99, 3Cu0,7 - eutectic)



Art. no.	Ø	Sn%	Roll/g	kg	PU
160402	1	99	100	0,114	1
160404	1	99	250	0,250	1
160406	1	99	500	0,500	1
160408	1	99	1000	1,000	1
160414	1,5	99	250	0,258	1
160416	1,5	99	500	0,535	1
160418	1,5	99	1000	1,000	1

BRINKO[®]

powered by **haupa**[®]



Pliers



Pipe Pliers

618 Pipe pliers 45°

- Chrome vanadium steel, forged
- finger pinch protection



Art. no.	↔	∅ mm	∅ "	kg	PU
618/1	310	0 - 49	1	0,725	1
618/11/2	425	0 - 65	1 1/2	1,572	1
618/2	540	0 - 84	2	2,648	1
618/3	685	0 - 120	3	4,100	1
618/4	815	0 - 135	4	5,650	1

619 Corner pipe pliers

- Chrome vanadium steel, forged
- special hardened teeth
- S-opening, polished
- finger pinch protection



Art. no.	↔	∅ mm	∅ "	kg	PU
619/1/2	245	0 - 39	1/2	0,443	1
619/1 *	320	0 - 49	1	0,821	1
619/11/2 *	440	0 - 68	1 1/2	1,416	1
619/2	560	0 - 85	2	2,380	1
619/3	675	0 - 120	3	2,700	1

9001 Pipe pliers set

Consisting of:

1 corner pipe pliers 1" Art. no. 619/1

1 corner pipe pliers 1 1/2" Art. no. 619/11/2

1 water pump pliers 240 mm Art. no. 685/240

- corner pipe pliers with S-opening and finger pinch protection
- special hardened teeth



Art. no.	set	kg	PU
9001	3	2,581	1

Water Pump Pliers

685 Water pump pliers

- Chrome vanadium steel
- heavy duty, high quality finish
- Jaw grips inductively hardened
- with through joint
- Finger pinch protection
- polished jaws and joint
- handle with black hammerseige and yellow color



Art. no.	↔	∅ mm	∅ mm	∅ "	kg	PU
685/175	175	32	33	1 2/7	0,152	5
685/240	240	39	40	1 4/7	0,308	5
685/300	300	52	53	2	0,528	5

687 Water pump pliers

- Chrome vanadium steel, chrome-plated
- Jaw grips inductively hardened
- special hardened teeth for extra long life
- inox push button & spin
- self locking on pipes and nuts
- with finger pinch protection
- with press-button single hand adjustment
- nose brightly polished
- soft dip insulated anti-slip handles, yellow
- with push-button single hand adjustor
- 11-fold precision adjustment



Art. no.	↔	∅ mm	∅ mm	∅ "	kg	PU
687/150	150	30	32	1 1/4	0,135	1
687/180 *	180	36	40	1 1/2	0,191	5
687/250 *	250	46	50	2	0,326	5
687/300 *	300	60	70	2 3/4	0,550	1

Instrument Keys

682/250 Water pump pliers | automatic

- Chrome vanadium steel
- nose brightly polished
- soft dip insulated anti-slip handles, yellow
- automatic jaw width adjustment by simply slipping handles together, without snap adjustment
- with finger pinch protection
- patented technology



Art. no.	↔ mm	⊘ mm	⊘ mm	⊘ "	kg	PU
682/250	250	42	46	1 1/2	0,361	1

689 Fittings pliers | Key pliers

- Chrome vanadium steel, matt chrome-plated
- automatic jaw width adjustment, with push-button single hand adjuster
- with finger pinch protection, a parallel gripping and a moving jaw
- smooth, polished gripping surfaces
- soft dip insulated anti-slip handles, yellow
- weight-reduced
- 10 times hand force
- replaces open-end wrench set



Art. no.	↔ mm	⊘ mm	⊘ "	kg	PU
689/180	180	36	1 7/16	0,350	1
689/240	240	50	2	0,375	5

21/250 Quick release wrench

- Chrome vanadium steel
- length 250 mm
- span width 65 mm



Art. no.	↔ mm	⊘ mm	kg	PU
21/250 *	250	65	0,735	1

22-1/300 Instrument key

- Chrome vanadium steel
- inner roller
- protective jaws made of brass
- length 300 mm
- span width 80 mm



Art. no.	↔ mm	⊘ mm	kg	PU
22-1/300	300	80	0,867	1

27/300 Instrument key

- Chrome vanadium steel
- inner roller
- protective jaws made of plastic
- length 300 mm
- span width 80 mm



Art. no.	↔ mm	⊘ mm	kg	PU
27/300	300	80	0,832	1

More Pliers

1608/60 Folding pliers

- forged steel
- straight shape
- length 260 mm
- jaw width 60 mm



Art. no.	Length	Width	kg	PU
1608/60	260	60	0,575	1

1609/60 Folding pliers

- forged steel
- 45° angled shape
- length 260 mm
- jaw width 60 mm



Art. no.	Length	Width	kg	PU
1609/60	260	60	0,600	1

1609-1/60 Folding pliers

- forged steel
- 90° angled shape
- length 260 mm
- jaw width 60 mm



Art. no.	Length	Width	kg	PU
1609-1/60	260	60	0,602	1

1616/620 Gutter brackets bending pliers

- with feed roller
- also suitable for plastic-coated gutter brackets
- length 620 mm
- bends up to 40 x 6 mm



Art. no.	Length	kg	PU
1616/620	620	3,200	1

663 Siphon pliers

- chrome-plated, plastic covered handles
- 4 adjustment options
- length 240 mm
- span width 80 mm



Art. no.	Length	Span width	kg	PU
663	240	80	0,280	1

516/220 Revolving punch pliers

- special sheet steel
- with 6 pipes: Ø 2.0, 2.5, 3.0, 3.5, 4.0, 4.5 mm
- length 220 mm



Art. no.	Length	Ø mm	kg	PU
516/220	220	2,0 - 4,5	0,336	1

522 Blind riveting pliers

- for rivets Ø 2.4 - 5.0 mm
- length 200 mm



Art. no.	Length	Ø mm	kg	PU
522	200	2,4 - 5	0,625	1

543/120 Schaffner control pliers

- polished, nickel-plated
- 3 mm round mandrel
- jaw depth of perforation Ø 30 mm



Art. no.	Ø mm	kg	PU
543/120	30	0,173	1

546 Sealing pliers

- polished, nickel-plated
- handles plastic-coated, red
- with a stamp



Art. no.	TL mm	Ø mm	kg	PU
546/130	130	8	0,246	1
546/150	150	9	0,330	1
546/170	170	10	0,484	1

Sealing Tools

546-1 Sealing stamp

- suitable for sealing pliers Art. no. 546
- signatures according to customer request



Art. no.	Ø mm	kg	PU
546-1/8	8	0,003	1
546-1/9	9	0,003	1
546-1/10	10	0,003	1

546-10 Sealing stamp

- suitable for sealing stamp Art. no. 546-1



Art. no.	number of digits	PU
546-10	1	1
546-20	2	1
546-30	3	1
546-40	4	1
546-50	5	1
546-60	6	1

548 Lead seal

- packaged at 1 kg each



Art. no.	Ø mm	kg	PU
548/8	8 mm	1,005	1
548/9	9 mm	1,012	1
548/10	10 mm	1,016	1
548/12	12 mm	1,018	1

550/180 Seal wire

- length 180 mm
- grouped together 1000 units



Art. no.	TL	kg	PU
550/180	180	0,484	1

551/500 Seal wire

- on plastic roller
- 500 gr
- wire thickness 0.5 x 0.3 mm
- length approx. 115 m



Art. no.	TL m	kg	PU
551/500	115	0,578	1

BRINKO[®]
powered by haupa

More Pipe Pliers

696/240 Lead pipe sizing pliers

- made of sheet steel
- length 240 mm
- pipes \varnothing 1 1/2"
- for tubes up to 54 mm



Art. no.	↔ mm	∅ mm	kg	PU
696/240	240	40	0,434	1

623/3/4-4 Chain pipe wrench

- Chrome vanadium steel, bright nickel-plated
- length 320 mm
- pipes 3/4 - 4"
- replacement chain Art. no. 623-1



Art. no.	↔ mm	∅ mm	∅ "	kg	PU
623/3/4-4	320	30 - 200	3/4 - 4	0,940	1

623-1/3/4-4 Replacement chain

- suitable for chain pipe wrench Art. no. 623



Art. no.	↔ mm	∅ mm	∅ "	kg	PU
623-1/3/4-4	320	30 - 200	3/4 - 4	0,359	1

660 Strap wrench

- fits on all round or angular shapes
- clamping range \varnothing 170 mm
- strap width 20 mm
- solves space problems, easy to use
- suitable for many commercial purposes



Art. no.	∅ mm	kg	PU
660	20	0,233	1



Wrenches, Keys and Inserts



Open-End & Point Ring Wrenches

83 Ratchet wrenches 4 in 1

4 in 1

The ratchet wrench handles 4 different nut sizes

- Sizes: 10 x 13 mm and 17 x 19 mm
- finely toothed 72 teeth of the 2 ratchets - ratchets can be switched to clockwise/counterclockwise operation
- due to 12-slided toothing, the wrench easily grips 4, 6 and 12-sided screws as well as almost round nuts
- Chrome-vanadium steel, chrome-plated
- extremely robust



Art. no.	span width	span width	kg	PU
83 *	200	10 x 13 17 x 19	0,283	5

56 Open-end wrench

- Chrome vanadium steel, chrome-plated
- long, slimline shape
- very high strength
- tight tolerances



Art. no.	span width	span width	kg	PU
56/8x9	8	9	0,096	3
56/10x11	10	11	0,133	3
56/10x13 *	10	13	0,049	3
56/12x13	12	13	0,061	3
56/14x15	14	15	0,082	3
56/14x17	14	17	0,110	3
56/16x17	16	17	0,114	3
56/17x19 *	17	19	0,180	3
56/18x19	18	19	0,151	3
56/20x22	20	22	0,203	3
56/21x23	21	23	0,230	3
56/22x24	22	24	0,248	3
56/24x27 *	24	27	0,302	3
56/25x28	25	28	0,400	3
56/30x32	30	32	0,498	3
56/36x41	36	41	1,014	3
56/41x46	41	46	1,625	3
56/46x50	46	50	1,570	3

64 Combination wrench

- Chrome vanadium steel, chrome-plated
- long, slimline shape
- very high strength
- tight tolerances
- ring end at 15° angle



Art. no.	span width	kg	PU
64/10 *	10	0,043	3
64/13 *	13	0,079	3
64/17 *	17	0,163	3
64/19	19	0,208	3
64/24	24	0,350	3

58-1 Open-end wrench set

- Chrome vanadium steel, chrome-plated
- long, slimline shape
- very high strength
- tight tolerances



Art. no.	set	span width	kg	PU
58-1/8	8	6 - 22	0,797	1
58-1/10 *	10	6 - 27	1,363	1
58-1/12	12	6 - 32	2,300	1

66-1 Combination wrench set

- Chrome vanadium steel, chrome-plated
- long, slimline shape
- very high strength
- tight tolerances
- ring end at 15° angle



Art. no.	set	span width	kg	PU
66-1/8	7	6 - 19	0,890	1
66-1/10 *	10	8 - 22	1,112	1

81-1/10 Twelve-point ring wrench set

- Chrome vanadium steel, chrome-plated
- width across flats 6 x 7 - 24 x 27 mm
- long, slimline shape
- very high strength
- tight tolerances
- at 75° angle



Art. no.	set	span width	kg	PU
81-1/10	10	6 - 27	2,196	1

49 Adjustable wrench

- special steel, chrome-plated
- head polished chrome-plated
- opening 22° angled
- adjustable



Art. no.	span width	degrees °	kg	PU
49/250	250	30	0,421	1
49/310	310	36	0,657	1

Plumbing Wrenches

105/10 Plumbing installation wrench

- for attaching washbasins and angle valves
- forged chrome vanadium steel, promat galvanised
- length 215 mm
- key width 17 x 19 mm
- holding thread M10



Art. no.	span width	kg	PU
105/10 *	215	0,242	5

106 Plumbing four-way socket wrench

- DPMA (utility model protection) for sanitary installations
- chrome vanadium steel, bright chrome-plated
- for valve extensions up to 100 mm: 3/8", 1/2", 3/4", 1"
- internal thread for hanger bolts: M8, M10 (with counter thread), M12
- hexagon: size 10, 12 and size 17, 22 with double groove
- square socket for pipe plugs: 3/8" and 1/2"

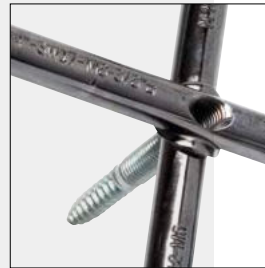

Art. no.	span width	kg	PU
106	10 - 22	0,570	2

106-2 Plumbing four-way socket wrench

- especially for sanitary installations
- chrome vanadium steel, bright chrome-plated
- for valve extensions up to 80 mm, 3/8", 1/2", 3/4", 1"
- internal thread for hanger bolts M8, M10, M12
- hexagon for pipe plugs size 10, 12, 17, 22 mm



Art. no.	span width	kg	PU
106-2	10 - 22	0,540	2

Socket Wrenches & Inserts

101/10 Hanger bolt nut

- Hanger bolt nut \varnothing 10 mm
- universal attachment for all 1/2" ratchet and hexagonal SW 22 mm
- right and left turn
- for fast and effortless screwing and unscrewing of stay bolts, express and hanger bolts without damaging the thread
- with inside square



Art. no.	kg	PU
101/10	0,188	6

102 Hanger bolt driver

Multidirectional hanger bolt driver

- Screw-in and screw-out tool hanger bolt driver \varnothing 8 mm and \varnothing 10 mm
- self-clamping when turned
- for fast and effortless screwing and unscrewing of stay bolts, express and hanger bolts without damaging the thread
- with hexagonal driver for power tools



Art. no.	\varnothing	kg	PU
102/8 *	8	0,084	6
102/10 *	10	0,114	6

103 Hanger bolt wrench

- DBGM, bright chrome-plated
- with adjustable chuck for M6, M8, M10, M12 thread
- with 1/2" square to drive and unlock



Art. no.	kg	PU
103	0,288	1

1088 Sleeve extractor set

For the extraction of threaded pipe connections, sleeves and nipples

The extractors are struck into the thread and the pipe or threaded connection is undone

- the extractor service life varies depending on the hardness of the counter material
- the tools are intended for single use when dealing with a mating material that displays a certain level of hardness
- Material: CrV-steel, hardened
- Surface: Bronzed, polished cutting surface

Supplied in a stable case, 5-piece set

- 1 sleeve extractor 3/8"
- 1 sleeve extractor 1/2" - 3/4"
- 1 hexagonal insert 1/2", size 26
- 1 hexagonal insert 1/2", size 19
- 1 reversible ratchet, inner and outer square drive bit, 1/2" drive



Art. no.	set	kg	PU
1088 *	5	1,426	1

1087 Sleeve extractor

For the extraction of threaded pipe connections, sleeves and nipples

The extractors are struck into the thread and the pipe or threaded connection is undone

- the extractor service life varies depending on the hardness of the counter material
- the tools are intended for single use when dealing with a mating material that displays a certain level of hardness
- Material: CrV-steel, hardened
- Surface: Bronzed, polished cutting surface



Art. no.	"	kg	PU
1087/5	3/8	0,096	1
1087/7	1/2" - 3/4	0,262	1

Socket Wrenches & Inserts

127-1 Socket wrench set "BRImultiLock" | 87 pieces

1/2" 1/4"

Troubleshooter!

BRINKO „BRImultiLock“ for damaged, contorted Hex-Bolts

- Reversible ratchet with inner and outer hexagon
- twelve-tooth profile, 1/2" and 1/4" drive

Material: Cr-V 50BV30 steel | Industrial quality | Standards: DIN 3124; ISO 2725 | Finishing: Silver mat finished | Profile: BRImultiLock - Best solution for variety bolts | Torsion: 30-50% (depends on size) higher than DIN | Life-Time: 200k circle times at 35% of DIN | square drive

Content:

- Plumber Ratchets 1/4", 1/2"
- Universal joint 1/4", 1/2"
- Spinner Handle incl. adapter 1/4", 150 mm
- Sliding T Bar 1/4", 150 mm
- Extension Bar 1/4", 50 - 100 mm
- Extension Bar 1/2", 125 - 250 mm
- Plug Sockets 1/2", 16 - 21 mm
- Bit Adapter 1/2" - 5/16"
- BRImultiLock Socket 1/2" SW 10 - 12 - 13 - 15 - 16 - 17 - 18 - 19 - 20 - 21 - 22 - 24 - 27 - 30 - 32 mm
- Deep Socket 1/2" SW 14 - 15 - 17 - 19 mm
- BRImultiLock Socket 1/4" SW 4 - 4.5 - 5 - 5.5 - 6 - 7 - 8 - 9 - 10 - 11 - 12 - 13 - 14 mm
- Deep Socket 1/4" SW 6 - 7 - 8 - 9 - 10 - 11 - 12 - 13 mm
- Bits, slot 1/4" 4 - 5.5 - 6.5 mm
- Bits, cross slot 1/4" PH 1, 2 | PZ 1, 2
- Bits, allen key 1/4" 3 - 4 - 5 - 6 mm
- Bits, Tx 1/4" Tx 8 - 10 - 15 - 20 - 25 - 30
- Bits, cross slot 1/4" PH 1, 2 | PZ 1, 2
- Bits, allen key 1/4" 3 - 4 - 5 - 6 mm
- Bits, Tx 1/4" Tx 8 - 10 - 15 - 20 - 25 - 30
- Bit Adapter 1/4 - 5/16"
- Bits, slot 5/16" 8 - 10 - 12 mm
- Bits, cross slot 5/16" PH 3, 4 | PZ 3, 4
- Bits, allen key 5/16" 8 - 10 - 12 - 14 mm
- Bits, Tx 5/16" Tx 40 - 45 - 50 - 55



Troubleshooter!
BRINKO „BRImultiLock“
for damaged, contorted
Hex-Bolts



Art. no.	set	kg	PU
127-1	87	5,931	1

122 Socket wrench set "BRImultiLock" | 55 pieces

1/4"

Troubleshooter!

BRINKO „BRImultiLock“ for damaged, contorted Hex-Bolts

- Reversible ratchet with inner and outer hexagon
- twelve-tooth profile, 1/4" drive

Material: Cr-V 50BV30 steel | Industrial quality | Standards: DIN 3124; ISO 2725 | Finishing: Silver mat finished | Profile: BRImultiLock - Best solution for variety bolts | Torsion: 30-50% (depends on size) higher than DIN | Life-Time: 200k circle times at 35% of DIN | square drive

Content:

- Plumber Ratchets 1/4"
- Universal joint 1/4"
- Sliding T Bar 1/4"
- Spinner Handle incl. adapter 1/4", 150 mm
- Hex keys 1,5 - 2,0 - 2,5
- Extension Bar 1/4", 50 - 100 mm
- BRImultiLock Socket 1/4" SW 4 - 4.5 - 5 - 5.5 - 6 - 7 - 8 - 9 - 10 - 11 - 12 - 13 - 14 mm
- Deep Socket 1/4" SW 6 - 7 - 8 - 9 - 10 - 11 - 12 - 13 mm
- Socket Tx-E 1/4" E 4 - 5 - 6 - 7 - 8
- Bits, cross slot 1/4" PH 1, 2, 3 | PZ 1, 2, 3
- Bits, slot 1/4" 4 - 5.5 - 7 mm
- Bits, allen key 1/4" 3 - 4 - 5 - 6 - 7 mm
- Bits, Tx 1/4" Tx 8 - 10 - 15 - 20 - 25 - 27 - 30 - 40



Troubleshooter!
BRINKO „BRImultiLock“
for damaged, contorted
Hex-Bolts



Art. no.	set	kg	PU
122	55	1,836	1

BRINKO[®]
powered by **haupa**

Socket Wrenches & Inserts

129-3/250 Reversible ratchet 1/2"

1/2"

- 1/2" drive with square socket and square drive bit
- length 250 mm

Material: Cr-V; Cr-Moly steel | Industrial quality | Standards: DIN 3122; ISO 3315 | Finishing: Silver mat finished | Torsion: 30% higher than DIN | LifeTime: 20k circle times



Art. no.	span width	kg	PU
129-3/250	250	0,520	1

123-1/110 Reversible ratchet 1/4"

1/4"

- 1/4" drive connecting square
- length 110 mm

Material: Cr-V; Cr-Moly steel | Industrial quality | Standards: DIN 3122; ISO 3315 | Finishing: Silver mat finished | Torsion: 30% higher than DIN | LifeTime: 20k circle times



Art. no.	span width	kg	PU
123-1/110	110	0,140	1

128 Universal screw insert

1/2"

- Chrome vanadium steel, chrome-plated
- 1/2" drive, size 22 mm
- the steel pins automatically adjust to every shape from Ø 9 – 21 mm
- also suitable for rounded or damaged shapes
- Caution: not suitable for impact wrenches!



Art. no.	span width	kg	PU
128	22	0,138	1

129-12 "BRImultiLock" insert

1/2"

- hexagon, 1/2" drive
- also for loosening rounded and damaged Hex-Bolts

Material: Cr-V 50BV30 steel | Industrial quality | Standards: DIN 3124; ISO 2725 | Finishing: Silver mat finished | Profile: BRImultiLock - Best solution for variety bolts | Torsion: 30-50% (depends on size) higher than DIN | Life-Time: 200k circle times at 35% of DIN | square drive



Art. no.	span width	kg	PU
129-12/10	10	0,046	3
129-12/11	11	0,058	3
129-12/13	13	0,050	3
129-12/14	14	0,063	3
129-12/17	17	0,061	3
129-12/19	19	0,065	3
129-12/22	22	0,085	3
129-12/24	24	0,104	3
129-12/26	26	0,116	3
129-12/29	29	0,167	3
129-12/32	32	0,215	3

672/265 Reversible ratchet

1/2"

- Chrome vanadium steel, chrome-plated
- with 1/2" square drive
- length 265 mm
- WITHOUT connecting square



Art. no.	span width	kg	PU
672/265	265	0,459	1

674 Step wrench set

1/2"

- 1 reversible ratchet Art. no. 672/265
- 1 step wrench, 105 mm Art. no. 673/105
- supplied in DIY pouch



Art. no.	span width	kg	PU
674 *	105	0,679	1

Socket Wrenches & Inserts

675 Step wrench set

1/2"

- 1 resetting ratchet Art. no. 672/265
- 1 step wrench, 86 mm Art. no. 673/86
- supplied in DIY pouch



Art. no.	span width	kg	PU
675 *	86	0,556	1

129-30 Torque wrench

1/4"

- automatic with advance setting
- reversible ratchet with 1/4" drive
- 3 inserts: 6, 8, 10 mm
- the main scale (engraving) is on the wrench
- the values increase in steps of 2 Nm each from 6 - 30 Nm
- the ring scale for fine settings is located on the rotating handle
- the lines for the in-between values each correspond to 0.2 Nm



Art. no.	span width	Nm	kg	PU
129-30	300	6 - 30	0,935	1

123-7 Hexagonal insert

1/4"

- hexagonal inserts
- 1/4" drive



Art. no.	span width	kg	PU
123-7/6	6	0,011	1
123-7/8	8	0,012	1
123-7/10	10	0,014	1
123-7/13	13	0,024	1

129-13/13 Hexagonal insert XL

1/2"

- Chrome vanadium steel, chrome-plated
- 1/2" drive
- key width 13 mm
- total length 75 mm
- extra long design for problem-free assembly of inside wall installation rails



Art. no.	span width	kg	PU
129-13/13	75	0,110	3

129-14/6 Allen insert

1/2"

- Chrome vanadium steel, chrome-plated
- allen key 6 mm
- 1/2" drive



Art. no.	span width	kg	PU
129-14/6	6	0,065	3

129-100 Adaptor

3/4" 1/2"

- Chrome vanadium steel, chrome-plated
- square socket 3/4"
- square bit drive 1/2"



Art. no.	kg	PU
129-100	0,171	1

127-2 Extension | bendy

1/4"

- 1/4" drive
- length 150 mm



Art. no.	span width	kg	PU
127-2	150	0,068	1

BRINKKO
powered by haupa®

Socket Wrenches & Inserts

129-7/125 Extension

1/2"

- Chrome vanadium steel, chrome-plated
- 1/2" drive
- length 125 mm



Art. no.	span width	kg	PU
129-7/125	125	0,192	1

129-9/1/2 Connecting square

1/2"

- Chrome vanadium steel, chrome-plated
- 1/2"
- for reversible ratchets



Art. no.	kg	PU
129-9/1/2	0,044	2

92 Socket wrench

1/2"

- precision steel pipe (DIN 896B), drawn seamlessly, chrome-plated
- Other sizes available on request.



Art. no.	span width	span width	kg	PU
92/6x7	6	7	0,026	6
92/8x9	8	9	0,042	6
92/10x11	10	11	0,052	6
92/12x13	12	13	0,071	6
92/14x15	14	15	0,090	6
92/17x19	17	19	0,155	6
92/19x22	19	22	0,248	6
92/20x22	20	22	0,248	6
92/22x24	22	24	0,276	3
92/24x27	24	27	0,296	3
92/30x32	30	32	0,416	2
92/32x36	32	36	0,539	2

92-1 Socket wrench set

1/2"

- 6 pieces: 10 x 11, 12 x 13, 14 x 15, 17 x 19, 19 x 22, 24 x 27 mm
- seamlessly drawn precision steel pipe (DIN 896 B) chrome-plated



Art. no.	set	kg	PU
92-1	6	1,140	1

94 Socket wrench

1/2"

- Precision hexagonal steel pipe, chrome-plated
- Other sizes available on request.



Art. no.	span width	kg	PU
94/10	10	0,080	6
94/13	13	0,860	6
94/17	17	0,809	6
94/19	19	0,914	6
94/22	22	1,190	6
94/36	36	1,366	3

90 Hexagon socket wrench

1/2"

- for installing mixers and taps on washbasins, as well as for door opening at elevators
- with movable T-handle, promat galvanised



Art. no.	span width	kg	PU
90/9	9	0,224	6
90/10	10	0,224	6
90/11	11	0,250	6
90/12	12	0,250	6
90/13	13	0,250	6

Socket Wrenches & Inserts

104 Triangular socket wrench



- for explosion-endangered lighting systems, junction boxes as well as for door opening at elevators
- precision steel pipe, brightnickel-plated (DIN 22417)
- with movable T-handle



Art. no.	span width	kg	PU
104/3	90	0,025	6
104/4	90	0,028	6
104/5	100	0,030	6
104/6	112	0,060	6
104/8	125	0,083	6
104/10	140	0,159	6

Step Wrenches

670/170 Step wrench for radiator

- Chrome vanadium steel, forged
- for radiator screw connections
- with square bit drive 18 mm
- length 170 mm
- 5 steps for valve nipples 3/8" - 1/2" - 3/4" - 1" - 1 1/4"



Art. no.	kg	PU
670/170	0,237	5

671/240 Turning tool

- square drive 18 mm
- length 240 mm
- suitable for step wrenches with square drive 18 mm



Art. no.	kg	PU
671/240	0,280	1

673/86 Step wrench for radiator and water

1/2"

- Chrome vanadium steel, chrome-plated, with slot
- for radiator screw connections and short valve extensions
- with 1/2" square drive
- 6 steps 9.5, 9.8, 11.8, 12.8, 13.8, 17.0



Art. no.	span width	kg	PU
673/86 *	9,5 - 17	0,097	2

673/105 Step wrench for radiator and water

1/2"

- Chrome vanadium steel, chrome-plated, with slot
- for radiator screw connections and short valve extensions
- with 1/2" square drive
- 9 steps 8.0, 9.5, 9.8, 11.8, 12.8, 13.8, 16,8 21.5, 22.0



Art. no.	span width	kg	PU
673/105 *	8 - 22	0,136	2

673-1/1 Step wrench for gas

- chrome-plated, with groove
- for gas tap connection fittings
- 4 steps 12.0, 13.0, 14.0, 15.0



Art. no.	span width	kg	PU
673-1/1	12 - 15	0,138	2

673-1/2 Step wrench for gas

- chrome-plated, with groove
- for gas tap connection fittings
- 3 steps 19.0, 22.0, 24.0



Art. no.	span width	kg	PU
673-1/2	19 - 24	0,175	2

BRINKKO
powered by haupa®

Step Wrenches

673-2/2 Step wrench for gas and water

- chrome-plated, with groove
- combined use for tap extensions and gas tap connection fittings
- 5 steps 15.0, 17.0, 19.0, 22.0, 24.0

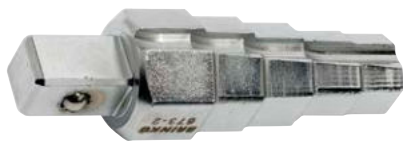

Art. no.	span width	kg	PU
673-2/2	86	15 - 24	0,181 2

666/1 Step wrench

- with movable T-handle
- small design for valve nipples
- 2 steps for valve nipples 3/8", 1/2" with slot



Art. no.	span width	kg	PU
666/1	9,5 - 17	0,106	3

666/2 Step wrench

- with movable T-handle
- small design for valve nipples
- 3 steps for valve nipples 3/8", 1/2", 3/4"



Art. no.	span width	kg	PU
666/2	10 - 17	0,195	3

Hex Keys

110 Hex key set



- 9 pieces: Tx 10, 15, 20, 25, 27, 30, 40, 45, 50
- chrome vanadium steel, bright nickel-plated
- long design, even easy to reach greatly recessed screws
- unfolding plastic holder allows free access



Art. no.	set	Tx	kg	PU
110	9	10 - 50	0,418	5

111/2 Hex key set



- 7 pieces: 2.5, 3, 4, 5, 6, 8, 10 mm
- chrome vanadium steel, polished nickel-plated
- the ball-end allows you to screw up to a 30° angle
- in a practical, strong fold-out holder with lifting button



Art. no.	set	size	kg	PU
111/2	7	2.5 - 10	0,364	5

114 Hex key set



- 9 pieces: 1.5, 2, 2.5, 3, 4, 5, 6, 8, 10 mm
- Chrome vanadium steel, bright nickel-plated
- long design
- hex/ball-end combined
- the ball-end allows you to screw up to a 30° angle
- unfolding plastic holder allows free access
- with belt clip



Art. no.	set	size	kg	PU
114	9	1.5 - 10	0,422	5

Hex Keys

115/2 Hex key set



- 9 pieces: 1.5, 2, 2.5, 3, 4, 5, 6, 8, 10 mm
- Chrome vanadium steel, bright nickel-plated
- hex head/ball-end combined
- the ball-end allows you to drive a screw at up to a 30° angle
- in a strong plastic holder
- practical removable handle to work comfortably - as T- or angled handle or screwdriver



T-HANDLE



SCREWDRIVER-HANDLE



ANGLED HANDLE

Art. no.	set	size	kg	PU
115/2	9	1.5 - 10	0,513	5

112 Hex key



- Chrome vanadium steel, bright nickel-plated



Art. no.	span width	kg	PU
112/1,5	1,5	0,090	12
112/2	2	0,100	12
112/2,5	2,5	0,003	12
112/3	3	0,005	12
112/4	4	0,010	12
112/5	5	0,016	12
112/6	6	0,028	12
112/7	7	0,035	12
112/8	8	0,050	12
112/9	9	0,075	12
112/10	10	0,120	12
112/11	11	0,130	12
112/12	12	0,150	12
112/13	13	0,203	12
112/14	14	0,283	12
112/15	15	0,307	12
112/17	17	0,466	12
112/19	19	0,660	6
112/22	22	0,950	6
112/24	24	1,200	6

109 Tap extension wrench

- Chrome vanadium steel, bright-nickel-plated
- socket wrench for tap extensions and pipe plugs



Art. no.	size	kg	PU
109/1	3/8 x 3/4" 3/8"	0,219	2
109/2	1/2 x 3/4" 3/8"	0,252	2

Screwing Tools



Screwing Tools

2122 Screwdriver set



- 6 pieces:
- 4 slot-head screwdrivers 80 x 3, 100 x 4, 125 x 5.5, 150 x 6.5 mm
- 2 Pozidriv screwdrivers PZ 1, PZ 2
- chrome vanadium steel
- matt chrome-plated blades
- 2-component handle with a hole



Roll repressive

Art. no.	set	kg	PU
2122 *	6	0,430	1

2070 Workshop screwdriver



- Chrome vanadium steel
- matt chrome-plated blade
- 2-component handle with a hole

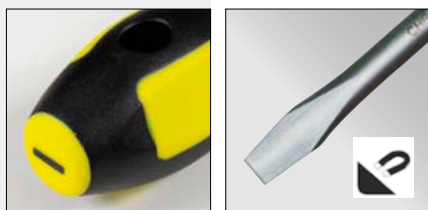

Art. no.	BL	BL	kg	PU
2070/125	125	6	0,087	6
2070/150	150	8	0,120	6

2066 Screwdriver



- Chrome vanadium steel
- matt chrome-plated blade
- 2-component handle with a hole

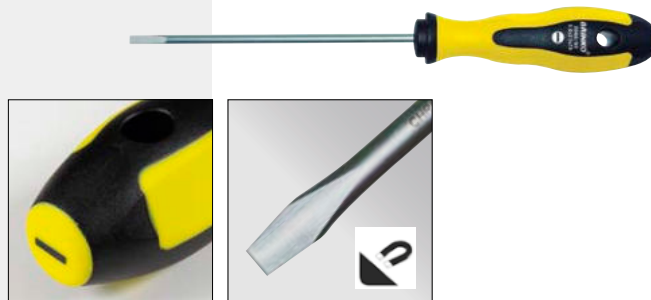

Art. no.	BL	BL	kg	PU
2066/80	80	3	0,022	6
2066/100	100	3,5	0,026	6

2080 Screwdriver | PZ



- Chrome vanadium steel
- matt chrome-plated blade
- 2-component handle with a hole



Art. no.	BL	PZ	kg	PU
2080/1	80	1	0,049	6
2080/2	100	2	0,081	6

2080-1 Screwdriver | PH



- Chrome vanadium steel
- matt chrome-plated blade
- 2-component handle with a hole



Art. no.	BL	PH	kg	PU
2080-1/1	80	1	0,048	6
2080-1/2	100	2	0,076	6

Screwing Tools

2126/7 Screwdriver set 1000 V



- 7 pieces, 1000 V:
4 slot-head screwdrivers 1000 V
75 x 2.5, 100 x 4, 125 x 5.5, 150 x 6.5 mm
2 cross-head screwdrivers 1000 V PZ 1, PZ 2
- 1 safety voltage tester 150 - 250 Volt (GS-certified)
- chrome vanadium steel
- matt chrome-plated blades with protective insulation
- 2-component hand with a hole
- individually tested to IEC 60900

⚠ 1000 V IEC 60900



Roll repressive

Art. no.	set	kg	PU
2126/7 *	7	0,514	1

2073-8 Screwdriver 1000 V



- 1000 V, chrome vanadium steel
- matt chrome-plated blade with protective insulation
- 2-component handle with a hole
- individually tested to IEC 60900

⚠ 1000 V IEC 60900

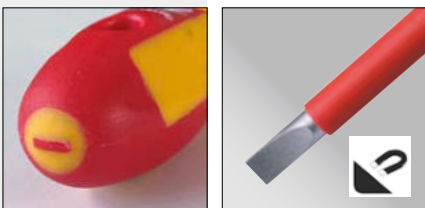

Art. no.	BL	BL	kg	PU
2073-8/75	75	2,5	0,035	6
2073-8/100	100	4	0,056	6
2073-8/125	125	5,5	0,088	6
2073-8/150	150	6,5	0,110	6

2079-18 Screwdriver 1000 V | PZ



- for work in the vicinity of live parts up to 1000
- chrome-vanadium-steel, 2-component hand with a hole
- matt chrome plated blade with protective insulation
- individually tested to IEC 60900

⚠ 1000 V IEC 60900



Art. no.	BL	PZ	kg	PU
2079-18/1	80	1	0,060	6
2079-18/2	100	2	0,090	6

2079-8 Screwdriver 1000 V | PH



- for work in the vicinity of live parts up to 1000
- chrome-vanadium-steel, 2-component hand with a hole
- matt chrome plated blade with protective insulation
- individually tested to IEC 60900

⚠ 1000 V IEC 60900



Art. no.	BL	PH	kg	PU
2079-8/1	80	1	0,059	6
2079-8/2	100	2	0,090	6

2088/145 Safety voltage tester



- blade Chrome vanadium steel
- for 150 - 250 V AC, with clip
- total length 145 mm, GS certified
- slot width 4 mm



Art. no.	BL	kg	PU
2088/145	145	4	0,016 12

BRINKKO
powered by haupa®

2088-1/145 Voltage tester set



- blade Chrome vanadium steel
- for 150 – 250 V AC, with clip
- set 145 mm long GS-tested
- slot width 4 mm, 12 units in a plastic tear-off bag



Art. no.	Length	BL	kg	PU
2088-1/145	145	4	0,018	12

2128 Screwdriver set with striking cap



- 2 K impact screwdrivers
- Slot-head and cross-head PH with hexagonal shaft and striking cap
- for attachment point with continuous blade and strike plate
- made of CV steel for direct impact transfer from plate to tip
- Sizes:
slot-head 1 x 3.5 | 1 x 4.5 | 1 x 5.5 | 1 x 6.5
cross-head 1 x PH1 size 5 | 1 x PH2 size 6

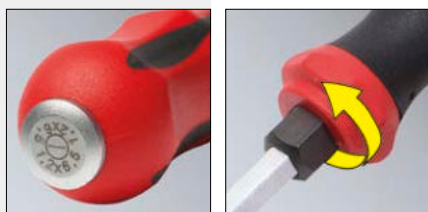

Roll repressive

Art. no.	set	kg	PU
2128	6	0,887	1

2036 TX-Screwdriver-Set



- 6 pieces:
- Security torx screwdrivers
STX 10, 15, 20, 25, 30, 40
 - chrome vanadium steel
 - matt chrome-plated blades
 - black tips
 - ergonomic octagonal curved 2-component handles with a hole



Art. no.	set	kg	PU
2036 *	6	0,569	1

1830 Claw-type gripper magnetic

Everything is under control!

- flexible claw-type gripper, length 60 cm
- ideal for gripping screws, nuts etc. that are difficult to reach
- the claw, with 'spring-action-system', can be opened up to 23 mm
- the additional magnet lifts metal parts up to 400 g
- the integrated LED allows to find dropped small-parts even in dark corners

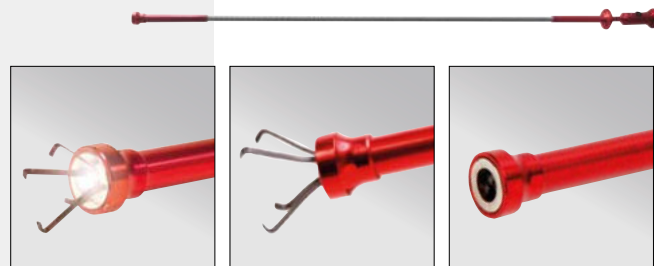

Art. no.	Length	kg	PU
1830	600	0,124	5

Bit tools



Bit tools

2142 Bit holder

1/4"

- Chrome vanadium steel
- matt chrome-plated blade, length 350 mm
- ergonomic, octagonal curved 2 component handle with a hole
- with magnet and circlip
- suitable for all bit inserts 1/4"



Art. no.	↔	Blade length	kg	VE
2142	465	350	0,170	1

2142-1 Bit holder

1/4"

- Chrome vanadium steel
- matt chrome-plated blade, length 100 mm
- ergonomic, octagonal curved 2 component handle with a hole
- with magnet and circlip
- suitable for all bit inserts 1/4"



Art. no.	↔	Blade length	kg	VE
2142-1	205	100	0,107	1

2139 Wheel ratchet for bits

Easy to handle in tight spaces

- Wheel for bits
- incl. magnet
- supplied with extension (Bits are not included)



LOOSEN



TIGHTEN

Art. no.	∅	Height	kg	PU
2139	40	20	0,099	1

2145 Bit set | 32 pieces | colour-coded

1/4"

- Supplied in a plastic box with a belt clip
- S2 steel, chrome-plated with colour-coding
- 32 pieces:
 - 1 bit holder with quick release
 - 1 adaptor for 1/4"
 - 30 bits



Content	Colour	Sizes	Pieces
cross slot Philips	⊕ (Red)	PH Gr. 1, 2, 2, 3	4
cross slot Pozidriv	⊕ (Green)	PZ Gr. 1, 2, 2, 3	4
slot	⊖ (Blue)	3, 4, 5, 6 mm	4
allen key	⊙ (Yellow)	3, 4, 5, 6 mm	4
Tx	⊗ (Orange)	Tx 10, 15, 20, 25, 27, 30, 40	7
Security Tx	⊗ (Purple)	STx 10, 15, 20, 25, 27, 30, 40	7



Art. no.	set	kg	PU
2145	32	0,247	10

Special Tools

677-1 Bath installation set "deluxe" | 16 pieces 1/2"

Scope of supply in case, 16-part set:

- S-bend connector assembly tool, 3/4"
- Corner valve screwing aid
- Universal screw bit up to 21 mm
- Valve holder for eccentric and standard valves
- Toilet seat assembly wrench
- Ratchet wrench, 4 in 1
- Combination basin cock wrench 13 mm with 5 bits 9, 10, 11, 12, 14 mm and 1 claw
- Deep hole marker for all surfaces
- Reversible ratchet, 1/2", CV steel, with internal and external square drive bit
- Hanger bolt screwdriver \varnothing 10 mm



Art. no.	set	kg	PU
677-1 *	16	3,200	1

677 Bath installation set "basic" | 6 pieces 1/2"

Supplied in a strong case, 6 pieces:

- 1 S-bend connector assembly tool, square socket for 1/2" drive
- 1 angle valve screw-in aid, square socket for 1/2" drive
- 1 universal screw insert, 1/2" drive
- 1 valve holder for rotary control and standard valves
- 1 open-end wrench 17 x 19 mm
- 1 reversible ratchet, square socket and square drive bit, 1/2" drive



Art. no.	set	kg	PU
677 *	6	3,794	1

661 WC seat installation wrench

- simple to install and remove WC seats
- universal bung wrench with more than 19 possible applications suitable for virtually all fastening systems
- thanks to cardan joint, optimal leverage
- no annoying retightening required

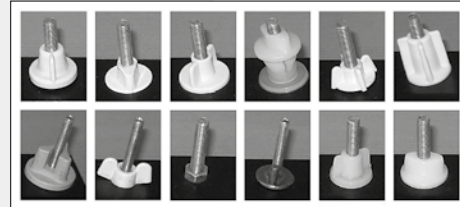

Art. no.	kg	PU
661 *	0,060	1

655 Combination washbasin tap wrench

- for all fittings up to 14 mm, size 32 mm
- 4 inserts in shank: 9, 10, 11, 12 mm + 13 mm as shank
- switchable claw with spring
- knurled handle
- Sizes 8 and 14 mm on request Art. No. 655-1/8 and 655-1/14



Art. no.	set	kg	PU
655 *	6	0,527	1

655-1 Washbasin tap wrench insert

- insert for Combination washbasin tap wrench Art. no. 645



Art. no.	span width	kg	PU
655-1/9	9	0,011	1
655-1/10	10	0,011	1
655-1/11	11	0,016	1
655-1/12	12	0,016	1
655-1/14	14	0,018	1
655-1/32	claw	0,151	1

Special Tools

665/235 Washbasin tap wrench

- for fixing nuts up to size 32 mm
- chrome vanadium steel forged
- slim shape, length 235 mm
- switchable claw with spring
- knurled handle



Art. no.	span width	kg	PU
665/235	235	0,495	1

676-1 S-connection assembly set

Consisting of:

- 1 reversible ratchet, CV steel, with 1/2" drive, with connecting square
- 1 S-connection assembly tool



Art. no.	set	kg	PU
676-1 *	2	0,873	1

676 S-connection assembly tool

- inserting and removing tool
- turns to left and right
- wear-resistant rollers
- square socket for 1/2" drive
- for all common S-connectors with 3/4" thread and SW36 drive



Art. no.	kg	PU
676	0,267	1

659 Angle valve screw-in aid

1/2"

- to screw angle valves in and out without causing any damage
- also suitable for places which are difficult to access
- inside diameter 32 mm
- square socket for 1/2" drive



Art. no.	span width	kg	PU
659	32	0,230	1

725 Valve holder

- to lock eccentric and standard sinks valves in place, when installing siphons and drains, on washbasins and sinks etc.
- with a flexible T-handle
- length 120 mm

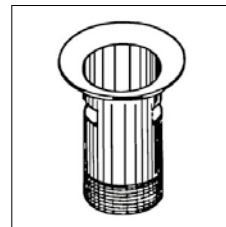

Art. no.	length	kg	PU
725 *	120	0,195	2

2845 Assembly Connection Gauge

- Supplied in an impact-resistant plastic case:
- dimensional and spatial alignment of all common installation inside dimensions 1/2" in bare brickwork
- easily readable circular bubble and with depth adjustment
- fixed adjustment increments: 75, 100, 120, 153, 200, 240 mm
- also fits for assembly rails 150 mm
- for bathtubs and shower mixers, corner and flush-mounted valves, pipe ventilators



Art. no.	kg	PU
2845	1,245	1

705/1/2 Valve extension cutter with chip collection

- for trimming 1/2" valve extensions made of red brass
- with SDS chuck adaptor
- rubber cap collects the milled chips



Art. no.	kg	PU
705/1/2	0,112	1

1362 Cartridge gun

- housing made of sheet metal, can be rotated
- suitable for 310 ml 1K cartridges
- handgrips made of aluminium
- integrated needle to clean the tip of the cartridge
- length 400 mm



Art. no.	max. Ø	max. ml	kg	PU
1362 *	51	340	0,555	1

1365 Cartridge gun

- professional cartridge holder made of sheet steel, suitable for 310 ml 1K cartridges
- wear-free, hardened and specially chrome-plated drives
- V=4 mm/stroke, thrust 1000 N
- rubber padding on the handles
- stiff and torsion-free housing
- length 410 mm



Art. no.	max. Ø	max. ml	kg	PU
1365	51	340	0,985	1

Special Tools

714 Tap reseating tool

- cylindrical shape with two compression springs
- flat milling cutter
size 1 | 3/8 - 1/2 - 3/4"
- size 1 | 3/8 - 1/2 - 3/4" - 1"



Art. no.		kg	PU
714/1	1	0,350	1
714/2	2	0,338	1

718 Replacement milling cutters

- flat design
- suitable for tap reseating tools Art. no. 714, 715



Art. no.	Inch	kg	PU
718/3/8	3/8"	0,006	10
718/1/2	1/2"	0,010	10
718/3/4	3/4"	0,021	10
718/1	1"	0,030	10

715/2 Tap reseating tool

- supplied in a metal case:
1 tap reseating tool, cylindrical shape, with two compressed springs
- flat milling cutter: 3/8", 1/2", 3/4", 1"



Art. no.	quantity	kg	PU
715/2	5	0,877	1

Tube machining



Pipe cutter

633-71/35 Carbon steel, stainless steel pipe cutter

Special pipe cutter for INOX, C-steel and Cu pipes
For pipes with Ø 3 35 mm or 1", up to 3 mm wall thickness

Body

- magnesium die casting
- especially light 1/3 lighter than aluminum | almost 1/2 lighter than zinc diecast | 200 g lighter than 633-70/35 yet as strong as zinc die-cast
- best strength/weight ratio of any metal
- magnesium as raw material sufficiently available
- easily 100 % recyclable
- modern material, increasingly also used in automotive engineering
- powdercoated (not smoothly painted), thus better feel/grip for dirty (oily, greasy)/sweaty hands

Guide rollers

- needle bearing | 2 needle bearings per roller stainless steel rollers
- no more recess for cutting close to the flange, thus optimal guiding of the Inox tube

Fast running spindle

- extra strong
- zinc die casting
- high dimensional accuracy
- high surface quality (low roughness)
- easy to machine: high accuracy

Integrated rotary deburrer

- Noga deburrer (one of the best blade manufacturers in the world)
- removable, easier deburring without moving the whole RAS

Spare cutting wheel

- Art. No. 633-75A
- size: 19 x 5 mm
- additional spare wheel in the handle !!!
- change without additional tool

Handle

- zinc die casting
- easy to bring the wheel to the tube due to the heavier zinc diecast swing whandle



Art. no.	Ø	kg	PU
633-71/35 *	3 - 35	0,335	1

Replacement parts for INOX pipe cutter 633-71/35

Art. no.	Description	PU
633-75A	Cutting wheel with needle bearing Stainless steel, carbon steel	10
633-76	Guide roller set with needle bearing	1
633-2	Deburrer	1
633-4	Wheel bolt	1

622/28 Ratchet cut | stainless steel, carbon steel

Problem-solver for pipes that are already installed

- specially for cutting stainless steel, carbon steel and copper pipe, Ø 8 - 28 mm
- the fine ratchet functions makes it easy to cut the pipes
- easy to adjust the spindle
- replacement cutting wheel Art. no. 622-1



Art. no.	Ø	kg	PU
622/28	8 - 28	0,479	1

Replacement parts for ratchet cut 622/28

Art. no.	Description	PU
622-1	Cutting wheel Stainless steel, carbon steel	5

631 Mini pipe cutter

For stainless steel, copper and brass pipes Ø 3 - 16 mm, 1/8 - 5/8"

- 1 cutting wheel Art. no. 632-1
- particularly suitable for working in places that are difficult to access



Art. no.	Ø	kg	PU
631 *	3 - 16	0,138	2

Replacement parts for mini pipe cutter 631

Art. no.	Description	PU
632-1	Cutting wheel Stainless steel, copper, brass	10
632-11	Cutting wheel Copper, brass	1
631-2	Roller	1
631-3	Roller bolts	1
631-4	Wheel bolt	1

Pipe cutter

631-5 Miniature pipe cutter

For stainless steel, copper and brass pipes \varnothing 3 – 25 mm, 1/8 – 1"
 • particularly suitable for working in places that are difficult to access



Art. no.	\varnothing	kg	PU
631-5	3 - 25	0,188	2

Replacement parts for miniature pipe cutter 631-5

Art. no.	Description	PU
632-1	Cutting wheel Stainless steel, copper, brass	10
632-11	Cutting wheel Copper, brass	1
631-52	Roller	1
631-53	Roller bolts	1
631-54	Wheel bolt	1

631-10 Compact pipe cutter

For pipes \varnothing 3 – 30 mm, 1/8 – 1 1/8"
 • particularly suitable for working in places that are difficult to access
 • 1 cutting wheel for stainless steel, copper, brass pipes Art. no. 632-1
 • 1 replacement wheel in hand wheel



Art. no.	\varnothing	kg	PU
631-10	3 - 30	0,230	1

Replacement parts for compact pipe cutter 631-10

Art. no.	Description	PU
632-1	Cutting wheel Stainless steel, copper, brass	10
632-11	Cutting wheel Copper, brass	1
631-12	Roller	1
631-13	Roller bolts	1
631-14	Wheel bolt	1

633 Pipe cutter with deburrer for stainless steel, copper and brass pipes, plastic and composite pipes

With extra strong fast running spindle

- 4-roller guide with groove for beading
- integrated rotation deburrer
- 1 cutting wheel for stainless steel, copper and brass pipes, Art. no. 632-1
- 1 cutting wheel for plastic and composite pipes, Art. no. 633-1 (only integrated in the handle of Art. no. 633/35)



Art. no.	\varnothing	kg	PU
633/35 *	3 - 32	0,336	1
633/45	9 - 45	0,620	1

Replacement parts for pipe cutter with deburrer 633

Art. no.	Description	PU
633-1	Cutting wheel Plastic, composite	10
632-1	Cutting wheel Stainless steel, copper, brass	10
632-11	Cutting wheel Copper, brass	1
633-2	Deburrer	1
633-3	Roller	1
633-4	Roller bolts	1

633-2 Deburrer | Replacement part for pipe cutter with deburrer 633

- suitable for plastic and composite pipe
- suitable for pipe cutter with deburrer Art. no. 633 and Art. no. 633-71/35



Art. no.	kg	PU
633-2	0,005	1

Pipe cutter

627 Combination pipe cutter

For pipes Ø 6 – 67 mm, 1/4 – 2 1/2"

- rapid spindle adjustment
- 1 cutting wheel for plastic and composite pipe, Art. no. 627-1
- 1 cutting wheel for stainless steel, copper, brass and hard plastic pipe (up to 2 mm), Art. no. 627-2
- replacement cutting wheel plastic, composite (up to 6 mm) Art. no. 627-1
- replacement cutting wheel plastic, composite (up to 8 mm) Art. no. 627-5
- replacement cutting wheel stainless steel, copper, brass, steel, hard plastic Art. no. 627-2
- replacement wheel bolt Art. no. 627-4



Art. no.	Ø	kg	PU
627	6 - 76	0,540	1

Replacement parts for combination pipe cutter 627

Art. no.	Description	PU
627-1	Cutting wheel Plastic, composite (up to 6 mm)	10
627-2	Cutting wheel Stainless steel, copper, brass, steel	10
627-5	Cutting wheel Plastic (larger 6 mm)	10
627-4	Wheel bolt	1

629 Pipe cutter

For steel pipes with up to 2 mm wall thickness, in particular for galvanised pipes

- body made of forged steel
- specially sprung roller guide to protect the cutting wheel



Art. no.	Ø	kg	PU
629/2	10 - 60	2,173	1
629/4	32 - 115	5,300	1

Replacement parts for pipe cutter 629-2

Art. no.	Description	PU
629-1/2	Cutting wheel Steel	10
629-2/2	Roller	1
629-3/2	Roller bolts	1
629-4/2	Wheel bolt	1

Replacement parts for pipe cutter 629-4

Art. no.	Description	PU
629-1/4	Cutting wheel Steel	3
629-2/4	Roller	1
629-3/4	Roller bolts	1
629-4/4	Wheel bolt	1

622/63 Ratchet cut | Plastic

Problem-solver for pipes that are already installed

- specially for cutting plastic pipes Ø 31 – 65 mm, up to 3 mm wall thickness
- Ideal for cutting plastic pipes in narrow shafts and with small gaps to the wall, such as when working on swimming pools



Art. no.	Ø	kg	PU
622/63	31 - 65	1,104	1

Replacement parts for ratchet cut 622/63

Art. no.	Description	PU
627-1	Cutting wheel Plastic, composite (up to 6 mm)	10

628/140 Plastic pipe cutter

- quick adjustment
- for thick-walled plastic pipes (PE, PP, PVDF) Ø 50 – 140 mm
- replacement cutting wheel Art. no. 628-1



Art. no.	Ø	kg	PU
628/140	50 - 140	1,480	1

Replacement parts for plastic pipe cutter 628

Art. no.	Description	PU
628-1	Cutting wheel Plastic, multi-layer composite	1

Cutting wheel

633-75A Cutting wheel | Stainless steel, carbon steel, copper

- replacement cutting wheel with needle bearing
- suitable for stainless steel, carbon steel, copper
- suitable for:
Art. no. 633-71/35



Art. no.	Outer Ø	Inner Ø	Thickness	kg	PU
633-75A	19	5	5	0,005	10

633-1 Cutting wheel | Plastic, composite

- replacement cutting wheel suitable for plastic, composite
- suitable for:
Art. no. 633/35
Art. no. 633/45



Art. no.	Outer Ø	Inner Ø	Thickness	kg	PU
633-1	22	5	5	0,005	10

633-75 Cutting wheel | Stainless steel, carbon steel, copper

- replacement cutting wheel with needle bearing
- suitable for stainless steel, carbon steel, copper
- suitable for:
Art. no. 633-70/35



Art. no.	Outer Ø	Innen Ø	Thickness	kg	PU
633-75	19	5	8	0,011	10

627-1 Cutting wheel | Plastic

- especially for plastic and composite pipe with up to 6 mm wall thickness and for hard plastics with up to 2 mm wall thickness
- suitable for:
Art.-no. 627
Art.-no. 622/63



Art. no.	Outer Ø	Innen Ø	Thickness	kg	PU
627-1	26	5	6	0,005	10

622-1 Cutting wheel | Stainless steel, carbon steel

- replacement cutting wheel suitable for stainless steel and carbon steel
- suitable for:
Art. no. 622/28



Art. no.	Outer Ø	Inner Ø	Thickness	kg	PU
622-1	19	6	3	0,003	5

627-2 Cutting wheel | Stainless steel

- especially for stainless steel, copper, brass, steel
- suitable for:
Art.-no. 627
Art.-no. 622/63



Art. no.	Outer Ø	Inner Ø	Thickness	kg	PU
627-2	20	5	6	0,005	10
627-5	30	5	6	0,005	10

632-1 Cutting wheel | Stainless steel, copper, brass

- replacement cutting wheel suitable for stainless steel, copper and brass
- suitable for:
Art. no. 631
Art. no. 631-5
Art. no. 631-10
Art. no. 633/35
Art. no. 633/45



Art. no.	Outer Ø	Inner Ø	Thickness	kg	PU
632-1	20	5	5	0,005	10

629-1 Cutting wheel | Steel

- suitable for:
Art. no. 629



Art. no.	Outer Ø	Inner Ø	Thickness	kg	PU
629-1/2	31	9	19	0,029	10
629-1/4	41,5	9	19	0,054	10

632-11 Cutting wheel | Copper, brass

- replacement cutting wheel suitable for Kupfer und Messing
- suitable for:
Art. no. 631
Art. no. 631-5
Art. no. 631-10
Art. no. 633/35
Art. no. 633/45



Art. no.	Outer Ø	Inner Ø	Thickness	kg	PU
632-11	20	5	5	0,055	1

628-1 Cutting wheel | Plastic

- especially for thick-walled, hard plastic and multi-layer composite pipe
- suitable for:
Art. no. 628



Art. no.	Outer Ø	Inner Ø	Thickness	kg	PU
628-1	53	8	11	0,026	1

Pipe Deburrer

647/63 Pipe deburrer plastic pipes

- for internal and external deburring of hard and thick-walled plastic pipes, Ø 25 - 63 mm
- stiff aluminium housing with special blades
- particularly suitable for swimming pool construction



Art. no.	Ø	kg	PU
647/63	25-63	0,378	1

646 Pipe deburrer

- for internal and external deburring of copper, aluminium and plastic pipes Ø 4 - 35 mm
- string plastic housing with 3 blades
- simple design



Art. no.	Ø	kg	PU
646	4-35	0,033	3

648 Pipe deburrer

- for internal and external deburring of stainless steel, brass, aluminium and plastic pipes
- robust quality tool: stiff aluminium housing and very fine deburrer blade



Art. no.	Ø	kg	PU
648/35	8-35	0,193	1
648/54	10-54	0,480	1

638 Calibration tool

- calibrator and punch
- hardened and ground
- for copper pipes without true size
- other sizes available on request



Art. no.	kg	PU
638/12	0,085	1
638/15	0,170	1
638/18	0,214	1
638/22	0,298	1

Plastic Pipe Shears

634/35 Plastic pipe scissors

- For one-hand operation with automatic blade retraction
- for Ø 6 - 35 mm
- for separating hard and soft plastic pipes, cable ducts, fibre-reinforced plastic and rubber hoses, pipes made of composite material and polypropylene
- little strength required due to ratchet technology
- straight and distortion-free, right angles cuts
- no problem blade change



Art. no.	BL	kg	PU
634/35	35	0,500	1

634-1/35 Replacement blade | Plastic pipe scissors

- blades suitable for plastic pipe scissors Art. no. 634



Art. no.	kg	PU
634-1/35	0,094	1

Pipe Bending Tools

635 Plastic pipe scissors

- with leverage transfer
- for pipes made of PVC, PE, PD, PEX, PVDF with up to 2 mm wall thickness
- for composite pipes



Art. no.	Ø	kg	PU
635/35 *	35	0,407	1
635/42	42	0,360	1

635-10 Replacement blade | Plastic pipe scissors

- blades suitable for plastic pipe shears Art. no. 635



Art. no.	Ø	kg	PU
635-10/35	35	0,083	1
635-10/42	42	0,093	1

637 Hydraulic pipe bending set | Basic metal

- Supplied in a strong plastic case:
- 1 hydraulic hand pipe bending tool
 - 5 bending segments, die-cast aluminium, 10, 12, 15, 18, 22 mm
 - 3 dollies
 - for soft copper pipes, coated copper and soft steel pipes Ø 10 – 22 mm
 - for stainless steel pipes Ø 10 – 15 mm
 - bends up to 90°
 - bending radius 4x diameter
 - to refill the oil, please use „Shell Morlina S2 BL 10“ (formerly „Shell Tellus C 10“)



Art. no.	quantity	Ø	kg	PU
637	9	10-22	5,620	1

637-10 Hydraulic pipe bending set | Combined

- Supplied in a strong plastic case:
- 1 hydraulic hand pipe bending tool
 - 9 bending segments, aluminium pressure die-casting, 10, 12, 15, 16, 18, 20, 22, 26, 32 mm
 - 5 dollies
 - for soft copper pipes, sheathed copper and soft steel pipes Ø 10 – 22 mm
 - for stainless steel pipes Ø 10 – 15 mm
 - for composite pipes Ø 12 – 32 mm
 - bends up to 90°
 - bending radius 4 x diameter
 - to refill the oil, please use „Shell Morlina S2 BL 10“ (formerly „Shell Tellus C 10“)



Art. no.	quantity	Ø	kg	PU
637-10	15	10 - 32	8,404	1

BRINKKO[®]
powered by **haupa**

Pipe Bending Tools

637-20 Hydraulic pipe bending set | Basic composite

Supplied in a strong plastic case:

1 hydraulic hand pipe bending tool

4 bending segments, die-cast aluminium, 16, 20, 26, 32 mm

4 dollies

- for composite pipes \varnothing 12 - 32 mm
- bends up to 90°
- bending radius 4 x diameter
- to refill the oil, please use „Shell Morlina S2 BL 10“ (formerly „Shell Tellus C 10“)



Art. no.	quantity	\varnothing	kg	PU
637-20	9	16 - 32	7,433	1

637-6 Dollies

- relevant dollies for hydraulic pipe bending devices
- replacement screws, Art. no. 637-4
- replacement nuts, Art. no. 637-2



Art. no.	\varnothing	kg	PU
637-6/1	10 - 12	0,334	1
637-6/2	14 - 17	0,363	1
637-6/3	18 - 22	0,452	1
637-6/4	26	0,452	1
637-6/5	32	0,452	1

637-1 Bending segment pipes

- bending segments of aluminium injection moulding suitable for hydraulic pipe bending devices
- bending radius 4x diameter



Art. no.	\varnothing	kg	PU
637-1/10	10	0,099	1
637-1/12	12	0,112	1
637-1/14	14	0,125	1
637-1/15	15	0,127	1
637-1/16	16	0,140	1
637-1/17	17	0,142	1
637-1/18	18	0,187	1
637-1/20	20	0,190	1
637-1/22	22	0,200	1
637-1/26	26	0,099	1
637-1/32	32	0,099	1

636-1 Copper pipe bending pliers

- for soft copper pipes and chrome-plated copper pipes
- for bending up to 180°
- with graduation on bending segment
- light design



Art. no.	\varnothing	kg	PU
636-1/10	10	0,799	1
636-1/12	12	0,828	1

701 Copper pipe bending springs

- galvanised
- for bending by hand
- for soft and soft chrome-plated copper



Art. no.	→	\varnothing	kg	PU
701/8	250	8-8	0,107	5
701/10	250	10-10	0,123	5
701/12	300	12-12	0,170	5
701/15	300	15-15	0,268	5
701/16	300	16-16	0,272	5

Pipe Cleaning Tools



Pipe Cleaning

3722 Pipe cleaning pump

- Suction and pressure cleaner for blocked pipes
- short attachment for washbasins and sinks
- long attachment for WC



Art. no.	kg	PU
3722 *	1,700	1

3720 Pipe cleaning tool

- Cleaning tool for manual and machine operation
- for pipes Ø 30 – 50 mm
- shaft made of galvanised spring steel, 7.5 m x 8 mm
- strong plastic housing with handle
- hexagonal shank to clamp into rotational speed controlled electric drill or cordless screwdriver
- can be locked into place and any length with a quick clamp chuck Art. no. 3720-2



Art. no.	l	Ø mm	kg	PU
3720	7,5 cm	30 – 50	3,500	1

3720-1 Replacement shaft

- suitable for pipe cleaning device Art. no. 3720
- galvanised spring steel
- 7.5 m x 8 mm



Art. no.	l	kg	PU
3720-1	7,5	2,000	1

3720-2 Quick release chuck

- suitable for pipe cleaning device Art. no. 3720



Art. no.	kg	PU
3720-2	0,177	1

7640 Pressure testing pump

- for safe tightness testing on water pipes
- brass piston, 1/2" hose connection
- test pressure up to 60 bar
- storage tank 12 l, painted red
- tank dimensions 500 x 180 x 140 mm
- replacement manometer Art. no. 7640-1
- replacement pressure hose Art. no. 7640-2



Art. no.	kg	PU
7640	7,800	1
7640-1	0,070	1
7640-2	0,727	1

Pipe Cleaning

7641 Pressure testing pump stainless steel

- for safe tightness testing on pipes
- in particular with chemically contaminated, aggressive liquids
- also suitable for solar panel systems and underfloor heating systems
- 1/2" hose connection
- test pressure up to 60 bar
- storage tank 12 l made of STAINLESS STEEL
- per stroke 0.027 litres
- tank dimensions 500 x 190 x 140 mm
- replacement manometer Art. no. 7641-1
- replacement pressure hose Art. no. 7640-2



Art. no.		kg	PU
7641	testing pump 60 bar	6,400	1
7641-1	manometer 60 bar	0,070	1

3700 Pipe cleaning shaft

- single layer
- for household use and simple work



Art. no.	m	Ø mm	kg	PU
3700/3 *	3	5	0,279	1
3700/5	5	5	0,652	1

3701 Pipe cleaning shaft

- single layer
- for simple work



Art. no.	m	Ø mm	kg	PU
3701/3	3	9	1,085	1
3701/5	5	9	1,398	1
3701/10	10	9	3,472	1

3714 Pipe cleaning shaft

- 3/8" Whitworth thread
- crank can be replaced
- fixed claw
- coupling made of steel
- rotary hand protection



Art. no.	m	Ø mm	kg	PU
3714/5	5	8	1,700	1
3714/10	10	8	3,200	1

3702 Pipe cleaning shaft

- double layer
- adjustable handle



Art. no.	m	Ø mm	kg	PU
3702/5 *	5	7	1,250	1
3702/8	8	7	1,897	1

3712 Pipe cleaning shaft

- 1/2" Whitworth thread
- claw and crank can be replaced
- couplings made of steel
- rotary hand protection



Art. no.	m	Ø mm	kg	PU
3712/5x10	5	10	2,750	1
3712/5x15	5	15	3,740	1
3712/10x12	10	12	7,200	1
3712/10x15	10	15	11,300	1

BRINKO
powered by haupa®

Pipe Cleaning

3713 Shaft extension

- 1/2" Whitworth thread
- suitable for pipe cleaning shaft Art. no. 3712



Art. no.	→ m	∅ mm	kg	PU
3713/5x10	500 cm	10	2,750	1
3713/5x12	500 cm	12	3,400	1
3713/10x10	1000 cm	10	4,700	1
3713/10x12	1000 cm	12	6,500	1

3730 Water pressure drain cleaner

- Ingeniously removes blockages in drainpipes with high pressure water
- for pipes ∅ 40 - 150 mm
- including 1.5 m hose with adaptor, hose connection 1/2" x 3/4" IG
- patented pressure balloon

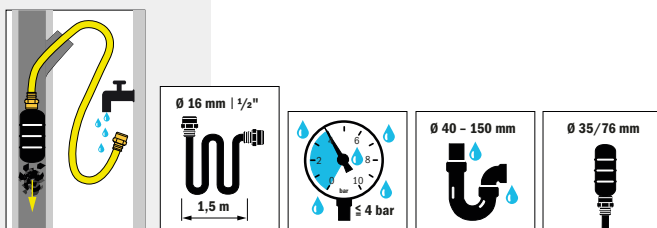

Art. no.	Balloon ∅	Tube ∅	kg	PU
3730/1	35	40 - 80	0,370	1
3730/2	76	80 - 150	0,627	1

3800-1 Sealing balloon

- easily seal pipes
- pneumatic sealing system for various pipe diameters
- suitable for compressed air hose Art. no. 3800-2

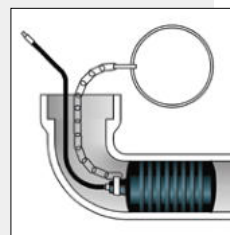

Art. no.	Tube ∅	→ mm	kg	PU
3800-1/1	30 - 50	140	0,137	1
3800-1/2	50 - 80	135	0,210	1
3800-1/3	70 - 100	120	0,276	1
3800-1/4	90 - 150	230	0,722	1

3800-2 Compressed air hose

- Extension hose for sealing bubbles
- can be extended as required
- length 3 m



Art. no.	→ m	kg	PU
3800-2	3	0,330	1

3800-3 Air pump with manometer

- suitable for sealing bubbles Art. no. 3800-1



Art. no.	kg	PU
3800-3	1,554	1

3806 Plug for inner pipe

Original Gripper - tested and proven, the most preferred mechanical shut-off discs on the market

- for unpressurized lines, seals only in the inner tube, can be placed as required

Maximum Counter Pressure 1,2 bar corresponds to a 12 m water column

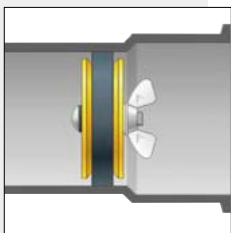

Art. no.	Tube Ø	kg	PU
3806/1	96 - 103	0,000	1
3806/2	147 - 154	0,802	1
3806/3	196 - 204	1,002	1

3805 Plug for end pipe

Original Gripper - tested and proven, the most preferred mechanical shut-off discs on the market

- for unpressurized lines, seals only at the pipe end, does not fall into the inner pipe

Maximum Counter Pressure 1,2 bar corresponds to a 12 m water column

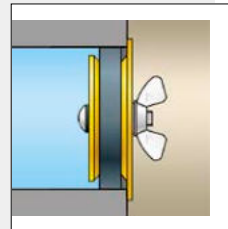

Art. no.	Tube Ø	kg	PU
3805/1	39 - 42	0,075	1
3805/2	49 - 55	0,100	1
3805/3	71 - 79	0,229	1
3805/4	96 - 103	0,295	1
3805/5	147 - 154	0,812	1

Inspection systems



3740 Pressure testing pump

Inspection system for pipes, sewers, and house connections

BASIC CONFIGURATION

- STANDARD Ø 26 mm camera head, self-levelling
- with integrated 512 Hz transmitter, strong signals and easier to be located
- STANDARD Ø 6 mm camera cable | length 60 m strong and solid
- incl. frame and digital metre counter
- 10-inch TFT monitor with high resolution, very clear
- digital recording function with both USB and SD card (photo, video, dictation function)
- has function buttons on the front panel and has a remote control
- Text processing function
- watertight ABS outdoor case
- measuring range/area of application DN 50 - 125
- battery safety test certificates



Art. no.	kg	PU
3740	13,313	1

3740-1 STANDARD camera head

- STANDARD Ø 26 mm camera head
- self-levelling
- with integrated 512 Hz transmitter
- Measuring range/area of application DN 50 - 125 mm



Art. no.	kg	PU
3740-1	0,186	1

3740-2 STANDARD camera cable

- STANDARD Ø 6 mm camera cable | length 60 m
- incl. frame and metre counter
- for STANDARD camera head



Art. no.	kg	PU
3740-2	8,013	1

3740-3 Guide starwheel 100 mm

- for pipe diameter Ø 100 mm
- for STANDARD camera head



Art. no.	kg	PU
3740-3	0,093	1

3740-4 Control station

- 10-inch TFT monitor
- multifunction control
- digital recording function on USB/SD (photo, video, dictation function)
- text processing function
- watertight ABS outdoor case



Art. no.	kg	PU
3740-4	5,114	1

Inspection systems

3740-5 Replacement monitor

- 10-inch TFT monitor
- for control station



Art. no.	kg	PU
3740-5	1,730	1

3740-6 Power supply

- power supply 230 V for charging the control station



Art. no.	kg	PU
3740-6	0,114	1

3740-7 Centring aid | starwheel

- Pack content 10 pcs.
- incl. 5 replacement silicone sticks
- for STANDARD camera head



Art. no.	kg	PU
3740-7	0,015	10

3740-8 Connecting cable | 4-core

- connecting cable between control station and STANDARD Ø 6 mm or SMALL Ø 4.5 mm camera cable | length 1.5 m



Art. no.	kg	PU
3740-8	0,161	1

3750 SMALL camera head set

Small Ø 13.5 mm camera head, suitable for inspection system or pipe, sewer, and house connections

- SMALL Ø 13.5 mm camera head
- SMALL Ø 4.5 mm camera cable | length 10 m
- incl. reel and metre counter
- Measuring range/area of application DN 10 – 50

Only to be used in connection with the pipe inspections camera set Art. no. 3740 (basic equipment)!



Art. no.	kg	PU
3750	1,287	1

3750-1 SMALL camera head

- SMALL Ø 12 mm camera head
- incl. guiding ball
- Measuring range/area of application 10 – 50 mm



Art. no.	kg	PU
3750-1	0,035	1

BRINKO[®]
powered by **haupa**[®]

3750-2 SMALL camera cable

- SMALL Ø 4.5 mm camera cable | length 10 m
- incl. reel and metre counter



Art. no.	kg	PU
3750-2	1,086	1

3750-3 Guiding ball

- scope of delivery 1 pc
- incl. replacement screws
- for SMALL camera head



Art. no.	kg	PU
3750-3	0,004	1

3760 SWIPUL-MOUNTED camera head set

Swivel-mounted Ø 60 mm camera head, suitable for inspection system or pipe, sewer, and house connections

- SWIPUL-MOUNTED Ø 60 mm camera head
- Swivel range 360°|180°
- with integrated 512 Hz transmitter
- SWIPUL-MOUNTED Ø 9 mm camera cable | length 60
- incl. frame and metre counter
- Measuring range/area of application DN 70 - 450

Only to be used in connection with the pipe inspections camera set Art. no. 3740 (basic equipment)!



Art. no.	kg	PU
3760	2,456	1

3760-1 SWIPUL-MOUNTED camera head

- SWIPUL-MOUNTED Ø 60 mm camera head
- Swivel range 360°/180°
- with integrated 512 Hz transmitter
- Measuring range/area of application DN 70 - 450 mm



Art. no.	kg	PU
3760-1	0,369	1

Inspection systems

3760-2 SWIPUL-MOUNTED camera cable

- SWIPUL-MOUNTED Ø 9 mm camera cable | length 60/100 m
- incl. frame and metre counter
- für SWIPUL-MOUNTED camera head



Art. no.	kg	PU
3760-2/60	23,800	1
3760-2/100	35,410	1

3760-3 Connecting shaft

- connecting shaft between camera cable and SWIPUL-MOUNTED camera head



Art. no.	kg	PU
3760-3	0,395	1

3760-5 Plastic protective cap

- incl. seal
- for SWIPUL-MOUNTED camera head



Art. no.	kg	PU
3760-5	0,015	1

3760-6 Metal protective grid

- to protect the plastic protective cap
- for SWIPUL-MOUNTED camera head



Art. no.	kg	PU
3760-6	0,029	1

3760-7 Guide starwheel 100 mm

- for SWIPUL-MOUNTED camera head



Art. no.	Ø	kg	PU
3760-7/1	100	0,206	1
3760-7/2	125	0,230	1
3760-7/3	150	0,247	1

3760-8 Connecting cable | 6-Kern

- Connecting cable between control station and SWIPUL-MOUNTED Ø 9 mm camera cable | length 5 m



Art. no.	kg	PU
3760-8	0,212	1

BRINKKO[®]
powered by **haupa**

Soldering

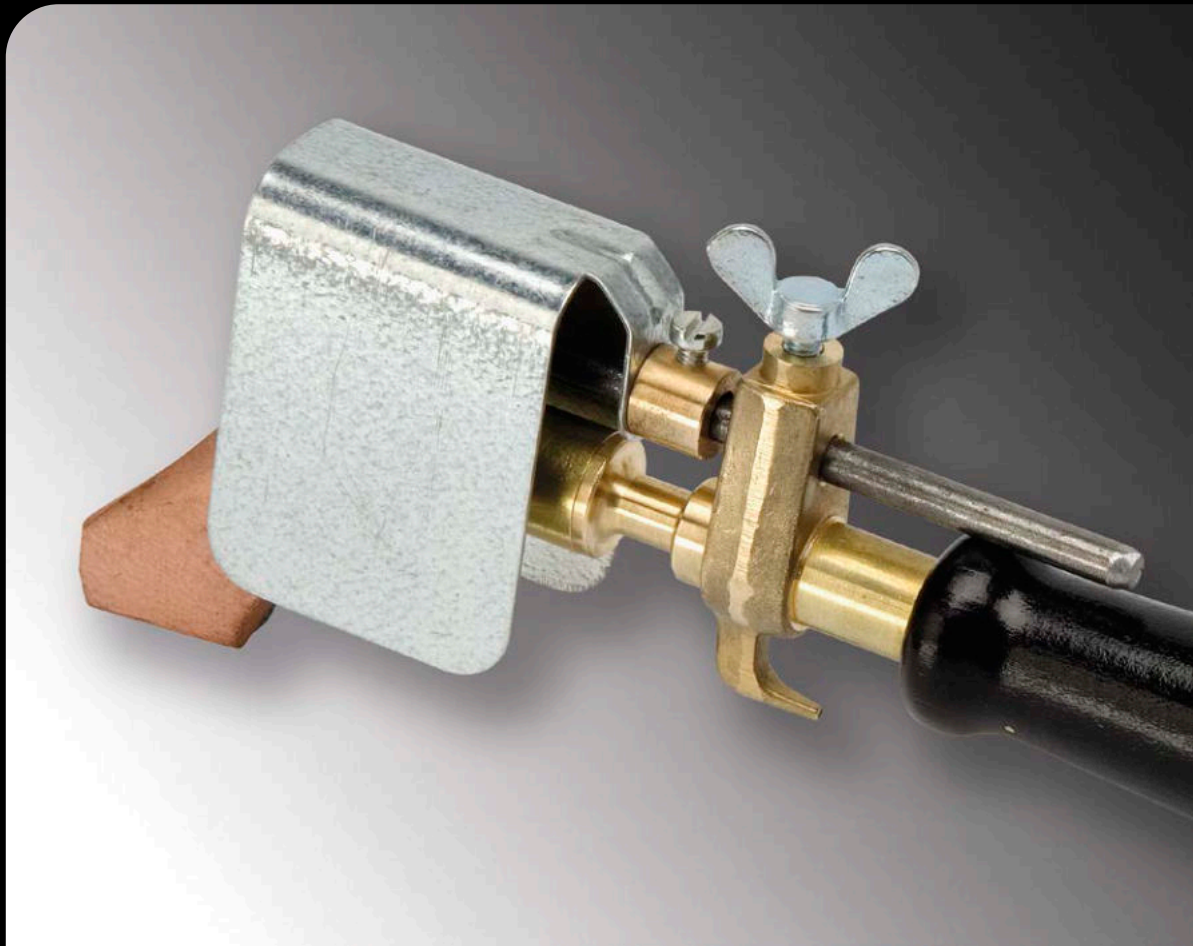

Piston brazing

4426 Propane soldering iron

Consisting of:

- handle, hose connection G 3/8" LH Art. no. 4427
- iron stand Art. no. 4428
- soldering torch Art. no. 4429
- wind protection Art. no. 4430
- copper piece, 250 g Art. no. 4435/250

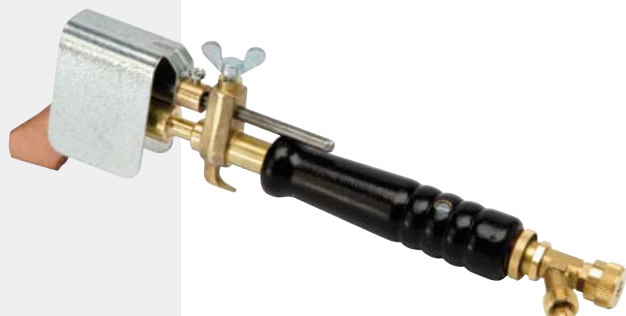

Art. no.	quantity	kg	PU
4426	5	0,296	1

4427 Propan handle

- without grommet and union nut
- hose connection G 3/8" LH



Art. no.	kg	PU
4427	0,302	1

4429 Soldering torch

- suitable for propan handle Art. no. 4427



Art. no.	kg	PU
4429	0,059	2

4429-1/5 Soft solder insert

- curved 40°
- gas port Ø 5 mm
- suitable for propan handle Art. no. 4427



Art. no.	kg	PU
4429-1/5	0,087	2

4428 Iron stand

- suitable for soldering iron Art. no. 4426



Art. no.	kg	PU
4428	0,082	2

4430 Wind protection

- suitable for soldering iron Art. no. 4426



Art. no.	kg	PU
4430	0,087	2

Piston brazing

4435 Copper piece

- angled hammer shape
- 7 mm pin



Art. no.	kg	PU
4435/250	0,296	2
4435/350	0,388	2

4436 Copper piece

- pointed shape
- 7 mm pin



Art. no.	kg	PU
4436/250	0,298	2
4436/350	0,388	2

Soft and hard soldering

4400 Propane handle

- with regulator and level valve
- outlet M14 x 1
- hose connection G 3/8 „ LH



Art. no.	kg	PU
4400	0,352	1

4405 Soft solder insert

- 1400 °C
- with union nut M14 x 1
- suitable for propane handles Art. no. 4400
- 1,5 bar



Art. Nr.	Ø	Cu Ø	kg/h	kg	PU
4405/5	5	15 - 22	0,070	0,103	1
4405/7	7	22 - 28	0,150	0,170	1

4406 Propane hard solder insert

- operating pressure 1.5 - 2.5 bar
- union nut M14 x 1
- 1600 - 1700 °C
- suitable for propane handles Art. no. 4400



Art. Nr.	Gas outlet Ø	Cu Ø	kg/h	kg	PU
4406	16	18	0,065	0,096	1
4407	19	22	0,140	0,103	1
4408	22	28	0,000	0,247	1

Accessories For Pressure Bottles

4443 Miniature propane bottle

- Steel body design approved
- complete with stand, hook, valve and sealing cap
- connection G 3/8" LH
- filling weight 0.425 kg (supplied empty!)



Art. no.	kg	PU
4443	2,500	1

4443-1 Sealing cap

- legally required as transport safeguard
- suitable for miniature propane bottle Art. no. 4443



Art. no.	kg	PU
4443-1	0,014	1

4443-2 Protective bracket

- suitable for miniature propane bottle Art. no. 4443



Art. no.	kg	PU
4443-2	0,482	2

4444 Miniature propane bottle valve

- Design approval no. 82D166 (only for steel bottles)
- connection G 3/8" LH
- outer Ø 1/2"
- suitable for miniature propane bottle Art. no. 4443

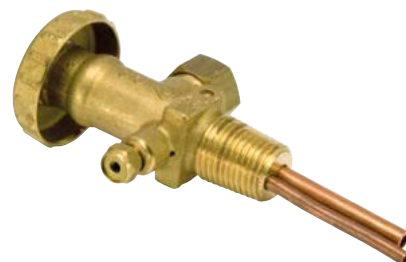

Art. no.	kg	PU
4444	0,253	1

4446 Propane filler pipe

- Bottle connection from 5, 11 and 33 kg to miniature bottles
- large connection W 21.8 x 1/14" LH
- small connection G 3/8" LH
- suitable for miniature propane bottle Art. no. 4443

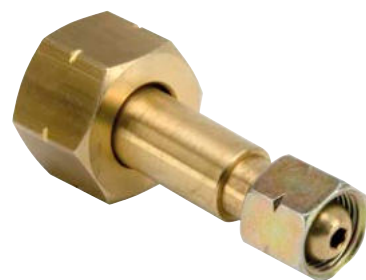

Art. no.	kg	PU
4446	0,149	2

4447-0 Propane medium pressure regulator

- certified according to DIN 4811
- working pressure can be regulated from 0.5 - 4 bar
- **for miniature bottles**
- output 8 kg/h
- outlet outer thread G 3/8" LH



Art. no.	kg	PU
4447-0	0,340	1

Accessories For Pressure Bottles

4447 Propane medium pressure regulator

- certified according to DIN 4811
- working pressure can be regulated from 0.5 - 4 bar
- combination connection for 3, 5, 11 and 33 kg bottles
- output 8 kg/h
- outlet outer thread G 3/8" LH



Art. no.	kg	PU
4447	0,260	1

4447-1 Propane medium pressure regulator

- certified according to DIN 4811
- working pressure can be regulated from 0.5 - 4 bar
- with manometer
- combination connection for 3, 5, 11 and 33 kg bottles
- output 8 kg/h
- outlet outer thread G 3/8" LH



Art. no.	kg	PU
4447-1	0,310	1

4447-11 Propane working manometer

- Propane working manometer 4 bar
- suitable for propane medium pressure regulator Art. no. 4447-1, 4447-10



Art. no.	kg	PU
4447-11	0,042	1

4452 High pressure hose

- 4 x 4 mm
- completely reinforced
- bursting pressure 30 bar,
- operating pressure 10 bar
- connections G 3/8" LH



Art. no.	m	kg	PU
4452/1,5	1,5	0,280	1
4452/2	2	0,364	1
4452/3	3	0,660	1
4452/5	5	0,774	1

Solder Sets & Blowtorches

4399 Propane soft solder set

Consisting of:

- propane handle G 3/8" LH
- soft solder insert 40° curved, Ø 5 mm
- high pressure hose 3 m
- miniature propane bottle 425 g



Art. no.	quantity	kg	PU
4399	4	3,549	1

4398 Propane soft solder set

Consisting of:

- soldering iron G 3/8" LH
- high pressure hose 3 m
- miniature propane bottle 425 g



Art. no.	quantity	kg	PU
4398	3	3,456	1

4394 Propane soft solder set

Consisting of:

- propane handle G 3/8" LH
- soft solder insert 40° curved, Ø 5 mm
- high pressure hose 3 m
- miniature propane bottle 425 g, filler pipe
- gas lighting tongs



Art. no.	quantity	kg	PU
4394	6	5,500	1

4395 Propane soft solder set

Consisting of:

- soldering iron G 3/8" LH
- soft solder inserts 40° curved, Ø 5 and 7 mm
- miniature propane bottle 425 g, filler pipe
- high pressure hose 3 m and gas lighting tongs



Art. no.	quantity	kg	PU
4395	5	6,300	1

Solder Sets & Blowtorches

5000 Soldering tool

- with automatic Piezo ignition, temperature 1800 °C
- can also be used overhead after a short heating period
- for soft- and hard soldering copper pipe Ø 18 - 22 mm
- including mixed gas cartridge (butane/propane), filling 330 g | 600 ml
Art. no. 5100



Art. no.	°C	kg	PU
5000 *	1800	0,488	1

5100/350 Gas cartridge

- suitable for soldering device Art. no. 5000
- mixed gas (butane/propane) 330 g | 600 ml
- with self-sealing safety valve



Art. no.	kg	PU
5100/350 *	0,488	12

5205 Blowtorch

- for soft-soldering
- Piezo ignition, temperature up to 1200 °C
- high performance torch, high quality stainless steel
- gas consumption can be regulated using rotating gas tap, maximum 86 g/h
- including mixed gas cartridge
- can also be used overhead after a short heating period
- suitable replacement mixed gas cartridge Art. no. 5210



Art. no.	°C	kg	PU
5205	1200	0,277	1

5200 Blowtorch

- for soft soldering and brazing
- temperature up to 1750 °C
- centrally bundled flame
- high performance torch Ø 21 mm
- impact-resistant plastic housing, design approval no. 02/121
- suitable replacement mixed gas cartridge Art. no. 5210



Art. no.	°C	kg	PU
5200 *	1750	0,277	1

BRINKKO
powered by **haupa**

Solder Sets & Blowtorches

5210 Mixed gas cartridge

- mixed gas filling (butane/propane), 190 g
- suitable for blowtorches Art. no. 5200 and 5205



Art. no.	kg	PU
5210 *	0,277	10

Solder Accessories

1649 Ammonia stone

- 2 ammonia stones each 64 x 45 x 20 mm



Art. no.	kg	PU
1649	0,100	2

8080 Flame protection mat

- dimension 330 x 500 mm
- high quality, non melting fibre fleece, asbestos-free
- 2-layer quilted
- extremely flexible
- can be used up to 1000 °C, briefly up to 1500 °C



Art. no.	Length	Width	kg	PU
8080	500	330	0,330	5

Solder Accessories

8030 Magnetic control mirror

- with permanent magnet, holding surface flat and prismatic
- flexible metal hose with ball joint
- steel mirror, rectangular 80 x 70 mm, polished nickelplated



Art. no.	Thickness	Width	Height	kg	VE
8030/1,0	1,0	70	80	0,466	1
8030/1,5	1,5	70	80	0,450	1

8061 Steel mirror

- Steel, polished nickel-plated
- rectangular 80 x 70 mm
- suitable for magnetic control mirror Art. no. 8030



Art. no.	Thickness	Width	Height	kg	VE
8061/1,0	1,0	70	80	0,066	10
8061/1,5	1,5	70	80	0,066	10

2999 Solder water brush

- with sheet metal sheath and natural bristles



Art. no.	kg	PU
2999	0,002	50

4200 Gas lighting tongs

- with roller file
- including flint, Art. no. 4201



Art. no.	kg	PU
4200	0,051	10

1636/40 Solder

- with 40 % tin content
- triangular



Art. no.	Tin %	kg	PU
1636/40	40	1,000	1

1644 Solder wire

- for soft soldering
- with 40 % tin content



Art. no.	l	Tin %	Ø	kg	PU
1644/250	10	40	2	0,259	6
1644/500	20	40	2	0,518	6

Solder Accessories

1645/20 Resin quick solder

- special solder wire (radio solder) for electrical engineering
- with prepared resin core
- 40 % tin content
- winder with wire Ø 2mm, 20 g



Art. no.	Tin %	Ø	kg	PU
1645/20	40	2	0,021	24

1646/500 Resin quick solder

- special solder (radio solder) for electrical engineering
- with prepared resin core
- 40 % tin content
- Roll with wire Ø 2 mm
- 500 g, 20 m



Art. no.	m	Tin %	Ø	kg	PU
1646/500	20	40	2	0,530	6

1646-1 Resin quick solder

- special solder (radio solder) for electrical engineering
- with a prepared resin
- 60 % tin content



Art. no.	m	Tin %	Ø	kg	PU
1646-1/250-1,0	4	60	1	0,259	6
1646-1/500-1,0	8	60	1	0,529	6
1646-1/500-1,5	4	60	1,5	0,528	6

1638/150 Solder water bottle

- made of unbreakable, acid and chemical-resistant polyethylene
- base 60 x 60 mm, height 85 mm
- without content
- possible filling quantity 150 ml



Art. no.	kg	PU
1638/150	0,037	1

1640/150 Hydrochloric acid bottle

- made of unbreakable, acid and chemical-resistant polyethylene
- base 60 x 60 mm, height 85 mm
- without content
- possible filling quantity 150 ml



Art. no.	kg	PU
1640/150	0,040	1

Welding



4080 Pressure relief valve | Oxygen

- for oxygen
- with content manometer 200 kp/cm²
- with working manometer 10 kp/cm²



Art. no.	kg	PU
4080	1,330	1

4090 Pressure relief valve | Acetylene

- for fuel gas (acetylene)
- with content manometer 18 kp/cm²
- with working manometer 1.5 kp/cm²
- with bracket connection

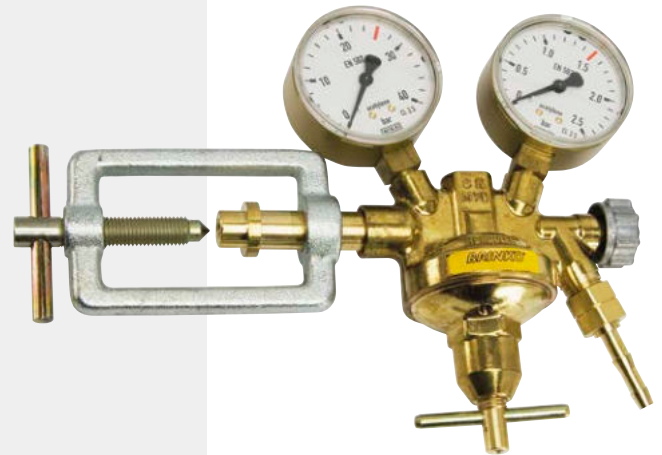

Art. no.	kg	PU
4090	1,630	1

4081 Working manometer

- for oxygen
- 10 kp/cm²



Art. no.	kg	PU
4081	0,136	1

4091 Working manometer

- for fuel gas (acetylene)
- 1.5 kp/cm²



Art. no.	kg	PU
4091	0,133	1

4082 Content manometer

- for oxygen
- 200 kp/cm²



Art. no.	kg	PU
4082	0,138	1

4092 Content manometer

- for fuel gas (acetylene)
- 18 kp/cm²



Art. no.	kg	PU
4092	0,141	1

Oxyacetylene welding

4073 Double oxyacetylene hose

- bursting pressure 60 bar, operating pressure 20 bar
- with a steel clamp every metre
- outer Ø 13 mm
- inner Ø 6 mm
- installed connections:
 - G 3/8" LH, red for fuel gas (acetylene)
 - G 1/4", blue for oxygen

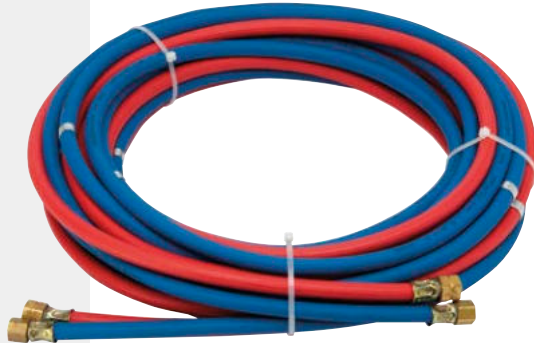

Art. no.	m	kg	PU
4073/10	10	3,500	1
4073/20	20	6,900	1

3902 Handle

- light alloy, anodised
- valve handwheel for single handed use
- shank Ø 20 mm



Art. no.	kg	PU
3902	0,639	1

3902-3 Spare-Connection nut

- suitable for handle Art. no. 3902



Art. no.	kg	PU
3902-3	0,049	1

4070 Explosion protection safeguard

- for oxygen
- with flame barrier and gas non-return valve
- cut-off valve and dirt filter
- connecting thread G 1/4"
- to connect to a pressure regulator
- Serial number available on request



Art. no.	kg	PU
4070	0,250	1

4071 Explosion protection safeguard

- for fuel gas (acetylene)
- with flame barrier and gas non-return valve
- cut-off valve and dirt filter
- connecting thread G 3/8" LH
- to connect to a pressure regulator
- Serial number available on request



Art. no.	kg	PU
4071	0,250	1

4005 Nozzle cleaning drill set

- 11 cleaning drills
- for cutting nozzles and welding inserts
- Ø 0.5 - 1.6 mm



Art. no.	kg	PU
4005	0,030	1

Oxyacetylene welding

Welding insert

- nickel plated
- shank Ø 20 mm



Art. no.	welding range	kg	PU
3922/1-2	1 - 2	0,116	1
3923/2-4	2 - 4	0,133	1
3924/4-6	4 - 6	0,142	1
3925/6-9	6 - 9	0,215	1
3926/9-14	9 - 14	0,230	1

Pipe welding insert

- bendy copper pipe
- shank Ø 20 mm



Art. no.	welding range	kg	PU
3936/1-2	1 - 2	0,080	1
3937/2-4	2 - 4	0,081	1
3938/4-6	4 - 6	0,080	1
3939/6-9	6 - 9	0,079	1

Replacement tip

- bendy copper pipe



Art. no.	W welding range	for Art. no.	kg	PU
3946/1-2	1 - 2	3936/1-2	0,038	1
3947/2-4	2 - 4	3937/2-4	0,039	1
3948/4-6	4 - 6	3938/4-6	0,039	1
3949/6-9	6 - 9	3939/6-9	0,043	1

Sealing accessories

3820 Hemp dispenser

- approx. 80 g hemp coil
- in plastic box



Art. no.	kg	PU
3820	0,104	5

3825 Hemp coil

- approx. 80 g hemp coil



Art. no.	kg	PU
3825	0,090	10

Drilling

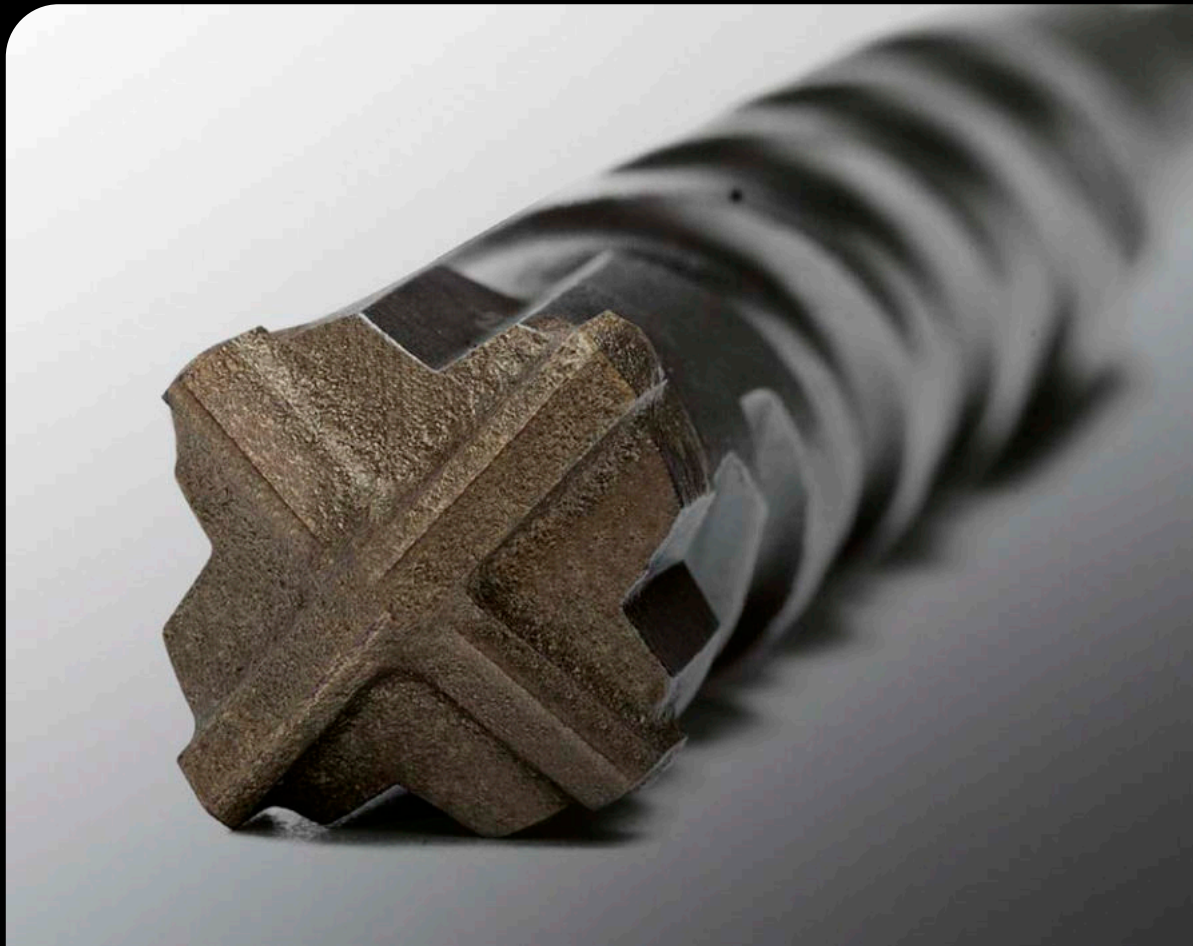

Drills & Sets

1044 Twist drill

- HSS, DIN 338
- fully ground, split point
- blank



Art. no.	Ø	kg	PU
1044/1,0	1	0,005	10
1044/1,5	1,5	0,008	10
1044/2,0	2	0,001	10
1044/2,5	2,5	0,018	10
1044/3,0	3	0,003	10
1044/3,5	3,5	0,004	10
1044/4,0	4	0,005	10
1044/4,5	4,5	0,007	10
1044/5,0	5	0,009	10
1044/5,5	5,5	0,011	10
1044/6,0	6	0,014	10
1044/7,0	7	0,021	10
1044/6,5	6,5	0,017	10
1044/7,5	7,5	0,024	10
1044/8,0	8	0,029	10
1044/8,5	8,5	0,033	5
1044/9,0	9	0,042	5
1044/9,5	9,5	0,046	5
1044/10,0	10	0,010	5
1044/10,5	10,5	0,060	5
1044/11,0	11	0,070	5
1044/11,5	11,5	0,076	5
1044/12,0	12	0,082	5
1044/12,5	12,5	0,096	5
1044/13,0	13	0,102	5

1060 Twist drill set

- HSS
- supplied in plastic box



Art. no.	set	Ø	kg	PU
1060/2	19	1 - 10	0,694	1
1060/3	25	1 - 13	1,307	1

1065 Twist drill set

- supplied in round plastic tub: 19 HSS twist drills
- drilling Ø 1 - 10 mm, increment 0.5 mm



Art. no.	set	Ø	kg	PU
1065	19	1 - 10	0,449	1

1366-2 T.C.T. stone drill

- round shank
- milled and ground special design
- particularly strong carbide small plate
- straight spiral inlet and negative chamfer
- for rotating and hammer drilling
- areas: natural stone, concrete, tiles, glass, ceramic etc.



Art. no.	Length	Ø	kg	PU
1366-2/6	120	6	0,019	10
1366-2/8	130	8	0,032	10
1366-2/10	140	10	0,052	10
1366-2/14	155	14	0,120	5

Drills & Sets

1374 T.C.T. hammer drill

- powerful, fast and durable
- SDS-Plus chuck adaptor
- crosshead, 4 edges:
- long tool life
- easy, quick work
- avoids drill bit tilting
- effective drilling dust removal



Art. no.	→→→	Ø	kg	PU
1374/110x6 *	110	6	0,033	10
1374/160x5	160	5	0,045	10
1374/160x6 *	160	6	0,048	10
1374/160x8 *	160	8	0,053	10
1374/160x10	160	10	0,070	10
1374/160x12	160	12	0,083	5
1374/160x14	160	14	0,114	5
1374/160x15	160	15	0,114	5
1374/210x8	210	8	0,074	5
1374/210x10 *	210	10	0,090	5
1374/210x12 *	210	12	0,110	5
1374/210x14	210	14	0,000	5
1374/210x16	210	16	0,164	5
1374/210x18 *	210	18	0,192	5
1374/460x10 *	460	10	0,195	1
1374/460x12	460	12	0,242	1
1374/460x14 *	460	14	0,316	1
1374/460x16	460	16	0,383	1
1374/460x18	460	18	0,512	1
1374/460x20	460	20	0,574	1
1374/460x24 *	460	24	0,790	1
1374/600x12	600	12	0,260	1
1374/600x16	600	16	0,506	1

1045/3,2 Double-ended drill bit

- HSS
- drilling Ø 3.2 mm
- for predrilling, e.g. aluminium rivets and copper rivets



Art. no.	Ø	kg	PU
1045/3,2	3,2	0,004	10

1368-1 Glass tile drill

Single Drill

- optimally designed for cordless power tools
 - 1/4" hexagonal shaft
 - pointed chisel edge enables precision drilling, can be re-sharpened
- Please note: Only use in rotation (low rotation speed) and in sufficiently cool.**

Areas: ceramics, tiles, hard-fired tiles, glass, acrylic glass, mirror glass



Art. no.	Ø	Shaft Ø	kg	PU
1368-1/5	5	6,35	0,009	1
1368-1/6 *	6	6,35	0,011	1
1368-1/8 *	8	6,35	0,015	1
1368-1/10 *	10	6,35	0,258	1
1368-1/13	13	6,35	0,300	1
1368-1/14	14	6,35	0,350	1

1368 Glass tile drill set

5-piece

- Sizes: 2 x 6, 2 x 8.1 x 10 mm
- optimally designed for cordless power tools
- 1/4" hexagonal shaft
- pointed chisel edge enables precision drilling, can be re-sharpened

Please note: Only use in rotation (low rotation speed) and in sufficiently cool.

Areas: ceramics, tiles, hard-fired tiles, glass, acrylic glass, mirror glass



Art. no.	set	Ø	kg	PU
1368 *	5	6 - 10	0,126	1

BRINKO[®]
powered by haupa

INFO

DIAMOND core drills „BRIdiamondDrill“

Advantages of the DIAMOND drills:

1

Sizes **6 - 8 - 10 mm** are able to drill **up to 30 holes** on tiles; **12 - 14 - 16 mm = up to 35 holes; above 20mm is up to about 40 holes** or more. The numbers will vary based on material thickness and machine speed.

2

Wax is for cooling temperature.

They usually use heat-resistant, non-easy melting wax to protect the diamond.

No extra cooling required single hole drilling - only required if multiple holes are drilled.

3

Our diamond is **HSD90, GRIT = 30/40 + 40/50, HRC=100** with the highest toughness and thermal toughness to be used for professional level of tools.

4

Machine speed RPM suggestions are:

Art. 1379-3 Series (with hex adapter)
= 1,000 - 2,500 RPM

Art. 1381-1 Series (with M14 thread)
= 10,000 - 14,000 RPM

1381-1 DIAMOND core drills “BRIdiamondDrill”

- **drilling without a centring aid**
- connector M14 to be used with the angle grinder
- hi-grade diamond grains for fast working, provide clean results
- perfectly suited for drilling clean holes in granite and stone slabs, porcelain, ceramics and tiles
- extremely long service life thanks to high speeds (recommended: 10,000 - 14,000 rpm),
- special wax filling ensures cooling, no extra cooling required single hole drilling - only required if multiple holes are drilled
- wax filled core helps cooling and lubricates, need not watering
- diamond coated design reduces cutting heat for 5X longer working life

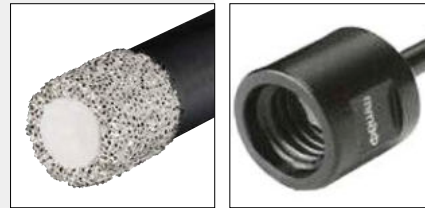

Art. no.	drill Ø	shaft Ø	kg	PU
1381-1/6 *	6	14	0,044	1
1381-1/8 *	8	14	0,047	1
1381-1/10 *	10	14	0,054	1
1381-1/12	12	14	0,055	1
1381-1/14	14	14	0,062	1
1381-1/18	18	14	0,000	1
1381-1/20	20	14	0,000	1
1381-1/25	25	14	0,000	1
1381-1/32	32	14	0,000	1
1381-1/35	35	14	0,000	1
1381-1/40	40	14	0,000	1
1381-1/45	45	14	0,000	1
1381-1/55	55	14	0,000	1
1381-1/60	60	14	0,281	1
1381-1/68	68	14	0,339	1
1381-1/50	50	14	0,000	1
1381-1/75	75	14	0,000	1
1381-1/82	82	14	0,474	1
1381-1/110	110	14	0,000	1



BRIdiamondDrill

DIAMOND core drills

1381 DIAMOND core drills set "BRIdiamondDrill"

- drilling without a centring aid, 7-pieces: Ø 2 x 6, 2 x 8, 10, 12, 14 mm
- connector M14 to be used with the angle grinder
- hi-grade diamond grains for fast working, provide clean results
- perfectly suited for drilling clean holes in granite and stone slabs, porcelain, ceramics and tiles
- extremely long service life thanks to high speeds (recommended: 10,000 - 14,000 rpm)
- special wax filling ensures cooling, no extra cooling required single hole drilling - only required if multiple holes are drilled



Art. no.	set	drill Ø	kg	PU
1381	7	6 - 14	0,442	0

1381-7 DIAMOND core drills set "BRIdiamondDrill"

- drilling without a centring aid, 7-pieces: Ø 3 x 6, 3 x 8, 10 mm
- connector M14 to be used with the angle grinder
- hi-grade diamond grains for fast working, provide clean results
- perfectly suited for drilling clean holes in granite and stone slabs, porcelain, ceramics and tiles
- extremely long service life thanks to high speeds (recommended: 10,000 - 14,000 rpm)
- special wax filling ensures cooling, no extra cooling required single hole drilling - only required if multiple holes are drilled



Art. no.	set	drill Ø	kg	PU
1381-7	7	6 - 10	0,625	1

DIAMOND core drills

1381-6 DIAMOND core drills set "BRIdiamondDrill"

- drilling without a centring aid; 7-pieces: Ø 2 x 6, 8, 10, 12, 14 mm
- 1 Centering Guide stainless 5 - 40 mm
- connector M14 to be used with the angle grinder
- hi-grade diamond grains for fast working, provide clean results
- perfectly suited for drilling clean holes in granite and stone slabs, porcelain, ceramics and tiles
- extremely long service life thanks to high speeds (recommended: 10,000 - 14,000 rpm)
- special wax filling ensures cooling, no extra cooling required single hole drilling - only required if multiple holes are drilled



Art. no.	set	drill Ø	kg	PU
1381-6	7	6 - 14	0,836	1

1381-4 DIAMOND core drills set "BRIdiamondDrill"

- drilling without a centring aid; 4-pieces: Ø 2 x 6, 8, 10 mm
- connector M14 to be used with the angle grinder
- hi-grade diamond grains for fast working, provide clean results
- perfectly suited for drilling clean holes in granite and stone slabs, porcelain, ceramics and tiles
- extremely long service life thanks to high speeds (recommended: 10,000 - 14,000 rpm)
- special wax filling ensures cooling, no extra cooling required single hole drilling - only required if multiple holes are drilled

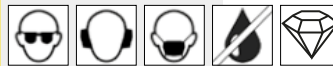

Art. no.	set	drill Ø	kg	PU
1381-4	4	6 - 10	0,257	1

DIAMOND core drills

1379-3 DIAMOND core drills "BRIdiamondDrill"

Advantages of the DIAMOND drills:

- precise positioning, minimum risk of slipping off
- Safety, Fast, Efficiency & Sophisticated design
- special wax filling ensures cooling, no extra cooling required single hole drilling - only required if multiple holes are drilled

Reliable cutting, drilling & grinding in the following materials:

floor and wall tiles, hard porcelain, granite and marble, glass and fiberglass

- hex shank 8 mm ideal for Akkus drills
- wax filled core helps cooling and lubricates, need not watering
- a strong bond is made through the brazing process extending service life
- Diamond coated design reduces cutting heat for 5X longer working life

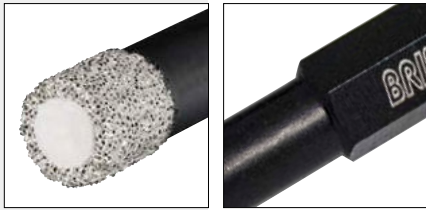
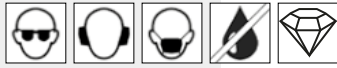

Art. no.	l	drill Ø	kg	PU
1379-3/5	67	5	0,012	1
1379-3/6 *	67	6	0,013	1
1379-3/8 *	80	8	0,018	1
1379-3/10 *	80	10	0,027	1
1379-3/12	80	12	0,034	1

1379-4 DIAMOND core drills set "BRIdiamondDrill"

- drilling without a centring aid; 4-pieces: Ø 2 x 6, 8, 10 mm
- hi-grade diamond grains for fast working, provide clean results
- perfectly suited for drilling clean holes in granite and stone slabs, porcelain, ceramics and tiles
- extremely long service life thanks to high speeds (recommended)
- special wax filling ensures cooling, no extra cooling required single hole drilling - only required if multiple holes are drilled



Art. no.	set	drill Ø	kg	PU
1379-4	4	2 - 10	0,117	1

1385-6 Centering Guide stainless "BRIdiamondDrill"

Stainless steel Centering guide for diamond core drills

Suitable for Diamond tools with a diameter of 5 - 40 mm

Features:

- with strong suction bell
- infinitely adjustable
- easy fixing
- professional stainless steel model
- extreme handy

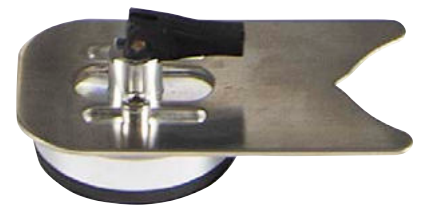

Art. no.	kg	PU
1385-6	0,000	1

BRINKO[®]
powered by **haupa**

DIAMOND core drills

1379-6 DIAMOND core drills set "BRIdiamondDrill"

- drilling without a centring aid; 7-pieces: Ø 2 x 6, 8, 10, 12, 14 mm
- 1 Centering Guide stainless 5 - 40 mm
- hex shank Ø 8 mm
- hi-grade diamond grains for fast working, provide clean results
- perfectly suited for drilling clean holes in granite and stone slabs, porcelain, ceramics and tiles
- extremely long service life thanks to high speeds (recommended)
- special wax filling ensures cooling, no extra cooling required single hole drilling - only required if multiple holes are drilled



Art. no.	set	drill Ø	kg	PU
1379-6	7	2 - 14	0,658	1

1385-1 DIAMOND tile drill

- diamond encrusted, durable blades
- for pinpoint accuracy and sharp-edged bores in hard and valuable materials e.g. tiles, porcelain, ceramics, granite, marble

Not suitable for safety glass!

Suitable for cordless machines, without cooling wax!



Art. no.	drill Ø	kg	PU
1385-1/5	5	0,009	1
1385-1/6	6	0,010	1
1385-1/8	8	0,011	1
1385-1/10	10	0,011	1
1385-1/12	12	0,013	1
1385-1/14	14	0,015	1

1386 DIAMOND Core bit

- SDS-plus chuck adaptor
- internal thread M16
- diamond-encrusted cutting
- drilling depth 55 mm
- centring drill bit
- drift punch
- safe drilling for switches and sockets in concrete and stone walls
- not suitable for hammer drilling
- Spare parts on request.



Art. no.	drill Ø	kg	PU
1386/68	68	0,625	1
1386/82	82	0,820	1

Sheet metal punch and drill

912 Sheet metal punch

- with 3 blades
- for punching sheet metal made of Nirosta, aluminium, copper, brass, iron etc. as well as plastics



Art. no.	Ø	kg	PU
912/15	15	0,100	1
912/16	16	0,102	1
912/17	17	0,102	1
912/18	18	0,104	1
912/19	19	0,104	1
912/20	20	0,115	1
912/21	21	0,128	1
912/22	22	0,138	1
912/23	23	0,136	1
912/24	24	0,145	1
912/25	25	0,153	1
912/26	26	0,153	1
912/27	27	0,165	1
912/28	28	0,173	1
912/30	30	0,193	1
912/31	31	0,193	1
912/33	33	0,218	1
912/34	34	0,235	1
912/36	36	0,317	1
912/38	38	0,311	1
912/39	39	0,311	1
912/40	40	0,373	1
912/41	41	0,373	1
912/42	42	0,415	1
912/43	43	0,420	1
912/44	44	0,476	1
912/45	45	0,598	1
912/46	46	0,598	1
912/48	48	0,601	1
912/49	49	0,620	1
912/50	50	0,650	1
912/51	51	0,678	1
912/52	52	0,699	1
912/53	53	0,707	1
912/55	55	0,725	1

910 Sheet metal punch | Plumbing

- for sanitary installations
- with 3 blades
- for punching sheet metal made of Nirosta, aluminium, copper, brass, iron etc. as well as plastics



Art. no.	Ø	kg	PU
910/11/8	28,5	0,192	1
910/11/4	31,7	0,249	1

900 Sheet metal punch | Electric

- for electric installations
- with 3 cutters
- for punching sheet metal made of Nirosta, aluminium, copper, brass, iron, etc. as well as plastics



Art. no.	Ø	Nominal size PG	kg	PU
900/9	15,2	9	0,096	1
900/11	18,6	11	0,150	1
900/13,5	20,4	13,5	0,126	1
900/16	22,5	16	0,128	1
900/21	28,3	21	0,122	1
900/29	37	P9	0,189	1
900/36	47	36	0,587	1
900/42	53,9	42	0,682	1
900/48	60	48	0,959	1

Sheet metal punch and drill

905 Sheet metal punch | Electric

- for electric installations
- for electric grommets
- with 3 cutters
- for punching sheet metal made of Nirosa, aluminium, copper, brass, iron, etc. as well as plastics



Art. no.	Ø	kg	PU
905/16,5	16,5	0,112	1
905/20,5	20,5	0,117	1
905/25,5	25,5	0,120	1
905/32,5	32,5	0,217	1
905/40,5	40,5	0,372	1
905/50,5	50,5	0,626	1
905/63,5	63,5	0,753	1

913 Replacement screw

Suitable for sheet metal punches:

- thread 8 x 1 mm, length 35 mm
- thread 10 x 1 mm, length 55 mm
- thread 12 x 1,5 mm, length 70 mm
- thread 16 x 1,5 mm, length 80 mm



Art. no.	Loch Ø	kg	PU
913/8x1	8	0,021	1
913/10x1	10	0,041	1
913/12x1,5	12	0,067	1
913/16x1,5	16	0,151	1

Art. no.	for Art. 900	for Art. 905	for Art. 910	for Art. 912
913/8x1	PG 9			Ø 15 mm
913/10x1	PG 11,5 - 29	Ø 16,5 - 32,5 mm	1 1/8" + 1 1/4"	Ø 16 - 34 mm
913/12x1,5	PG 36	Ø 40,5 mm		Ø 36 - 50 mm
913/16x1,5	PG 42 - 48	Ø 50,5 - 63,5 mm		Ø 51 - 55 mm

1085 Screw remover

- Chrome vanadium steel

Art. no.	tip Ø	shank Ø	screws
1085/1	1.75 mm	3.97 mm	M 3-6
1085/2	2.2 mm	4.76 mm	M 6-8
1085/3	3.3 mm	6.35 mm	M 8-11



Art. No.	size	→→→	twist drill Ø	kg	PU
1085/1	1	50,8	2,5	0,003	10
1085/2	2	60,3	3,0	0,006	10
1085/3	2	68,3	4,5	0,012	10

1086 Screw remover set

- Chrome vanadium steel
- supplied in a plastic box



Art. no.	set	size	kg	PU
1086/1-5	5	1 - 5	0,107	1
1086/1-6	6	1 - 6	0,224	1
1086/1-8	8	1 - 8	0,723	1

Hole saws

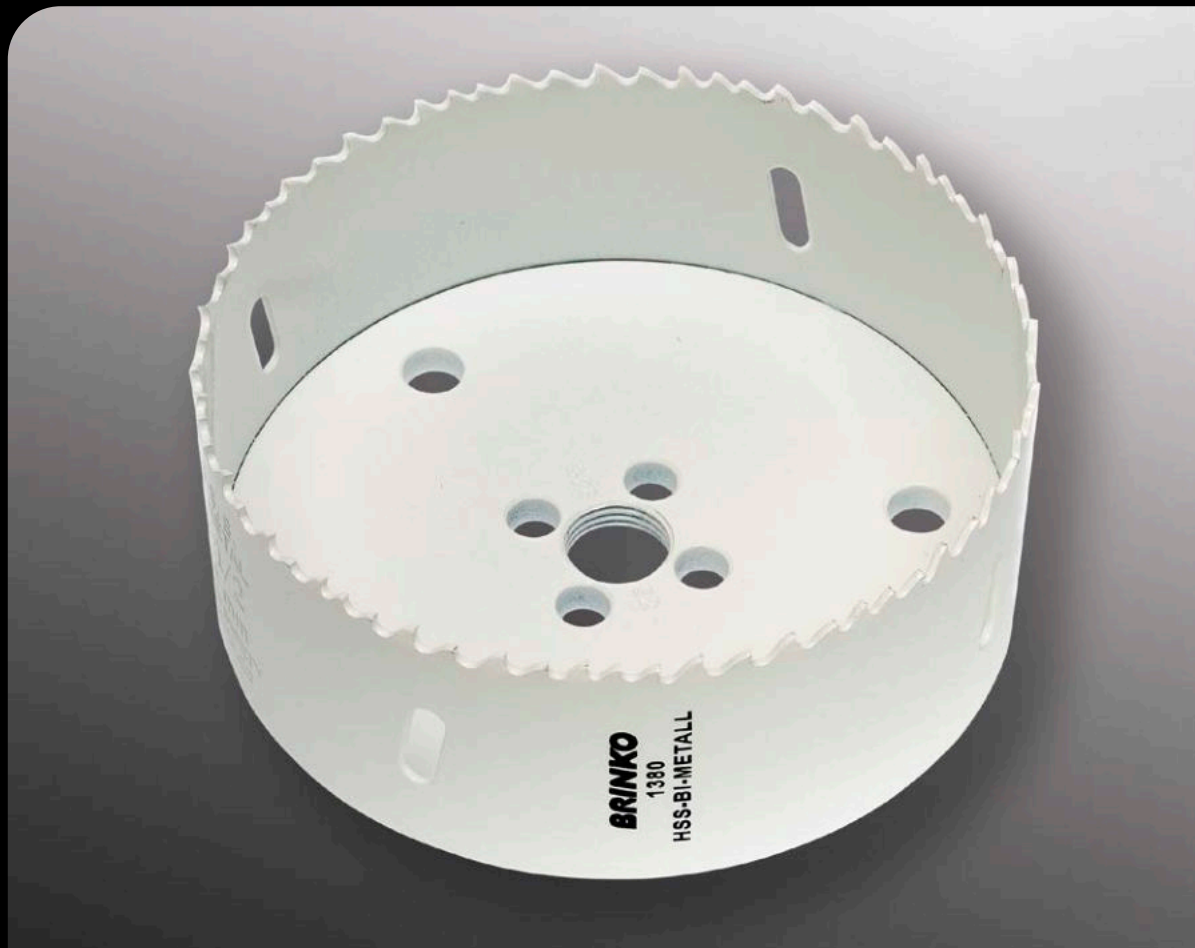

Hole Saws

1384 HSS-bi-metal hole saw set | Plumbing standard

For sanitary work

- supplied in unbreakable plastic case, 6 pieces:
- 5 HSS-bi-metal hole saws Ø 44, 57, 68, 75, 114 mm, 4 - 6 tpi
- 1 SDS chuck adaptor with HSS drill
- cutting depth 40 mm
- for steel, Nirosta, non-ferrous metals, HAT pipe, wood and aerated concrete
- also ideal for switches and sockets
- all hole saws are also available individually Art. no. 1380



Art. no.	set	kg	PU
1384 *	6	3,665	1

1380 HSS-bi-metal hole saw

- with variable teething, 4 - 6 tpi
- cutting depth 40 mm
- for steel, Nirosta, non-ferrous metals, HAT pipe, wood and aerated concrete
- other sizes available on request



Art. no.	Ø	kg	PU
1380/22	22	0,054	1
1380/25	25	0,052	1
1380/29	29	0,084	1
1380/32	32	0,085	1
1380/35	35	0,099	1
1380/38	38	0,093	1
1380/44 *	44	0,112	1
1380/51	51	0,117	1
1380/57 *	57	0,146	1
1380/64	64	0,148	1
1380/68 *	68	0,198	1
1380/75	75	0,239	1
1380/114 *	114	0,415	1
1380/121	121	0,538	1

1382 HSS-bi-metal hole saw set | Electro

For electrical work

- Supplied in unbreakable plastic case, 8 pieces:
- 6 HSS-bi-metal hole saws Ø 22, 29, 35, 44, 51, 64 mm, 4 - 6 tpi
- 1 SDS chuck adaptor with HSS drill 14 - 30 mm
- 1 SDS chuck adaptor with HSS drill 32 - 152 mm
- cutting depth 40 mm
- for steel, Nirosta, non-ferrous metals, HAT pipe, wood and aerated concrete



Art. no.	set	kg	PU
1382	8	0,933	1

1380-1 HSS guide drill, SDS-Plus

- suitable for SDS chuck adaptor Art. no. 1380-2 and hexagonal chuck adaptor Art. no. 1380-3



Art. no.	Ø	chuck adapto	kg	PU
1380-1/70	70	SDS-Plus	0,014	1
1380-1/105	105	hexagonal	0,020	1

Hole Saws

1380-2 SDS chuck adaptor with drill

- with HSS guide drill
- suitable for hole saws Art. no. 1380
- spare part for hole saw set Art. no. 1382 and 1384



Art. no.	Ø	kg	PU
1380-2/1	14 - 30	0,086	1
1380-2/2	32 - 152	0,240	1

1380-3 Hexagonal chuck with drill

- with HSS guide drill
- suitable for hole saws Art. no. 1380
- spare part for hole saw set Art. no. 1382 and 1384



Art. no.	Ø	kg	PU
1380-3/1	14 - 30	0,077	1
1380-3/2	32 - 152	0,190	1

1771 Cutting oil spray

- **DVGW certified**
- provides optimal lubrication when cutting & drilling
- cooling lubricant for drinking water installations and other applications
- free of mineral oil, fully synthetic, completely water soluble
- excellent lubrication properties for all cutting and drilling work
- can be used undiluted with all commercially available thread cutting machines
- even at high cutting speeds



Art. no.	Content ml	kg	VE
1771	400	0,534	1

1377 Tile kit

Tile kit - „the gap filler“

- for repairing surface and edge damage to tiles as well as to natural and artificial stone
- without needing any drying or hardening time at all
- Result remains stable up to 130 °C!

melt filler, work it in,
scrape off excess,
Seal with clear lacquer - finished!

Supplied in a strong plastic case:

- 1 filler spatula, transparent
- 2 clear lacquers, matt and shiny
- 1 grinding and polishing cloth
- 1 sandpaper
- 1 sanding cork, small
- 1 battery melter
- 20 various colours
- 1 hard wax, transparent
- 1 small bottle of NC-thinner



melt filler, work it in



scrape off excess



Seal with clear lacquer - finished!



Art. no.	set	kg	PU
1377	29	0,939	1

BRINKO
powered by **haupa**

Saws and Saw blades

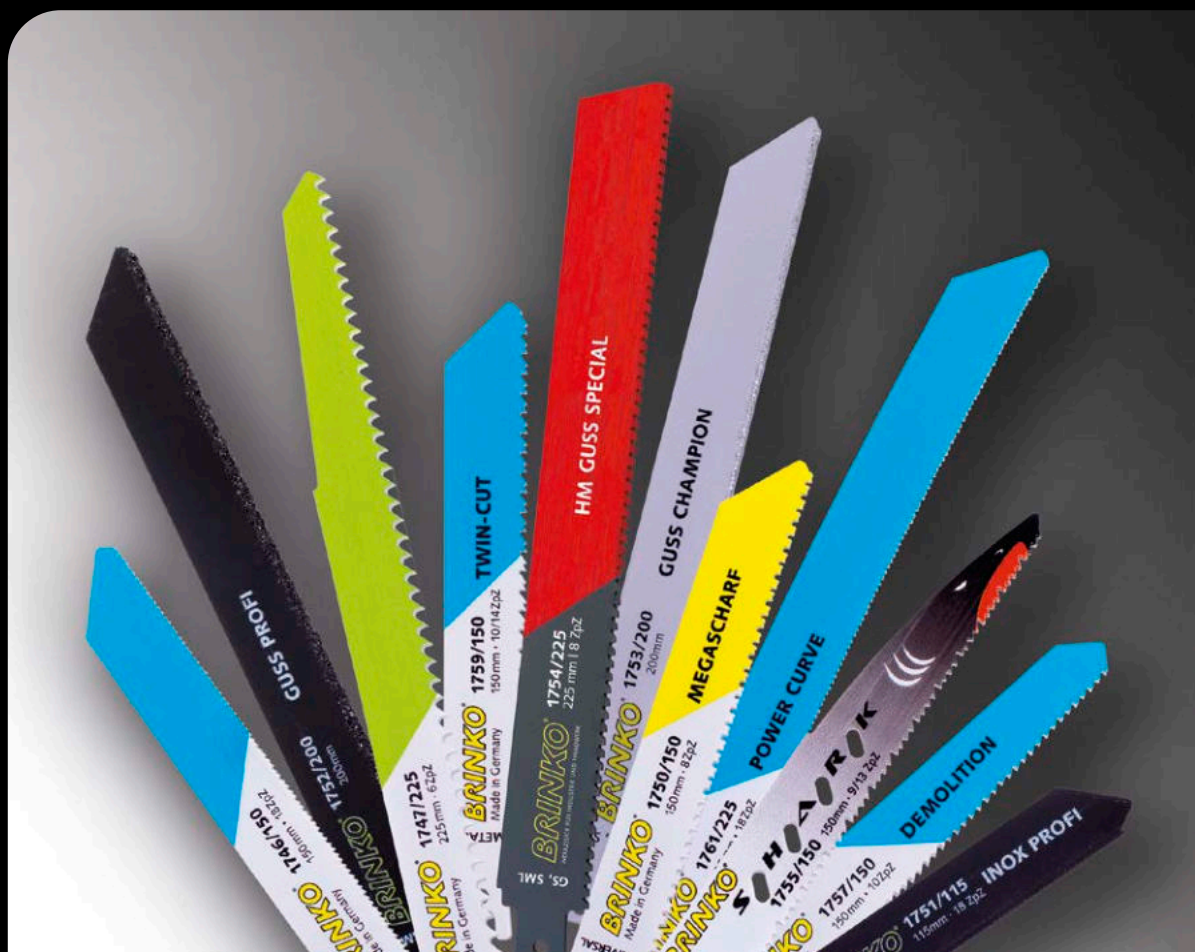

Hole Saws

1724/300 Metal saw bow

- strong design
- powder-coated
- with quick dowel pin
- material thickness 18 x 8 mm
- span width 300 mm
- suitable saw blades Art. no. 1738, 1739, 1740



Art. no.	Sbl.	kg	PU
1724/300	300	0,750	2

1729/146 Universal bow saw | fold-down

- with all-purpose saw blade
- fold-down wooden handle
- span width 146 mm



Art. no.	Sbl.	kg	PU
1729/146	146	0,133	6

1726/146 Universal bow saw

- with all-purpose saw blade
- fibreglass reinforced plastic handle
- the extremely angled bow makes it easier to work in places that are difficult to access
- span width 146 mm



Art. no.	Sbl.	kg	PU
1726/146	146	0,168	6

1728/146 Universal bow saw

- with all-purpose saw blade
- wooden handle
- span width 146 mm



Art. no.	Sbl.	kg	PU
1728/146	146	0,095	12

Hand saw blades

1730/146 Saw blade Universal

- for universal, precise sawing work
- blade length 150 mm | pin spacing 146 mm
- toothed part 24 tpi | 10/cm
- materials: metal, aluminium, nonferrous metals, all wood, plastic ducts -pipes, gypsum, etc.
- suitable for universal bow saws Art. no. 1726, 1728, 1729



Art. no.	↔	TPI	kg	PU
1730/146 *	150	24	0,002	144

1732/146 Saw blade Metal

- for high quality sawn edges
- blade length 150 mm | pin spacing 146 mm
- toothed part 32 tpi | 12/cm
- materials: all metals, nonferrous metals, stainless steel, special alloys, perspex, plastics
- suitable for universal bow saws Art. no. 1726, 1728, 1729



Art. no.	↔	TPI	kg	PU
1732/146	150	32	0,002	144

1731/146 Saw blade Wood

- for effortless sawing work in wood
- blade length 150 mm | pin spacing 146 mm
- toothed part 14 tpi | 5.5/cm
- materials: soft, hard and profile wood, fibreboard, garden wood, cardboard and soft plastics
- suitable for universal bow saws Art. no. 1726, 1728, 1729



Art. no.	↔	TPI	kg	PU
1731/146	150	14	0,029	144

1738/300 Metal cutting saw blade HSS

- HSS, flexible
- for plastics and metal
- length 300 mm | width 13 mm | thickness 0.63 mm
- toothed part 24 tpi
- suitable for metal saw bow Art. no. 1724



Art. no.	↔	TPI	kg	PU
1738/300	300	24	0,017	50

1739/300 Metal cutting saw blade HSS-Bi-metal

- HSS-Bi-metal, flexible
- length 300 mm | width 13 mm | thickness 0.63 mm
- toothed part 24 tpi
- suitable for metal saw bow Art. no. 1724



Art. no.	↔	TPI	kg	PU
1739/300 *	300	24	0,017	50

1740/300 Metal cutting saw blade

- spring steel (C 75)
- length 300 mm | width 25 mm | thickness 0.8 mm
- serrated on both sides 24 teeth for metal and 14 teeth for plastic
- suitable for metal saw bow Art. no. 1724



Art. no.	↔	TPI	kg	PU
1740/300 *	300	24 14	0,044	50

INFO

Sabre saw blades for all applications

BRINKO saw blades, made of European quality steel, and our experience leads to the best solutions for your project.

Depending on the material, whether hard materials (e.g. iron, stainless steel, hardwood, and tiles) or soft materials (e.g. softwoods, chipboard, and plastics) and the desired cutting quality, you will find the right saw blade at BRINKO.

The fine-toothed saw blades for cuts of thin/thin-walled materials ensure a clean, tear-free cut with little damage to the material. With our coarse-toothed saw blades for cutting in large dimensions, you can achieve a fast and rough cut in plastics, wood, and metals.

In addition, the different toothing of the saw blade is decisive for the desired cutting structure. Additional cooling (cutting oil article 1771 for steel and metal, water for plastics) increases the service life and wear resistance of the saw blades.

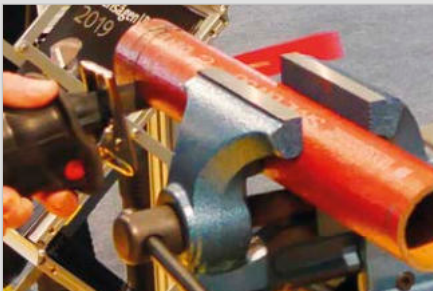

INFO

Choice of saw blade, Cutting quality

THE RIGHT CHOICE OF SAW BLADE

Our new reciprocating saw blade and packaging design guarantees a quick and correct saw blade selection for the material to be cut. Dwal, specific reciprocating saw blades are used and an optimal sawing result is guaranteed.

Teeth Per Inch (TPI)

Determine the cutting quality and cutting speed.

Suitable for all recipro, sabre and tiger jigsaws:

AEG, Black&Decker, Bosch, DeWALT, Fein, Flex, HILTI, Hitachi, Makita, Metabo, Milwaukee, Porter Cable, Rems, Roller, WÜRTH etc.

Blade length

Rule of thumb

Always keep 2 – 3 teeth cutting in the material
Material width + 50 mm = Blade length

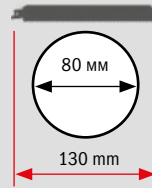

Example 1
80 mm Tube + 50 mm = 130 mm

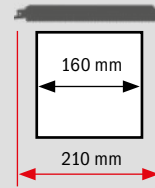

Example 2
160 mm Beam + 50 mm = 210 mm

FEE TEETH COARSE CUT		CUTTING QUALITY					MANY TEETH CLEAN CUT		
FAST		CUTTING SPEED					SLOW		
6 TPI	8 TPI	9/13 TPI	10 TPI	10/14 TPI	14 TPI	18 TPI	GRIT		
Art. nr. 1747	1750 1754	1755	1757 1745	1759	1745 1762	1746 1761 1751	1752 1753		
225	150 225	150	150 300	150	150 150	100 150 115	200 200		
Length (mm)	200 280		225 300	225 280	200 225	150 225			

INFO

Kind of tothing, cutting performance

The tothing type and the tooth geometry determine the cutting result.

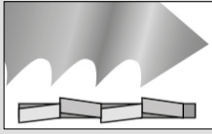

Side set tothing;
rough cuts

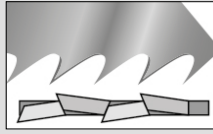

Side set, diagonally
sharpened tothing;
rough, quick cuts.

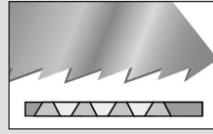

Conically ground blade,
teeth diagonally sharpe-
ned tothing; precise,
clean cuts

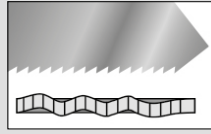

Wavy set tothing; fine
and clean cuts

Sabre saw blade	Art. No.	Length mm	Recommendation	Teeth Per Inch (TPI)
INOX Profi	 1751/115	115	without stroke action	 18
Metal	1745/150 *	150	without stroke action	14
	1745/200 *	200		14
	1745/300 *	300		10
Metal	1746/100 *	100	without stroke action	14
	1746/150 *	150		
Metal POWER CURPU	1761/150	150	without stroke action	 18
	1761/225	225		
Metal POWER CURPU	1762/150	150	without stroke action	 14
	1762/225	225		
Metal DEMOLITION	1757/150	150	without stroke action	 10
	1757/225	225		
	1757/300	300		
Metal TWIN-CUT	1759/150	150	with/without stroke action	10/14
	1759/225	225		
	1759/280	280		
Universal SHARK	 1755/150	150	without stroke action	9/13
Universal MEGASHARP	1750/150 *	150	with stroke action	8
	1750/200 *	200		
	1750/280	280		
HM CAST SPECIAL	 1754/225	225	without stroke action	 8
CAST CHAMPION 	 1753/200 *	200	without stroke action	 Grit
CAST PROFI	 1752/200 *	200	with/without stroke action	Grit
Wood	 1747/225	225	with stroke action	6

Application overview

Sabre saw blades with significantly longer life

The performance of a saw blade depends on the base material quality, the kind of toothing and the tooth geometry.

These factors guarantee in conjunction with the correct use of the machine and blade selection the optimum result in cutting all materials.

Stainless steel	Steelpipes, steelprofiles	Sheet metals	Non-ferrous metals	Aluminium	Cast steel pipes	Cast iron (SML)	Brick, Brickwork	Cement asbestos	Gypsum board	Ceramics	Fire & Rescue	Rubber	Plastics	Carbon-fibre reinforced products	Perspex	All types of wood	Wood with metal residues	Straight cut
■	■	■												■	■			
■	■		■															
■	■																	
■	■																	
■	■										■						■	■
	■		■	■													■	
	■		■														■	
	■		■										■				■	
■	■		■		■	■						■						
					■	■	■	■		■								
						■	■			■				■				
									■				■			■		■

■ Attention: Use bi-metal reciprocating saw blades with reduced speed and cooling when sawing stainless steel.

Sabre Saw Blades

1751/115 Sabre saw blade INOX Profi

Without stroke action

Special saw blade for sheets and profiles made of stainless steel, glass-fibre, CRP, GRP, epoxy and Perspex

- tungsten carbide strip with grinded teeth, 18 tpi
- toothed length 95 mm

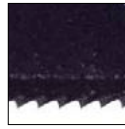
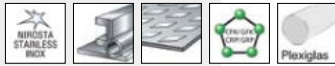

Art. no.	Length	TPI	kg	PU
1751/115	115	18	0,025	1

1745 Sabre saw blade Metal

Without stroke action

Topseller - Standard saw blade

for steel, stainless steels (INOX), profiles and non-ferrous metals from 3 to 12 mm

- HSS-Bi-metal
- teeth milled and wavy set

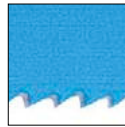

Art. no.	Length	TPI	kg	PU
1745/150 *	150	14	0,015	25
1745/200 *	200	14	0,022	25
1745/300 *	300	10	0,033	25

1746 Sabre saw blade Metal

Without stroke action

Topseller - Standard saw blade for steel and stainless steel (1.5 - 4.0 mm)

- HSS-bi-metal
- teethed part 18 tpi
- Teeth milled and wavy set

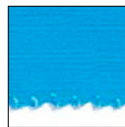

Art. no.	Length	TPI	kg	PU
1746/100 *	100	18	0,009	25
1746/150 *	150	18	0,016	25

1761 Sabre saw blades Metal POWER CURPU

Without stroke action

Flexible all-round blade for steel and stainless steel from 1.5 - 2.5 mm

- teeth milled and wavy set, 18 tpi
- the curved blade is more aggressive because more teeth can work in the material
- for faster cuts and longer lifetime

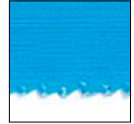

Art. no.	Length	TPI	kg	PU
1761/150	150	18	0,026	25
1761/225	225	18	0,039	25

1762 Sabre saw blades Metal POWER CURPU

Without stroke action

Flexible all-round blade for steel and stainless steel from 2,0 - 8,0 mm and non-ferrous metals

- teeth milled and wavy set, 14 tpi
- curved blade for faster cuts and longer lifetime
- flexible all-round blade for steel and stainless steel from 2 to 8 mm and non-ferrous metals



Art. no.	Length	TPI	kg	PU
1762/150	150	18	0,026	25
1762/225	225	18	0,039	25

1757 Sabre saw blades Metal DEMOLITION

Without stroke action

Especially for dismantling, rescue and salvage

Special thick and robust blade for fast and straight cuts in steel thicker than 3 mm and all types of wood with metal residues

- teeth milled and side set, 10 tpi

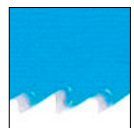

Art. no.	Length	TPI	kg	PU
1757/150	150	10	0,027	15
1757/225	225	10	0,061	15
1757/300	300	10	0,084	15

Sabre Saw Blades

1759 Sabre saw blades Metal TWIN-CUT

Without stroke action
but can also withstand pendulum strokes
With innovative Twin-Cut tooth geometry for better performance and longer lifetime

For steelpipes and -profiles thicker than 2.5 mm, non-ferrous metals, aluminum and wood with metal residues

- flexible bi-metal blade
- teeth milled and side set, flexible
- with innovative 10/14 tooth geometry for better performance and longer lifetime



Art. no.	l	TPI	kg	PU
1759/150	150	10	0,026	25 5
1759/225	225	10	0,040	25 5
1759/280	280	10	0,034	25 5

1755/150 Sabre saw blade Universal SHARK

Without stroke action
Considerably longer durability by a better heat dissipation due to the cooling slots

Universal applicable for steelpipes and -profiles, non-ferrous metals, wood with metal residues 2.0 – 10.0 mm

- teeth milled and side set
- with innovative 9/13 two-stage toothing



Art. no.	l	TPI	kg	PU
1755/150	150	9	0,024	25 5

1750 Sabre saw blades Universal MEGASHARP

Best results at highest machine speed with pendulum stroke
Universal blade, in particular for steel from 1.5 – 6 mm wall thickness

- HSS-bi-metal
- unique M-toothing for very quick and precise cuts and an above-average life



Art. no.	l	TPI	kg	PU
1750/150 *	150	8	0,020	25 5
1750/200 *	200	8	0,025	25 5
1750/280	280	8	0,035	25 5

1754/225 Sabre saw blade HM CAST SPECIAL

Without stroke action

Hard-metal toothing, Especially suitable for difficult-to-cut metals, e.g. cast steel pipes (black pipes), cast, iron (red SML), stainless steel, nonferrous, metals, construction steel, reinforcement, steel pipes, angle irons, rubber with steel mantle (< 175 mm)

- tooth pitch 3.2 mm | 8 tpi
- length 225 mm, toothed length 205 mm
- width 25 mm | material thickness 1.5 mm



Art. no.	l	TPI	kg	PU
1754/225	225	8	0,063	1 1

BRINKO[®]
powered by **haupa**

Sabre Saw Blades

1753/200 Sabre saw blade CAST CHAMPION

Without stroke action

Diamant carbide gritted. Special saw blade for cast steel-pipes, cast iron, brick, ceramics and glass-fibre reinforced products (GRP)

- diamond coating, clean and straight cut
- much quicker cut and longer service life than normally coated saw blades



Art. no.	Length (mm)	TPI	kg	PU	PU
1753/200 *	200		0,040	1	1

1752/200 Sabre saw blade CAST PROFI

With/without stroke action

With carbide granulate coating special for SML pipes (cast), glass, ceramics, GRP materials



Art. no.	Length (mm)	TPI	kg	PU	PU
1752/200 *	200		0,040	10	2

1747/225 Sabre saw blade Wood

With/without stroke action

Standard blade for wood, but now new cross-ground toothing For quick, straight cuts on all types of wood, plastic and drywall (6 - 100 mm)

- HCS/CV steel, teeth 6 tpi
- teeth milled and side set

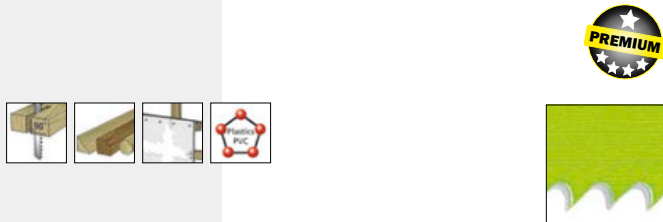

Art. no.	Length (mm)	TPI	kg	PU	PU
1747/225 *	225	6	0,031	20	5

1743 Sabre saw blades (U-shank)

For pipes, steel, stainless steel, nonferrous metals, cast iron, hard plastic

- HSS-Bi-metal, material strength 0.9 mm
- width 25 mm, teeth 10/14 tpi
- suitable for recipro sabre and tiger jigsaws made by Rems and Roller



Art. no.	Length (mm)	TPI	kg	PU	PU
1743/150	150	10/14	0,021	25	5
1743/200	200	10/14	0,032	25	5

1756/75 Jigsaw blade Wood

Fast cut in all wood types (5.0 - 50 mm)

Long lifetime

- HSS-Bi-metal
- side set and diagonally sharpened teeth
- tooth spacing 4 mm
- universal blade for all wood



Art. no.	Length (mm)	TPI	kg	PU	PU
1756/75	75		0,020	25	5

1758 Jigsaw blade Metal

Flexible blade for steel and stainless steel (1.2 - 3.0 mm)

Long lifetime

- HSS-Bi-metal
- teeth milled and wavy set
- tooth spacing 1.2 mm



Art. no.	Length (mm)	TPI	kg	PU	PU
1758/55	55		0,005	25	5
1758/105	105		0,010	25	5

Cutting



Knives

2980 Universal knife

“Das Original” BRINKO cutter knife

- ergonomic 2-component handle with soft plastic
- blade feed with automatic lock
- 2 replacement blade strips in the handle

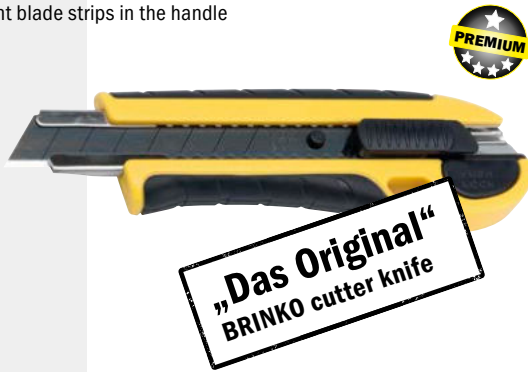

Art. no.	kg	PU
2980 *	0,103	6

2982 Blade dispenser „Black Blades“

“Original” BRINKO “Black Blades”

- 10 strips of „Black Blades“
- super-sharp, reinforced design
- width 18 mm, thickness 0.5 mm
- suitable for universal knife Art. no. 2980

10x



Art. no.	kg	PU
2982 *	0,081	20

3525 Cable knife

- Stainless steel blade
- with scraper and saw blade
- robust plastic handle, blue



Art. no.	kg	PU
3525	0,083	6

3526 Cable knife

- Stainless steel blade
- without scraper, with a set of teeth
- robust plastic handle, red



Art. no.	kg	PU
3526	0,057	6

2991 Universal knife

- made of pressure die-cast zinc
- ergonomic shape
- trapezoidal blade, blade can automatically be retracted
- blade replacement without tools (interlock system)
- blade depot for 5 blades



Art. no.	kg	PU
2991	0,170	6

2992 Blade dispenser trapezoidal

- 10 trapezoidal blades
- suitable for Universal knife Art. no. 2991

10x



Art. no.	kg	PU
2992	0,025	10

2993 Blade dispenser hook

- 10 hook blades
- suitable for universal knife Art. no. 2991

10x



Art. no.	kg	PU
2993	0,031	10

Shears

762/260 Ideal scissors

- Cast steel blade
- with spring and lock
- right-hand cutting
- for sheet steel up to 1.5 mm thick
- length 260 mm



Art. no.	kg	PU
762/260 *	0,581	1

786/260 Ideal scissors

- with a spring
- red dip insulated
- left-hand cutting
- for V2A sheet steel
- length 260 mm



Art. no.	kg	PU
786/260	0,609	3

792/250 Punching scissors

- with a spring
- red dip insulated
- right-hand cutting
- for V2A sheet steel
- length 250 mm



Art. no.	kg	PU
792/250	0,500	3

793/250 Punching scissors

- with a spring
- red dip insulated
- left-hand cutting
- for V2A sheet steel
- length 250 mm



Art. no.	kg	PU
793/250	0,514	3

794/250 Shaped punching scissors

- with a spring
- with particularly slim blades
- red dip insulated
- right-hand cutting
- for V2A sheet steel
- length 250 mm



Art. no.	kg	PU
794/250	0,470	3

798/300 Straight cutting scissors

- with a spring
- red dip insulated
- for V2A sheet steel
- length 300 mm



Art. no.	kg	PU
798/300	0,726	1

Cutting Discs

6200 Cut-off disk | Steel

- approved according to VBG 49
- for separating steel and other metals
- thickness 3.2 mm
- bore 22 mm



Art. no.	∅	kg	PU
6200/115 *	115	0,074	25
6200/125 *	125	0,087	25
6200/178	178	0,180	25
6200/230 *	230	0,305	25

6215 Cut-off disk | INOX

- certified according to VBG 49
- for cutting stainless steel, steel and other metals
- thickness 1.2 mm or 1.6 mm (with diameter 150 mm)
- bore 22 mm



Art. no.	∅	kg	PU
6215/115 *	115	0,025	25
6215/125 *	125	0,030	25
6215/150 *	150	0,030	50
6215/230 *	230	0,200	50

6219/125 Diamond cutting and chamfering disc

- Diamond coating
- long service life
- for cutting and chamfering all plastic pipes in one work process
- particularly suitable for all plastic drain pipes, e.g. KG, HT
- ∅ 125 mm



Art. no.	∅	kg	PU
6219/125	125	0,400	1

6240 Diamond cutting disc

- certified according to VBG 49
- sintered
- universal use for wet and dry cutting of almost all materials
- segment height 8 mm
- cut thickness 2 mm
- bore 22 mm



Art. no.	∅	kg	PU
6240/115 *	115	0,112	1
6240/125 *	125	0,142	1
6240/180	180	0,364	1
6240/230	230	0,637	1

Brushes and Files

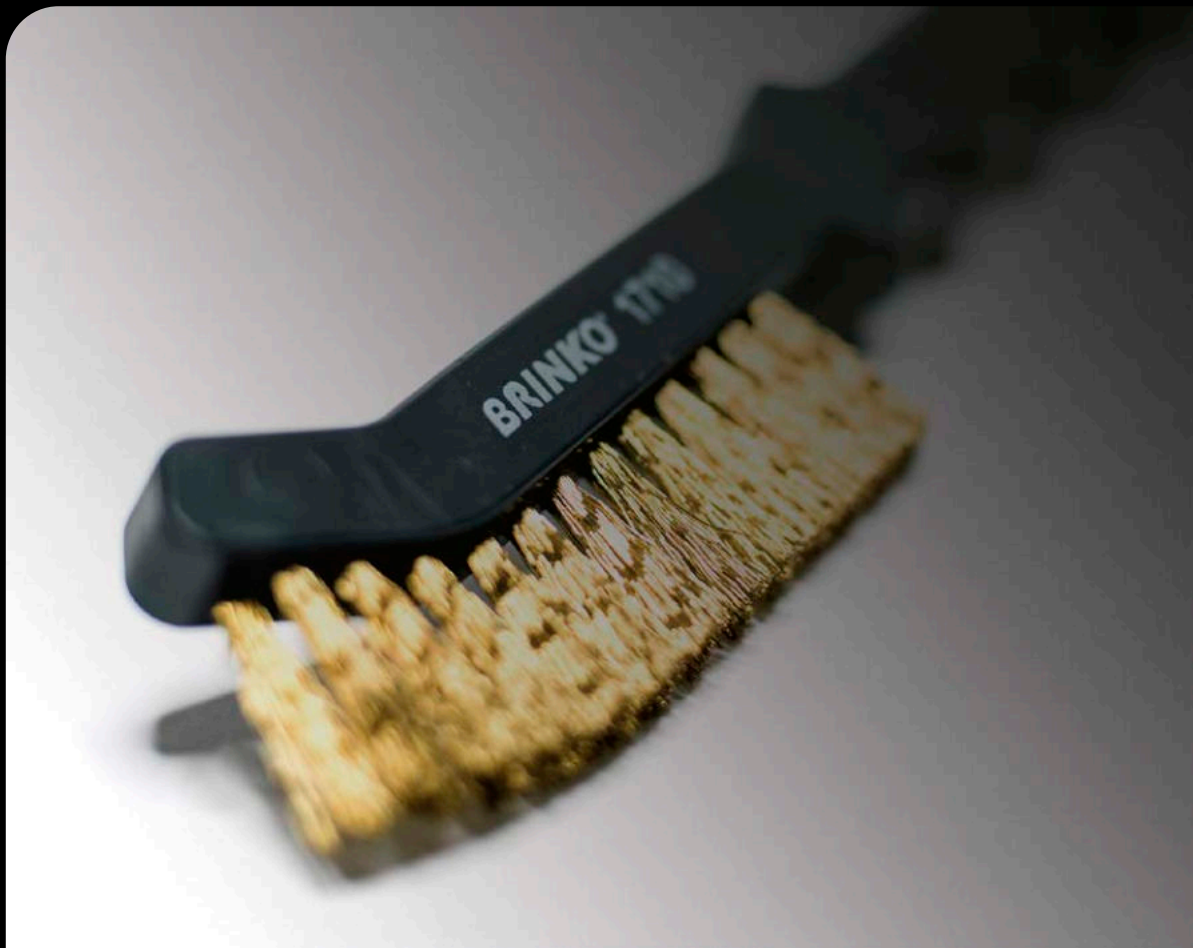

Brushes

1708 Wire brush

- fitted with steel wires
- beechwood body with hanging hole



Art. no.	rows	kg	VE
1708/3	3	0,103	12
1708/4 *	4	0,151	12
1708/5	5	0,145	12

1708-1 Wire brush

- fitted with brass wires
- beechwood body with hanging hole



Art. no.	rows	kg	VE
1708-1/3	3	0,116	12
1708-1/4	4	0,137	12

1709-1/80 Burner brush

- fitted with wavy brass wires
- wooden body
- total length 200 mm
- brush surface 80 x 15 mm
- in two rows



Art. Nr.	rows	kg	VE
1709-1/80 *	2	0,027	12

1710 Burner brush

- fitted with wavy brass wires
- with plastic handle
- total length 225 mm
- rows 2 x 13



Art. no.	rows	kg	VE
1710	2 x 13	0,130	10

1706 Fitting brush

- with a wooden handle
- for cleaning the inside of pipe ends



Art. no.	for pipes Ø	kg	PU
1706/12	12 mm, 3/8"	0,027	6
1706/15 *	15 mm, 1/2"	0,025	6
1706/18	18 mm, 5/8"	0,027	6
1706/22	22 mm, 3/4"	0,028	6
1706/28	28 mm, 1"	0,038	6

1706-1 Fitting brush

- with a wooden handle
- for cleaning the inside of pipe ends



Art. no.	for pipes Ø	kg	PU
1706-1/15	15 mm, 1/2"	0,055	6
1706-1/18	18 mm, 5/8"	0,055	6
1706-1/22	22 mm, 3/4"	0,060	6

1705 Fitting brush

- strong plastic body
- for cleaning the outside of copper pipe ends



Art. no.	for pipes Ø	kg	PU
1705/12	12 mm, 3/8"	0,021	6
1705/15	15 mm, 1/2"	0,026	6
1705/18	18 mm, 5/8"	0,034	6
1705/22	22 mm, 3/4"	0,032	6
1705/28	28 mm, 1"	0,040	6

1709/40x20 Brass brush

- fitted with thin, wavy brass wires
- wooden body
- total length 175 mm
- brush surface 40 x 20 mm
- in three rows



Art. no.	rows	kg	VE
1709/40x20 *	3	0,023	12

1654-1/250 Engineer's file half round

- half round file with plastic handle
- grade of cut 2: semi-fine, cut number 10 - 25
- cut length 250 mm
- thickness 7 mm



Art. no.	BL	kg	PU
1654-1/250	250	0,290	3

1655-1/250 Engineer's file flat

- flat file with plastic handle
- grade of cut 2: semi-fine, cut number 10 - 25
- cut length 250 mm
- thickness 6.3 mm



Art. no.	BL	kg	PU
1655-1/250	250	0,339	3

1653-1/250 Engineer's file round

- Round file with plastic handle
- grade of cut 2: semi-fine, cut number 10 - 25
- cut length 250 mm
- thickness 10 mm



Art. no.	BL	kg	PU
1653-1/250	250	0,165	3

1666-1/250 Wood rasp

- with plastic handle
- grade of cut 2: semi-fine, cut number 10 - 25
- cut length 250 mm
- width 23.8 mm
- thickness 7 mm



Art. no.	BL	kg	PU
1666-1/250	250	0,247	3

1658-1/250 Installation rasp

- flat rasp with plastic handle
- milled cut
- cut length 250 mm



Art. no.	BL	kg	PU
1658-1/250	250	0,262	3

1664/200 File rasp

- with polished wooden handle
- cut length 200 mm



Art. no.	BL	kg	PU
1664/200	200	0,170	3

Hammers and Chisels



Brushes

1409 Club hammer

High work safety:

- hickory handle with protection
- ring wedged and cast plastic



Art. no.	↔	kg	PU
1409/1000	260	1,128	2
1409/1250	260	1,388	2
1409/1500	280	1,650	2

1470 Cross peen hammer

High work safety:

- hickory handle with protection
- ring wedged and cast plastic



Art. no.	↔	kg	PU
1470/300	300	0,373	2
1470/500	320	0,601	2

231 Aluminium support brackets

- suitable for vices



Art. no.	Width	kg	PU
231/135	135	0,158	1
231/150	150	0,183	1

Chisels

2174/26 Chisel

- Chrome vanadium steel
- painted hornbeam handle
- slot width 26 mm



Art. no.	SW	kg	PU
2174/26	26	0,203	6

1325 Stone chisels

- air hardening chrome-vanadium-steel
- accident insured tool head



Art. no.	↔	SW	thickness	kg	PU
1325/250	250	28	20 x 12	0,386	3
1325/300	300	30	23 x 13	0,588	3
1325/350	350	32	23 x 13	0,699	3
1325/400	400	32	23 x 13	0,811	3

1332 Sitting chisels

- air hardening chrome-vanadium-steel
- accident insured tool head
- thickness 18 mm



Art. no.	↔	SW	thickness	kg	PU
1332/230	230	30	18	0,356	3
1332/300	300	30	18	0,476	3

1333/200x10 Electricians' chisels

- air hardening chrome-vanadium-steel
- accident insured tool head



Art. no.	↔	SW	thickness	kg	PU
1333/200x10	200	10	8	0,092	6

Chisels

1340/250 Sharp chisel SDS-Plus

- for electric hammers
- entire length 250 mm



Art. no.	length	kg	PU
1340/250	250	0,171	1

1341/250 Flat chisel SDS Plus

- for electric hammers
- entire length 250 mm
- slot width 20 mm



Art. no.	length	SW	kg	PU
1341/250 *	250	20	0,253	1

1342/200 Spade chisel SDS Plus

- for electric hammers
- entire length 250 mm
- slot width 40 mm



Art. no.	length	SW	kg	PU
1342/200 *	200	40	0,264	1

1391/6 Nail setter

- Chrome vanadium steel, air hardened finish
- octagonal
- with accident-proof impact head
- length 6 mm



Art. no.	length	kg	PU
1391/6	6	60,162	12

1315 Pointed punch

- chrome vanadium steel, air hardened finish
- octagonal
- with accident-proof impact head
- length 120 mm



Art. no.	length	thickness	kg	PU
1315/120-10	120	10	0,062	6
1315/120-12	120	12	0,089	6

Measuring and Marking



2513 DRY Profi

Effective pressing mechanism for automatic lead propulsion in robust stainless steel tube

- easy one-handed operation thanks to improved clip
- integrated sharpener with guide – for fast sharpening at any time
- Leads can be replenished from the front or back
- for all surfaces (wood, metal, glass, ceramics ...)
- special graphite lead included can be wiped off smooth surfaces with a damp cloth
- separately available coloured leads, water soluble or waterproof. Available in colour sets or individual colours for versatile use on light and dark backgrounds



Art. no.	kg	PU
2513	0,018	10

2514 DRY Profi LED

Integrated LED lamp for precise markings in poorly-lit areas

- immediately ready to use thanks to already included batteries, 3 x 1.5 V – LR 41 replaceable batteries
- easy-to-use pushbutton ideally placed in the grip area of the marker
- effective pressing mechanism for automatic lead propulsion in robust stainless steel tube
- easy single-handed operation thanks to improved clip
- integrated sharpener with guide for fast sharpening at any time
- Leads can be replenished from the front or back
- for all surfaces (wood, metal, glass, ceramics ...)
- special graphite lead included can be wiped off smooth surfaces with a damp cloth
- separately available coloured leads, water-soluble or waterproof Available in colour sets or individual colours for versatile use on light and dark backgrounds



Art. no.	kg	PU
2514	0,029	1

2511 DRY construction marker

- for all surfaces (plastic, glass, ceramic, metal, wood, ...)
- in a practical quiver with clip
- can be wet-wiped off smooth surfaces
- with a graphite-lead, improved feed and easy to change
- integrated tip, ideal single hand operation



Art. no.	kg	PU
2511	0,028	10

2511-1 DRY leads | Graphite

- 12x graphite 2B
- can be wet-wiped off smooth surfaces



Art. no.	quantity	kg	PU
2511-1	12	0,029	10

2511-2 DRY leads | Basic

- 6x graphite 2B, 3x red, 3x yellow
- can be wet-wiped off smooth surfaces
- Protect leads in red and yellow from high temperatures!



Art. no.	quantity	kg	PU
2511-2	12	0,028	10

Pencils & Marker

2511-3 DRY leads | Special

- 4x white, 4x green, 4x blue
- all leads are resistant to water jets
- ideal for wet-cutting tiles and stone

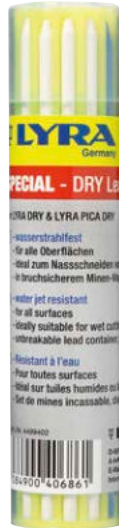

Art. no.	quantity	kg	PU
2511-3	12	0,026	10

2515/1 INK deep hole marker black

- for all surfaces (plastic, glass, ceramic, metal, wood, ...)
- in a practical quiver with a clip
- more precise marking in boreholes and in places which are difficult to access



Art. no.	kg	PU
2515/1	0,019	10

2515/2 INK deep hole marker red

- for all surfaces (plastic, glass, ceramic, metal, wood, ...)
- in a practical quiver with a clip
- more precise marking in boreholes and in places which are difficult to access



Art. no.	kg	PU
2515/2	0,019	10

2515/3 INK deep hole marker blue

- for all surfaces (plastic, glass, ceramic, metal, wood, ...)
- in a practical quiver with a clip
- more precise marking in boreholes and in places which are difficult to access



Art. no.	kg	PU
2515/3	0,019	10

2524/235 All-purpose pencil

- with special graphite lead, length 235 mm
- suitable for marking almost any material e.g. paper, glass, plastic, acrylic, wood, metal, ceramic, rubber and others - weather-proof
- also writes on greasy or damp surfaces



Art. no.	length	kg	PU
2524/235	235	0,014	12

2523/240 Carpenter's pencil

- oval
- unsharpened
- painted yellow
- length 240 mm



Art. no.	length	kg	PU
2523/240	240	0,012	12

2522 Sharpener

- made of plastic
- suitable for all carpenter's pencils Art. no. 2523 and all-purpose pencils Art. no. 2524



Art. no.	kg	PU
2522	0,010	12

BRINKO[®]
powered by **haupa**

Pencils & Marker

2525 Marking chalk red

- for marking wood, stone, concrete, steel
- length 120 mm
- Ø 12 mm



Art. no.	length	kg	PU
2525	120	0,010	12

2525-1 Marking chalk yellow

- for marking wood, stone, concrete, steel
- length 120 mm
- Ø 12 mm



Art. no.	length	kg	PU
2525-1	120	0,010	12

2525-2 Marking chalk blue

- for marking wood, stone, concrete, steel
- length 120 mm
- Ø 12 mm



Art. no.	length	kg	PU
2525-2	120	0,010	12

3552 Set of numbers

- Normal quality
- to be hammered into steel and iron



Art. no.	number height	set	kg	PU
3552/3	3	9	0,266	1
3552/4	4	9	0,320	1
3552/6	6	9	0,555	1
3552/8	8	9	0,869	1

3562/6 Letter set

- Normal quality, capital letters
- to be hammered into steel and iron
- letter height 6 mm
- steel thickness 10 mm, stamp length 75 mm



Art. no.	number height	set	kg	PU
3562/6	6	27	1,615	1

2836 Lightweight metal spirit level

- smooth rectangular profile, painted red
- perspex bubble tubes, leak-proof and unbreakable
- measurement surface on both sides, scale in mm and cm
- suitable for making overhead measurements
- with shock-absorbing and removable end caps, with nonslip pimples
- measurement accuracy: $0.0285^\circ = 0.5 \text{ mm per } 1 \text{ m}$ in normal position



Art. no.	↔	kg	PU
2836/300	300	0,180	2
2836/400	400	0,267	2
2836/600	600	0,378	2
2836/800	800	0,505	2
2836/1000	1000	0,646	2

2839 Spirit level

- spirit level made of ABS, painted blue
- integrated magnetic strip at the bottom
- with hanging hole
- perspex bubble tubes, leak-proof and unbreakable
- sticks on most metal surfaces



Art. No.	↔	width	kg	PU
2839	230	38	0,073	1

2836-1 Magnetic spirit level

- smooth rectangular profile, painted silver
- perspex bubble tubes, leak-proof and unbreakable
- with coated measurement surface, scale in mm and cm
- suitable for making overhead measurements
- with extra strong magnets for a secure hold on pipes, metal in inside walls, installations and other steel components
- with shock-absorbing and removable end caps, with nonslip pimples
- measurement accuracy: $0.0285^\circ = 0.5 \text{ mm per } 1 \text{ m}$ in normal position



Art. no.	↔	kg	PU
2836-1/400	400	0,299	2
2836-1/600	600	0,451	2
2836-1/800	800	0,560	2
2836-1/1000	1000	0,670	2

Brackets

2550/700 Bracket

- steel, rust-proof
- long handle 700 mm, short handle 300 mm
- handle width 35 mm



Art. no.	long	short	kg	PU
2550/700	700	300	0,448	1

2562/1000 Bracket

- steel, galvanised, rust-proof, with end stop
- long handle 1000 mm, short handle 500 mm
- handle width 32 mm, handle thickness 5 mm



Art. no.	long	short	kg	PU
2562/1000	1000	500	2,214	1

Measuring Tools

2640 Roller tape

- full rubber housing
- nonslip
- unbreakable
- with automatic rewind
- stop button and lock
- with clip and wrist strap



Art. No.	m	bandwidth	kg	PU
2640/3	3	16	0,115	1
2640/5	5	25	0,210	1

2705/2 Folding ruler

- fibreglass-reinforced polyamide
- surface glare-free
- scale in cm and mm on both sides
- precise angle adjustment in every joint
- 10 sections
- high measurement accuracy

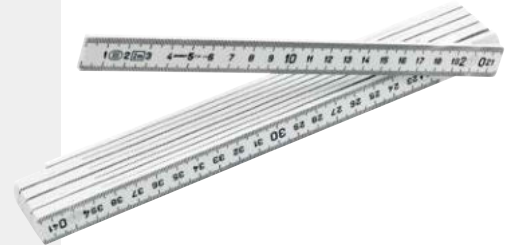

Art. No.	m	width	kg	PU
2705/2	2	14	0,137	1

2748/135 Calliper

- polished Nirosta steel
- with 1/20 mm Nonius hardened
- back with thread and weight table
- measurement range 135 mm
- scale length 160 mm
- in plastic box



Art. No.	skale	Measuring range	kg	PU
2748/135	160	135	0,161	1

2814/20 Feeler gauge

- conical leaves in metal sheath
- leaf length 100 mm
- leaf thickness 0.05 - 1.00 mm



Art. no.	↔	TMA	kg	PU
2814/20	100	0.05 - 1	0,089	6

2861/50 Plumbline

- made of woven polyethylene
- coloured, red, on a plastic roll
- thickness 1.0 mm, length 50 m



Art. no.	∅	↔ m	kg	PU
2861/50	1	50	0,040	6

2862/50 Plumbline

- made of woven polyethylene
- coloured, red, on a plastic roll
- thickness 1.7 mm, length 50 m



Art. no.	∅	↔ m	kg	PU
2862/50	1,7	50	0,046	6

Brushes

2998 Water brush

- pure China bristles



Art. no.	kg	PU
2998	0,026	12

2999-1 Flat brush

- pure China bristles



Art. no.	Width	kg	PU
2999-1/25	25	0,016	12
2999-1/50	50	0,031	12

2999 Solder water brush

- with sheet metal sheath and natural bristles



Art. no.	kg	PU
2999	0,002	50

2997 Radiator brush

- pure China bristles



Art. no.	Width	kg	PU
2997/25	25	0,021	12
2997/40	40	0,021	12

Plaster's Tools

2994/160 Plaster ladle

- galvanic zinc-coated
- with wooden handle
- tapered, Ø 160 mm



Art. no.	Ø	kg	PU
2994/160	160	0,340	1

2996/135 Plaster cup

- made of soft rubber
- Ø 135 mm



Art. no.	Ø	kg	PU
2996/135	135	0,161	5

2952 Painter's spatula

- with flat oval wooden handle



Art. no.	Width	kg	PU
2952/30	30	0,050	6
2952/40	40	0,058	6
2952/50	50	0,060	6
2952/70	70	0,080	6

Plaster's Tools

2900/60 Plasterer's spatula

- made of hardened rust-free steel
- painted wooden handle
- blade width 60 mm



Art. no.	blade width	kg	PU
2900/60	60	0,075	5

2904/140 Trowel

- square trowel
- made of hardened stainless steel
- painted wooden handle
- blade length 140 mm



Art. no.	blade length	kg	PU
2904/140	140	0,166	3

2908/160 Tongue trowel

- made of hardened stainless steel
- painted wooden handle
- blade length 160 mm



Art. no.	blade length	kg	PU
2908/160	160	0,139	5

Wire robe Tools



3466 Wire Grips | Insulated

Wire Grips for bundle assembled aerial cables (single or more core), aerial bundled conductors

- also suitable for ropes made of natural and synthetic fibers
- corrosion protection: galvanised
- easy handling, remote release possible
- self-acting and slip-resistant holding due to spring effect on the tensioned cable, even at maximum traction

WARNING: Do not exceed load capacity of the wire grips!

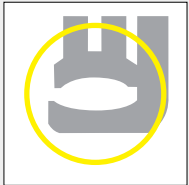

Clamping jaw profile



Art. no.	rope Ø	rope mm ²	ultim. load kg	kg	PU
3466/1	8 - 25	16 - 35	1.250	0,000	1
3466/2	16 - 34	35 - 70	3.000	0,000	1
3466/3	28 - 45	95 - 150	4.500	0,000	1

3467 Wire Grips | Universal

Wire Grips for profile bar, flat bar and rail systems

- long, parallel tension clamping jaws - not profiled; therefore no material damage
- corrosion protection: galvanised and burnished components
- easy handling, remote release possible
- self-acting and slip-resistant holding due to spring effect on the tensioned cable, even at maximum traction

WARNING: Do not exceed load capacity of the wire grips!

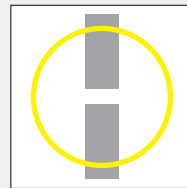

Clamping jaw profile



Art. no.	rope Ø	ultim. load kg	kg	PU
3467/1	1 - 9	2.500	0,000	1
3467/3	1 - 18	7.000	0,000	1

3468 Wire Grips | Copper and Steel

Wire Grips for copper and steel cables

- long, parallel tension clamping jaws – specifically designed; therefore no material damage
- corrosion protection: galvanised and burnished components
- easy handling, remote release possible
- self-acting and slip-resistant holding due to spring effect on the tensioned cable, even at maximum traction
- wide range of application in manufacturing, agriculture and bridge construction

WARNING: Do not exceed load capacity of the wire grips!

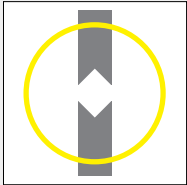

Clamping jaw profile



Art. no.	rope Ø	rope mm ²	ultim. load kg	kg	PU
3468/0	1 - 5	1 - 16	1.250	0,000	1
3468/1	3 - 9	6 - 35	2.500	0,000	1
3468/2	4 - 12	16 - 70	4.500	0,000	1
3468/3	6 - 18	50 - 150	7.000	0,000	1
3468/4	10 - 28	90 - 400	8.000	0,000	1
3468/5	20 - 40	240 - 800	9.000	0,000	1

3469 Wire Grips | Aluminium

Wire Grips for aluminium cables with and without a steel core

- long, parallel tension clamping jaws – specifically designed; therefore no material damage
- corrosion protection: galvanised
- easy handling, remote release possible
- self-acting and slip-resistant holding due to spring effect on the tensioned cable, even at maximum traction
- wide range of application in manufacturing, agriculture and bridge construction

WARNING: Do not exceed load capacity of the wire grips!

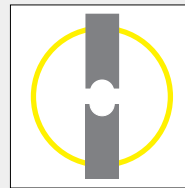

Clamping jaw profile



Art. no.	rope Ø	rope mm ²	ultim. load kg	kg	PU
3469/1	5.4 - 8.5	25 - 35	2.000	0,000	1
3469/2	5 - 12	16 - 70	3.400	0,000	1
3469/3	8 - 18	50 - 150	6.000	0,000	1
3469/4	15 - 28	120 - 400	7.000	0,000	1
3469/5	20 - 40	240 - 800	9.000	0,000	1

3462 Wire stretcher

Wire stretcher for tensioning clamping ropes, wire and rods

- high quality material: thick steel
- corrosion-protected: all steel parts are galvanised
- simple to use, free moving clamping jaws with large rivets
- low weight
- The rope clamps are optimised to make them particularly light, handy, and user-friendly.
- Their load-bearing capacity is a thousand times their dead weight for the normal versions.

WARNING: Do not exceed load capacity of the wire grips!

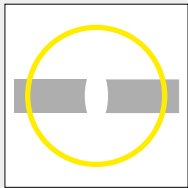

Clamping jaw profile

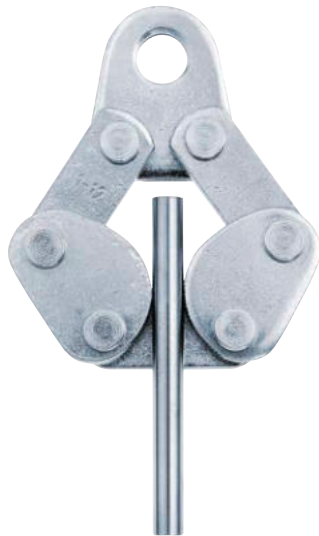

Art. no.	span Ø	ultimate load kg	kg	PU
3462/1-3	1 - 3	400	0,000	2
3462/1-4	1 - 4	500	0,000	2
3462/1-6	1 - 5	800	0,480	1
3462/1-8	1 - 8	1.200	0,620	2
3462/1-12	1 - 12	1.800	1,000	2
3462/10-25	10 - 25	3.000	0,000	2

3495/10 Hand pulley rope

- made of soft-fibre hemp
- length 10 m
- thickness 10 mm



Art. no.	↔ m	Ø	kg	PU
3495/10	10	10	1,271	1

Tool cases



7410 Tool case "plumbing"

ABS

Hard-top case

black dimensions 480 x 370 x 225 mm
 alu frame, non-slip carrying handle, 2 locks, with shoulder strap,
 reinforced metal corners as additional protection against damage

Inside:

2 tool kits completely removable, document pocket,
 bottom half of case equipped with variable partitions

Two tool boards with
 a total of 37 pockets
 and document com-
 partment (can be re-
 moved independently)



Opening angle of over
 90° prevents sudden
 folding

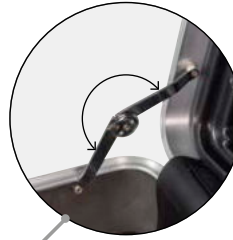

Sturdy dividers made
 of aluminum
 (can be used variably)



Reinforced metal corners
 (with integrated feet on
 the underside)



Carrying strap for higher
 carrying comfort included



Art. no.	Width	Height	Depth	kg	PU
7410	480	370	225	6,600	1

Tool cases

7419 Tool case "BRIactive"

ABS

Hard-top case, black, fitted with 23 special tools

with hook-and-loop fixing, combination lock, shoulder strap
dimensions 480 x 365 x 180 mm

Inside:

- 2 tool kits, document pocket
- bottom half of case equipped with variable partitions

Content:

- 90/10 Hexagon socket wrench 10 mm
- 90/13 Hexagon socket wrench 13 mm
- 685/240 Water pump pliers 240 mm
- 1740/300 Metal cutting saw blade
- 105/10 Plumbing installation wrench
- 211217* VDE Heavy duty side cutters HAUPA 1000 V, 170 mm
- 211208* VDE Long chain nose pliers HAUPA 1000 V, 200 mm
- 619/1 Corner pipe pliers 320 mm, 49 mm, 1"
- 633/35 Pipe cutter with deburrer
- 1470/500 Cross peen hammer 500 g
- 2524/235 All-purpose pencil 235 mm
- 1728/146 Universal bow saws
- 2122 Screwdriver set 6 pieces:
4 slot-head screwdrivers 80 x 3, 100 x 4, 125 x 5.5,
150 x 6.5 mm
2 cross-head screwdrivers PZ 1, PZ 2
- 2839 Spirit level
- 1333/200-10 Electrician's chisel 10 mm
- 2705/2 Cutting Folding ruler 2 m
- 2640/3 Roller tape 3 m, 16 mm
- 2980 Universal knife
- 2088/145 Safety voltage tester 4.0 x 145 mm
- 2999-1/25 Solder water brush 25 mm, 1"
- 2952/40 Painter's spatula 40 mm
- 631-5 Miniature pipe cutter
- 111/2 Hex key set 7 pieces: 2.5, 3, 4, 5, 6, 8, 10 mm



* perfected cutting force performance



Art. no.	set	empty	kg	PU
7419	23	7410	11,700	1

7418 Tool case "Plumbing CLASSIC"

ABS

Hard-top case, black, fitted with 22 special tools

- dimensions 480 x 370 x 225 mm
- black alu frame, non-slip carrying handle, 2 locks, with shoulder strap,
- reinforced metal corners as additional protection against damage

Inside:

- 2 tool kits completely removable, document pocket, bottom half of case
- equipped with variable partitions

Content:

- 56/10x13 Open-end wrench 10 x 13 mm
- 56/17x19 Open-end wrench 17 x 19 mm
- 114 Hex key set
- 619/1 Corner pipe pliers 320 mm, 49 mm, 1"
- 633/35 Pipe cutter with deburrer up to Ø 35 mm / 1 3/8",
up to Ø 32 mm / 1 1/4"
- 655 Combination washbasin tap wrench
- 666/2 Step wrench 2
- 680/240 Water pump pliers 240 mm
- 1333/200-10 Electrician's chisel 10 mm
- 1470/300 Cross peen hammer 300 g
- 1654-1/250 Engineer's file | half round
- 1709/40x20 Brass brush
- 1728/146 Universal bow saws
- 2142 Bit holder 350 mm
- 2142-1 Bit holder 100 mm
- 2836/300 Lightweight metal spirit level 300 mm
- 2980 Universal knife
- 2999-1/25 Solder water brush 25 mm, 1"
- 3458/10 Work gloves 10
- 4255 Safety glasses
- 2705/2 Cutting Folding ruler 2 m
- 2145 Bit set | 32 pieces | colour-coded,
1 bit holder with quick release
1 adaptor for 1/4" and 30 bits:
4x red, cross-head PH size 1, 2, 2, 3
4x green, cross-head PZ size 1, 2, 2, 3
4x blue, slot-head 3, 4, 5, 6 mm
4x yellow, Allen 3, 4, 5, 6 mm
7x orange, Tx TX 10, 15, 20, 25, 27, 30, 40
7x purple, Tx with hole STX 10, 15, 20, 25, 27, 30, 40



Art. no.	set	empty	kg	PU
7418	22	7410	11,809	1

BRINKKO
powered by haupa

7438 Tool case "Plumbing EXCLUSIPU"

ABS

Hard-top case, black, fitted with 37 special tools

- dimensions 480 x 370 x 225 mm
- black alu frame, non-slip carrying handle, 2 locks, with shoulder strap
- reinforced metal corners as additional protection against damage

Inside:

- 2 tool kits completely removable, document pocket, bottom half of case
- equipped with variable partitions

Content:

- 22-1/300 Instrument key 300 mm
- 56/10x13 Open-end wrench 10 x 13 mm
- 56/17x19 Open-end wrench 17 x 19 mm
- 92 Socket wrench 10 x 11, 12 x 13, 17 x 19, 19 x 22
- 105/10 Plumbing installation wrench
- 106-2 Plumbing four-way socket wrench
- 114 Hex key set
- 129-3/250 Reversible ratchet
- 129-7/125 Extension
- 129-12 BRImultiLock insert 10, 13, 17 mm
- 619/1 Corner pipe pliers 320 mm, 49 mm, 1"
- 631-5 Miniature pipe cutter
- 633/35 Pipe cutter with deburrer
- 655 Combination washbasin tap wrench
- 673/86 Step wrench 86 mm
- 685-1/240 Water pump pliers 240 mm
- 1333/200-10 Electrician's chisel 10 mm
- 1470/500 Cross peen hammer 500 g
- 1654-1/250 Engineer's file | half round
- 1710 Burner brush
- 1726/146 Universal bow saws
- 2070/125 Slot-head screwdriver 5.5 x 125
- 2070/150 Slot-head screwdriver 6.5 x 150
- 2080/1 Screwdriver | PZ1 x 80 / 2 - 3 mm
- 2080/2 Screwdriver | PZ2 x 100 / 3 - 5.2 mm
- 2088/145 Voltage tester
- 2524/235 All-purpose pencil 235 mm
- 2705/2 Cutting Folding ruler 2 m
- 2980 Universal knife
- 2999-1/25 Solder water brush 25 mm, 1"
- 3820 Hemp dispenser
- 2836/400 Lightweight metal spirit level 400 mm



Art. no.	set	empty	kg	PU
7438	37	7410	16,489	1

7530 Tool case "Plumbing Swimming pool EXCLUSIPU"

ABS

Hard-top case, black, fitted with 35 special tools

- dimensions 480 x 370 x 225 mm
- black alu frame, non-slip carrying handle, 2 locks, with shoulder strap,
- reinforced metal corners as additional protection against damage

Inside:

- 2 tool kits completely removable, document pocket, bottom half of case
- equipped with variable partitions

Content:

- 56 Open-end wrench 8 x 9, 10 x 11, 12 x 13, 14 x 15, 17 x 19 mm
- 114 Hex key set
- 201031 Cable stripper
- 102530 Socket wrenches DIN 7445 8 x 125 mm
- 102534 Socket wrenches DIN 7445 10 x 125 mm
- 211214 Wire stripping pliers VDE
- 211198 Combination pliers DIN ISO 5746 VDE
- 211217 Heavy duty side cutters DIN ISO 5745 VDE
- 211208 Long chain nose pliers DIN ISO 5745 VDE
- 1333/200-10 Electrician's chisel 10 mm
- 1470/300 Cross peen hammer 300 g
- 1726/146 Universal bow saws
- 1709/40x20 Brass brush
- 1728/146 Universal bow saws
- 2073-8/75 Slot-head screwdriver 2.5 x 75
- 2073-8/100 Slot-head screwdriver 4 x 100
- 2073-8/125 Slot-head screwdriver 5.5 x 125
- 2073-8/150 Slot-head screwdriver 6.5 x 150
- 2081/1 Screwdriver | PZ1 x 80 / 5 mm
- 2081/2 Screwdriver | PZ2 x 100 / 6 mm
- 2088/145 Voltage tester
- 3525 Cable stripping knife
- 516/220 Revolving punch pliers
- 210761 Crimping pliers
- 627 Combination pipe cutter
- 635-5 Plastic pipe cutter
- 660 Strap wrench
- 792/250 Punching shears
- 2999-1/25 Solder water brush 25 mm, 1"
- 2999 Solder water brush
- 103800 Voltage tester "Basic +"



Art. no.	set	empty	kg	PU
7530	35	7410	14,963	1

Tool cases

7413 "Skater" tool trolley

HDPE ★★★★★

Hardshell case made of PP plastic

dimensions 470 x 360 x 220 mm

- stiff frame made of reinforced aluminium
- 3 strong hinges on the back, strong lid support
- impact-resistant and shock-proof
- resistant to chemicals, temperature-resistant
- ergonomic, non-slip carrying handle
- telescopic handle and ball bearing mounted wheels
- 2 key-operated locks, 1 name plate

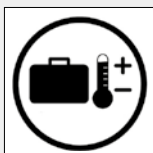

INSENSITIVU



CORROSION
FIRMLY



SHOCKRESISTANT

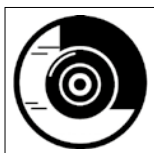

BIKES



Art. no.	Width	Height	Depth	kg	PU
7413	470	360	220	6,900	1

BRINKKO
powered by **haupa**

Tool bags



7420 Folding tool boards

Folding tool boards - Easy to take away!

- for holding tools of all kinds for different purposes
- 58 plug-in options Art. no. 7420/1
- 45 plug-in options Art. no. 7420/2
- a quick access to the tools
- Use alone or for insertion in tool case

The all-rounder for your tool!



Simply insert the tool, fold it up and take it to the construction site



For the recording of work witnesses of all kinds



Stable bolt lock with simple operation



Riveted strap as carrying handle

Art. no.	Width	Height	Depth	kg	PU
7420/1	460	310	100	1,650	1
7420/2	470	310	100	2,100	1

7000 Tool wallet

Made of plastic

- with buckle belt
- space for 5 tools Art. Nr. 7000/5
- space for 15 tools Art. Nr. 7000/15



Art. no.	Width	Height	kg	PU
7000/5	250	300	0,126	1
7000/15	680	330	0,260	1

Tool cases

7360 HDPE tool case extra deep

Tool case made of a combination of cowhide and ABS plastic

dimensions 450 x 340 x 190 mm

- partial fold-out front and back wall with a total of 17 pockets
- removable, middle tool plate with brush strip
- surrounding leather strap, two extra-large locks with keys
- filled with sanitary tools Art. no. 7362



Art. no.	Width	Height	Depth	kg	PU
7360	450	340	190	3,800	1

7362 Cowhide & ABS tool case Premium "Plumbing EXCLUSIPU"

Tool case made of a combination of cowhide and ABS plastic

dimensions 450 x 340 x 190 mm

- partial fold-out front and back wall with a total of 17 pockets
- removable, middle tool plate with brush strip
- surrounding leather strap, two extra-large locks with keys

Content:

- 22-1/300 Instrument key 300 mm
- 56/10x13 Open-end wrench 10 x 13 mm
- 56/17x19 Open-end wrench 17 x 19 mm
- 92 Socket wrench 10 x 11, 12 x 13, 17 x 19, 19 x 22
- 105/10 Plumbing installation wrench
- 106-2 Plumbing four-way socket wrench
- 114 Hex key set
- 129-3/250 Reversible ratchet
- 129-7/125 Extension
- 129-12 BRImultiLock insert 10, 13, 17 mm
- 619/1 Corner pipe pliers 320 mm, 49 mm, 1"
- 631-5 Miniature pipe cutter
- 633/35 Pipe cutter with deburrer
- 655 Combination washbasin tap wrench
- 673/86 Step wrench 86 mm
- 685-1/240 Water pump pliers 240 mm
- 1333/200-10 Electrician's chisel 10 mm
- 1470/500 Cross peen hammer 500 g
- 1654-1/250 Engineer's file | half round
- 1710 Burner brush
- 1726/146 Universal bow saws
- 2070/125 Slot-head screwdriver 5.5 x 125
- 2070/150 Slot-head screwdriver 6.5 x 150
- 2080/1 Screwdriver | PZ1 x 80 / 2 - 3 mm
- 2080/2 Screwdriver | PZ2 x 100 / 3 - 5.2 mm
- 2088/145 Voltage tester
- 2524/235 All-purpose pencil 235 mm
- 2705/2 Cutting Folding ruler 2 m
- 2980 Universal knife
- 2999-1/25 Solder water brush 25 mm, 1"
- 3820 Hemp dispenser
- 2836/400 Lightweight metal spirit level 400 mm



Art. no.	set	empty	kg	PU
7362	45	7360	11,815	1

BRINKKO[®]
powered by **haupa**

Tool cases

7515 Service bag

Strong tool bag made of hard-wearing 600D Polyester
dimensions 450 x 350 x 190 mm

- 2 full length double zips, reinforced seams
- padded carrying handle and shoulder straps
- a total of 46 storage options
- generously proportioned section with special pockets and elastic holders
- extra section for documents and other accessories



Art. no.	Width	Height	Depth	kg	PU
7515	450	350	190	2,157	1

7516 Service bag "Plumbing CLASSIC"

Strong tool bag made of hard-wearing 600D Polyester

fitted with 22 special tools
dimensions 450 x 350 x 190 mm

Content:

- 56/10x13 Open-end wrench 10 x 13 mm
- 56/17x19 Open-end wrench 17 x 19 mm
- 114 Hex key set
- 619/1 Corner pipe pliers 320 mm, 49 mm, 1"
- 633/35 Pipe cutter with deburrer
- 655 Combination washbasin tap wrench
- 666/2 Step wrench 2
- 680/240 Water pump pliers 240 mm
- 1333/200-10 Electrician's chisel 10 mm
- 1470/300 Cross peen hammer 300 g
- 1654-1/250 Engineer's file | half round
- 1709/40x20 Brass brush
- 1728/146 Universal bow saws
- 2142 Bit holder 350 mm
- 2142-1 Bit holder 100 mm
- 2836/300 Lightweight metal spirit level 300 mm
- 2980 Universal knife
- 2999-1/25 Solder water brush 25 mm, 1"
- 3458/10 Work gloves 10
- 4255 Safety glasses
- 2705/2 Cutting Folding ruler 2 m
- 2145 Bit set | 32 pieces | colour-coded,
1 bit holder with quick release
1 adaptor for 1/4" and 30 bits:
4x red, cross-head PH size 1, 2, 2, 3
4x green, cross-head PZ size 1, 2, 2, 3
4x blue, slot-head 3, 4, 5, 6 mm
4x yellow, Allen 3, 4, 5, 6 mm
7x orange, Tx TX 10, 15, 20, 25, 27, 30, 40
7x purple, Tx with hole STX 10, 15, 20, 25, 27, 30, 40



Art. no.	set	empty	kg	PU
7516	21	7515	7,366	1

Gloves



Gloves

3454 Breathable protective gloves

- Nitrile coating, pimpled
- extremely grippy due to high abrasion resistance
- very comfortable to wear, hands remain cool and dry

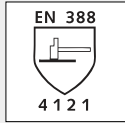

Art. no.	size	size	kg	PU
3454/9	9	L	0,043	24
3454/10	10	XL	0,043	24
3454/11	11	XXL	0,043	24

3453 Oil protection gloves

- Cotton, finely knitted, seamless
- fully coated with nitrile rubber
- perfectly suitable for working with oily and greasy objects

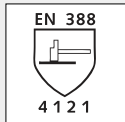

Art. no.	size	size	kg	PU
3453/9	9	L	0,105	6
3453/10	10	XL	0,105	6

3458 Work gloves

- Premium quality
- 100 % polyamide, finely knitted
- latex-coated glove palm
- repels liquid
- excellent fit

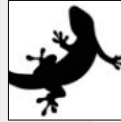
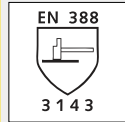

Art. no.	size	size	kg	PU
3458/9	9	L	0,105	24
3458/10	10	XL	0,063	24

3459/10 Work gloves

- Premium quality, 100 % polyamide, finely knitted
- PU-coating, excellent fit, colour white, size 10

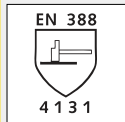

Art. no.	size	size	kg	PU
3459/10	10	XI	0,105	24

Gloves

3451/10 Cut-protection gloves

- premium quality, high-strength blended fabric, seamless
- with polyurethane inside coating.
- excellent grip, comfortable, close fit and elastic
- excellent protection (Cat. 5) when working with sharp-edged objects
CAT II, EN 388: 4-5-4-3

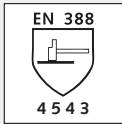

Art. no.	kg	PU
3451/10	0,105	6

Safety- and welder's goggles



Safety Glasses

4255 Safety glasses

- soft PVC
- clear glass, curved
- especially for spectacle wearers



Art. no.	kg	PU
4255	0,062	5

4265 Safety glasses

- made of plastic
- with length and height adjustable arms



Art. no.	kg	PU
4265	0,034	5

Safety glasses

- single-lens glasses
- clear lens, scratches-resistant and anti-fog
- 3M reflective strips at edge of glasses
- easy to fold up the lens
- comfortable to wear as lightweight
- optical class/impact-resistance: 1/F



Art. no.	kg	PU
4258	0,045	5

4266 Safety glasses

- made of plastic
- side protection
- clear lenses, shatterproof



Art. no.	kg	PU
4266	0,060	5

Safety glasses

- single-lens glasses
- tinted lens, scratches-resistant and anti-fog
- 3M reflective strips at edge of glasses
- easy to fold up the lens
- comfortable to wear as lightweight
- optical class/impact-resistance: 1/F



Art. no.	kg	PU
4259	0,030	5

4278 Safety glasses

- attractive design
- 2 colours to choose from: silver and blue
- simple protection level



Art. no.	Colour	kg	PU
4278-1	silver	0,023	1
4278-3	blue	0,023	1

Welder's Goggles

4250 Welder's tightly fitting safety goggles

- screw frame
- bead made of PVC
- with a head band
- interchangeable, green lenses
- Ø 50 mm, DIN 5A1



Art. no.	kg	PU
4250	0,077	5

4260 Welder's goggles

- made of nylon
- with fold-out, well ventilated side protection meshes
- interchangeable, green mineral lenses
- DIN 5 MG 1



Art. no.	kg	PU
4260	0,049	5

4280 Welder's goggles

- can be folded up; made of PVC
- with rubber head band
- lenses made of flat, colourless plastic
- folding part with replaceable, green, flat lenses, Ø 50 mm, according to DIN 5A1
- suitable for people wearing spectacles



Art. no.	kg	PU
4280	0,115	0

4261 Replacement lenses

- Ø 50 mm, shatterproof
- green Art. No. 4261, clear Art. No. 4262
- suitable for safety goggles Art. No. 4250 and 4280



Art. no.	Colour	kg	PU
4261	green	0,024	5
4262	colourless	0,034	5

4263 Replacement lenses

- green mineral lenses
- 63 x 52 mm
- suitable for safety goggles Art. No. 4260



Art. no.	kg	PU
4263	0,031	5

Safety and load securing



Protection

4210 Ear muffs

- fully insulated plastic design
- frequency ranges:
H (high) 27 dB
M (medium) 20 dB
L (low) 14 dB



Art. no.	dB	kg	PU
4210	24	0,170	1

4207 Ear plugs

- unique triple flap design
- effective protection
- SNR (averaged sound insulation): 25 dB



Art. no.	dB	kg	PU
4207	25	0,011	1

Load securing

4207 Suction Cup

Guaranteed the right Suction Cup for your application with the highest degree of security

- plastic body, 2x suction disc Ø 120 mm
 - load-bearing capacity: up to max. ◀▶ 80 kg, ▲ 40 kg
 - guideline value – use under the specified value recommended
 - handle is covered with non-slip rubber
- Can be used on all materials with smooth, sealed surfaces (e.g. panes of glass, tiles, stone, sheet steel, panels made of coated wood) Safety information:
- the surface of the object and the suction discs must not be greasy
 - before lifting a weight, carry out a test
 - never walk under the load and never lift above yourself or others



Art. no.	kN	kg	PU
1180	0,39	0,600	1

Pressing tools



Pressing tools

625-2PG Pressing Tool EFP203

Basic Line EFP203 - strong performance in a slimline design

supplied in the case: pressing tool, storage space for up to 6 press jaws PB2

- for press connections 12 - 54 (108) mm metal, 16 - 110 mm plastic
- automatic return, short pressing actions
- fits securely in your hand: 3 kg, 40 cm long (without press jaw), ergonomic shape and a 270° rotatable pressing head
- output: 450 W, piston force: 32 kN, piston stroke: 40 mm
- compatible with novopress PB2 press jaws Art. no. 625-30 to -35 and novopress PS2 press collars Art. no. 625-40 to -45



Art. No.	Pipe Ø	↔	set	kg	PU
625-2PG/EFP203	12 - 110	400	1	8,482	1
625-2SE/EFP203	12 - 110	400	4	14,193	1

Content - Pressing Tool set 625-2SE/EFP203

625-2PG/EFP203	Pressing Tool	1
PB2 Typ V oder M	Press Jaws 12 - 35 mm	3

625-2KO/EFP203 Case EFP203

- empty case, strong plastic
- space for: pressing tool EFP203
6 press jaws PB2



Art. No.	kg	PU
625-2KO/EFP203	3,378	1

625-4PG Pressing Tool ECO203

Comfort Line ECO203 - a new generation of pressing technology

Supplied in case: pressing unit, storage space for up to 6 press jaws PB2

- for press connections 12 - 54 (108) mm metal, 16 - 110 mm plastic
- fits securely in your hand: 3.2 kg, 40 cm long (without press jaw), ergonomic shape
- features: automatic sequence control, return, pressing area illumination, implemented diagnosis function, 5 m cable
- output: 450 W, piston force: 32 kN, piston stroke: 40 mm
- compatible with novopress PB2 press jaws Art. no. 625-30 to -35 and novopress PS2 press collars Art. no. 625-40 to -45



Art. No.	Pipe Ø	↔	set	kg	PU
625-4PG/ECO203	12 - 110	400	1	7,300	1
625-4SE/ECO203	12 - 110	400	4	14,114	1

Content - Pressing Tool set 625-4SE/ECO203

625-4PG/ECO203	Pressing Tool	1
PB2 Typ V oder M	Press Jaws 12 - 35 mm	3

625-4KO/ECO203 Case ECO203

- empty case, strong plastic
- space for: pressing tool ECO203 6 press jaws PB2



Art. No.	kg	PU
625-4KO/ECO203	3,348	1

Pressing tools

625-1PM Cordless Pressing Tool ACO103 BT | 4.0 Ah

Comfort Line ACO102 - compact and powerful efficiency - NEW WITH BLUETOOTH

Supplied in case: cordless pressing tool, 1 battery 12 V 4.0 Ah Li-Ion, 1 charger storage space for up to 6 press jaws PB1

- Data transfer via Bluetooth®
- for press connections 12 – 35 mm metal, 16 – 40 mm plastic
- automatic pressing process, bolt retention
- particularly suitable for tight pressing space and installation situations
- real single-handed operation: 1.7 kg light, 32 cm long (without press jaw), ergonomic shape
- LED display with electronic display: pressing force monitoring, battery charge monitoring, error messages
- output: 240 W, piston force: 19 kN, piston stroke: 30 mm
- battery: 12 V Li-Ion 4.0 Ah, battery capacity: 40 – 180 pressings, charging time: approx. 30 – 60 min
- compatible with novopress PB1 press jaws Art. no. 625-20 to -25



Art. No.	Pipe Ø	↔	set	kg	PU
625-1PM/ACO103	12 - 40	320	1	5,261	1
625-1SE/ACO103	12 - 40	320	4	9,149	1

Content - Cordless Pressing Tool set 625-1SE/ACO103

625-1PM/ACO103	Cordless Pressing Tool	1
625-1AK/ACO103	12 V rechargeable battery 4.0	1
625-1LA/ACO103	12 V charger	1
PB1 Typ V oder M	Press Jaws 12 – 35 mm	3

625-1AK/ACO103 12 V rechargeable battery 4.0

- Extremely high performance 12 V 4.0 Ah Red Li-Ion rechargeable battery for pressing tool ACO103
 - new revolutionary rechargeable battery technology
 - up to 20 % more power*, up to 2x longer service life* and 2x more charge cycles*
 - rechargeable battery capacity: depending on material and nominal widths 40 – 180 pressings
- * in comparison to other Li-Ion rechargeable batteries



Art. No.	kg	PU
625-1AK/ACO103	0,415	1

625-1LA/ACO103 12 V charger

- suitable for 12 V rechargeable batteries
- types of batteries NiCd, Red Li-Ion
- Charging time:
 - 1.5 Ah | 2.0 Ah charges in 30 – 40 min or less
 - 3.0 Ah | 4.0 Ah charges in 60 – 80 min or less
- suitable for rechargeable batteries for pressing tool ACO103



Art. No.	kg	PU
625-1LA/ACO103	0,513	1

Pressing tools

625-1K0/AC0103 Case AC0103

- empty case, strong, high quality plastic
- space for: pressing tool ACO103 with rechargeable battery, 6 press jaws PB1, replacement battery, charger



Art. No.	kg	PU
625-1K0/AC0103	2,414	1

625-5K0 Case AC0203

- empty case, strong, high quality plastic
- space for: cordless pressing tool ACO203 replacement battery | cordless pressing tool ACO203 replacement two batteries charger, 6 press jaws PB2



Art. No.	kg	PU
625-5K0/AC0203	2,100	1
625-5K0/AC0XL	4,000	1

625-5PM Cordless Pressing Tool ACO203 BT | 5.0 Ah

Comfort Line ACO203 - a new generation of pressing technology - NEW WITH BLUETOOTH

Supplied in case: cordless pressing unit,
1 rechargeable battery 18 V 5.0 Ah Li-Ion, 1 charger, storage space for up to 6 press jaws PB2

- Data transfer via Bluetooth®
- for press connections 12 – 54 (108) mm metal, 16 – 110 mm plastic
- fits securely in your hand: 2.8 kg, 39 cm long (without press jaw), ergonomic shape
- Features: pressing area illumination, implemented force monitoring and diagnosis function, innovative brushless motor technology for faster pressing process and more pressings per battery charge
- output: 450 W, piston force: 32 kN, piston stroke: 40 mm
- rechargeable battery: 18 V Li-Ion 5.0 Ah, battery capacity: up to 250 pressing processes, charging time: 60 min
- compatible with novopress PB2 press jaws Art. no. 625-30 to -35 and novopress PS2 press collars Art. no. 625-40 to -45



Art. No.	Pipe Ø	→→→	set	kg	PU
625-5PM/AC0203	12 – 110	390	1	8,300	1
625-5SE/AC0203	12 – 110	390	6	12,000	1

Content - Cordless Pressing Tool set 625-5SE/AC0203

625-5PM/AC0203	Cordless Pressing Tool	1
625-5AK/AC0203	18 V rechargeable battery 5.0	1
625-5LA/AC0203	12 – 18 V charger	1
PB2 Typ V oder M	Press Jaws 12 – 35 mm	3

Pressing tools

625-5XL/AC0203 Cordless Pressing Tool AC0203XL BT | 5.0 Ah

Comfort Line AC0203XL - the all-round expert - NEW WITH BLUETOOTH

Supplied in case: cordless pressing tool, 2x battery 18 V 5.0 Ah Li-Ion, 1 charger space

for up to 6 press jaws PB2

- Data transfer via Bluetooth®
- for press connections 12 – 108 mm metal, 16 – 110 mm plastic
- automatic pressing process, bolt retention
- fits securely in your hand: 3.9 kg (incl. battery), 46 cm long (without press jaw), ergonomic shape
- Features: status display via LED display, rotating knob, return stroke limitation
- output: 450 W, piston force: 32 kN, piston stroke: 80 mm (optionally 40 mm)
- battery: 18V Li-Ion 5.0 Ah, battery capacity: up to 250 pressing processes, charging time: 60 min
- compatible with novopress PB2 press jaws Art. no. 625-30 to -35 and novopress PS2 press collars Art. no. 625-40 to -45 and novopress PS3 press collars Art. no. 625-53



Art. No.	Pipe Ø	↔	set	kg	PU
625-5XL/AC0203	12 - 110	460	1	9,800	1

625-5AK/AC0203 18 V rechargeable battery 5.0

- extra strong rechargeable battery 18 V 5.0 Ah Red Li-Ion
 - suitable for pressing tools AC0203 | AC0203XL | AC0401 | AC0403
 - new revolutionary rechargeable battery technology
 - up to 20 % more power*, up to 2x longer service life* and 2x more charge cycles*
 - rechargeable battery capacity: depending on material and nominal widths roughly 180 pressings, integrated status display
- * in comparison to other Li-Ion rechargeable batteries



Art. No.	kg	PU
625-5AK/AC0203	0,650	1

625-5LA/AC0203 12 – 18 V charger

- suitable for 12 – 18 V rechargeable batteries
- types of batteries NiCd, Red Li-Ion
- charging time:
1.5 Ah | 2.0 Ah charges in 40 min
3.0 Ah | 4.0 Ah | 5.0 Ah charges in 75 min
- suitable for rechargeable batteries for pressing tools
AC0103 | AC0202 | AC0203 | AC0202XL | AC0203XL | AC0401 | AC0403



Art. No.	kg	PU
625-5LA/AC0203	12,800	1

BRINKKO[®]
powered by **haupa**[®]

Pressing tools

625-8PG/AC0403 Cordless Pressing Tool AC0403 BT | 5.0 Ah

Comfort Line AC0403 - Highly efficient powerhouse - NEW WITH BLUETOOTH

Supplied in the case: cordless pressing unit,
2 rechargeable batteries 18 V 5.0 Ah Red Li-Ion, 1 charger

- Data transfer via Bluetooth®
- pressing unit for large and special pipe dimensions from 76.1 up to 168,3 mm metal (e.g. sprinkler, fire extinguishing or other industrial facilities)
- strong design, weight 13 kg, length 650 mm
- electronic retaining bolt, automatic pressing cycle
- extra strong rechargeable batteries 18 V 5.0 Ah Red Li-Ion, capacity 20 - 30 pressings
- output 450 W
- piston force 120 kN, piston stroke 60 mm
- compatible with PS4 press collars Art. no. 625-63



Art. No.	Pipe Ø	↔	set	kg	PU
625-8PG/AC0403	76.1 - 168.3	650	1	13,000	1

625-8AK/AC0403 18 V rechargeable battery 5.0

- extra strong rechargeable battery 18 V 5.0 Ah Red Li-Ion
 - suitable for pressing tools AC0403
 - new revolutionary rechargeable battery technology
 - up to 20 % more power*
 - up to 2x longer service life*
 - and 2x more charge cycles*
 - rechargeable battery capacity: depending on material and nominal widths roughly 250 pressings
 - integrated status display
- * in comparison to other Li-Ion rechargeable batteries



Art. no.	kg	PU
625-8AK/AC0403	0,650	1



Case

625-K0/PB1 Case PB1

- empty case made of strong plastic
- space for: 6 press jaws PB1



Art. No.	kg	PU
625-K0/PB1	6,119	1

625-7K0/PS323 Case PS3 | small

- empty case made of strong plastic
- space for: press collars PS3 76.1 mm and 88.9 mm and the corresponding intermediate jaw ZB323



Art. No.	kg	PU
625-7K0/PS323	2,100	1

625-K0/PB2 Case PB2

- empty case made of strong plastic
- space for: 7 press jaws PB2



Art. No.	kg	PU
625-K0/PB2	6,119	1

625-7K0/PS324 Case PS3 | large

- empty case made of strong plastic
- space for: press collar PS3 108 mm and the corresponding intermediate jaws ZB323 (1st crimp) and ZB324 (2nd crimp)



Art. No.	kg	PU
625-7K0/PS324	2,100	1

625-K0/PS2 Case PS2

- empty case made of strong plastic
- space for: press collars PS2 42 mm and 54 mm and the corresponding intermediate jaw ZB203



Art. No.	kg	PU
625-K0/PS2	2,100	1

625-K0/ZBXL Case ZB2XL

- empty case made of strong plastic
- space for: intermediate jaws ZB221XL and 222XL



Art. No.	kg	PU
625-K0/ZBXL	1,650	1

BRINKO[®]
powered by **haupa**

INFO

Pipe connecting Technology

Customer-oriented warranty pressing tools:

Novopress offers a connection guarantee of one year for all new pressing tools in addition to the statutory warranty of 24 months if an annual service cycle is maintained.

Customer-oriented warranty press Jaws, collars and adaptor jaws:

Novopress offers a connection guarantee of three years for all new press jaws and one year for all new collars and adaptor jaws in addition to the statutory warranty of 24 months if an annual service cycle is maintained.

Overview of all novopress Pressing tools and Equipment

technical data	ACO103 BT	EFP203	ECO203	ACO203 BT	ACO203XL BT	ACO403 BT
dimensions metal pipe	12 – 35 mm	12 – 54 mm *	12 – 54 mm *	12 – 54 mm *	12 – 108 mm	76,1 – 168,3 mm
dimensions plastic pipe	16 – 40 mm	16 – 110 mm	16 – 110 mm	16 – 110 mm	16 – 110 mm	--
weight (incl. battery)	1,7 kg	3,0 kg	3,2 kg	2,3 kg	3,2 kg	12,8 kg
length	320 mm	395 mm	397 mm	387 mm	460 mm	650 mm
width	98 mm	81 mm	75 mm	75 mm	83 mm	95 mm
height	72 mm	203 mm	113 mm	111 mm	113 mm	320 mm
power consumption	240 W	450 W	450 W	450 W	450 W	450 W
piston force	19 kN	32 kN	32 kN	32 kN	32 kN	120 kN
piston stroke	30 mm	40 mm	40 mm	40 mm	80 mm (40 mm)	60 mm
battery electrical cable	12 V battery 4.0 Ah	5 m electrical cable	5 m electrical cable	18 V battery 5.0 Ah	18 V battery 5.0 Ah	2 x 18 V battery 5.0 Ah
battery capacity ¹⁾	40 – 180 press cycles	--	--	up to 250 press cycles	up to 250 press cycles	20 – 30 press cycles
charging time ²⁾	30 – 60 min.	--	--	60 min.	60 min.	60 – 120 min.
equipment	ACO103 BT	EFP203	ECO203	ACO203 BT	ACO203XL BT	ACO403 BT
press jaws PB1 type V	x					
press jaws PB1 type M	x					
press jaws PB1 type TH	x					
press jaws PB1 type U	x					
press jaws PB2 type V		x	x	x	x	
press jaws PB2 type M		x	x	x	x	
press jaws PB2 type TH		x	x	x	x	
press jaws PB2 type U		x	x	x	x	
adaptor jaws ZB203		x	x	x	x	
adaptor jaws ZB2XL					x	
press collars PS2 type V		x	x	x	x	
press collars PS2 type M		x	x	x	x	
press collars PS2 type TH		x	x	x	x	
press collars PS2 type U		x	x	x	x	
press collars PS3 type M					x	
press collars PS4 type HP						x

* depending on pressfitting system up to 108 mm 1) depending on dimension, material and battery 2) depending on charger

Press Jaws



Press Jaws PB1

625-20 Press Jaws PB1 type V

- special press jaws for pressing units ACO103, ACO102, AFP101 und Presskid
- for all pressing contours type V 12 - 35 mm
- high quality press jaws, light and compact design, optimal coordination with the connecting systems



Art. No.	Pipe Ø	kg	PU
625-20/PB1V12	12	1,282	1
625-20/PB1V15	15	1,272	1
625-20/PB1V18	18	1,277	1
625-20/PB1V22	22	1,328	1
625-20/PB1V28	28	1,359	1
625-20/PB1V35	35	1,282	1

625-24 Press Jaws PB1 type TH

- special press jaws for pressing units ACO103, ACO102, AFP101 und Presskid
- for all pressing contours type TH 16 - 40 mm
- high quality press jaws, light and compact design, optimal coordination with the connecting systems



Art. No.	Pipe Ø	kg	PU
625-24/PB1T16	16	1,096	1
625-24/PB1T20	20	1,156	1
625-24/PB1T26	26	1,245	1
625-24/PB1T32	32	1,476	1
625-24/PB1T40	40	1,551	1

625-23 Press Jaws PB1 type M

- special press jaws for pressing units ACO103, ACO102, AFP101 und Presskid
- for all pressing contours type M 12 - 35 mm
- high quality press jaws, light and compact design, optimal coordination with the connecting systems



Art. No.	Pipe Ø	kg	PU
625-23/PB1M12	12	1,280	1
625-23/PB1M15	15	1,281	1
625-23/PB1M18	18	1,265	1
625-23/PB1M22	22	1,326	1
625-23/PB1M28	28	1,375	1
625-23/PB1M35	35	1,282	1

625-25 Press Jaws PB1 type U

- special press jaws for pressing units ACO103, ACO102, AFP101 und Presskid
- for all pressing contours type TH 16 - 40 mm
- high quality press jaws, light and compact design, optimal coordination with the connecting systems



Art. No.	Pipe Ø	kg	PU
625-25/PB1U16	16	1,247	1
625-25/PB1U20	20	1,250	1
625-25/PB1U25	25	1,229	1
625-25/PB1U32	32	1,412	1
625-25/PB1U40	40	1,601	1

Press Jaws PB2

625-30 Press Jaws PB2 type V

- high quality press jaws for pressing units in category 2
- for all pressing contours type V 12 – 54 mm
- apart from that, PS2 press collars are used Art. no. 625-40
- recommended by many system providers



Art. No.	Pipe Ø	kg	PU
625-30/PB2V12	12	1,888	1
625-30/PB2V15	15	1,935	1
625-30/PB2V18	18	1,935	1
625-30/PB2V22	22	2,032	1
625-30/PB2V28	28	1,912	1
625-30/PB2V42	35	3,335	1
625-30/PB2V54	42	4,537	1
625-30/PB2V35	54	1,959	1

625-34 Press Jaws PB2 type TH

- high quality press jaws for pressing units in category 2
- for all pressing contours type TH 16 – 32 mm
- apart from that, PS2 press collars are used Art. no. 625-44
- recommended by many system providers



Art. No.	Pipe Ø	kg	PU
625-34/PB2T16	16	1,880	1
625-34/PB2T20	20	1,931	1
625-34/PB2T26	26	1,955	1
625-34/PB2T32	32	2,083	1

625-33 Press Jaws PB2 type M

- high quality press jaws for pressing units in category 2
- for all pressing contours type M 12 – 35 mm
- apart from that, PS2 press collars are used Art. no. 625-43
- recommended by many system providers



Art. No.	Pipe Ø	kg	PU
625-33/PB2M12	12	1,270	1
625-33/PB2M15	15	1,879	1
625-33/PB2M18	18	1,882	1
625-33/PB2M22	22	1,975	1
625-33/PB2M28	28	1,935	1
625-33/PB2M35	35	2,031	1

625-35 Press Jaws PB2 type

- high quality press jaws for pressing units in category 2
- for all pressing contours type U 16 – 32 mm
- apart from that, PS2 press collars are used Art. no. 625-45
- recommended by many system providers



Art. No.	Pipe Ø	kg	PU
625-35/PB2U16	16	1,899	1
625-35/PB2U20	20	1,885	1
625-35/PB2U25	25	1,971	1
625-35/PB2U32	32	2,089	1

Press Collars



Press Collars PS2

625-40 Press Collars PS2 type V

- press collars with „snap-on“ technology for pressing units in category 2
- for pressing contours type V 42 – 54 mm
- only in association with a universal intermediate jaw Art. no. 625-ZB/PS203



Art. No.	Pipe Ø	kg	PU
625-40/PS2V42	42	1,297	1
625-40/PS2V54	54	1,578	1

625-44 Press Collars PS2 type TH

- press collars with „snap-on“ technology for pressing units in category 2
- for pressing contours type TH 40 – 63 mm
- only in association with a universal intermediate jaw Art. no. 625-ZB/PS203



Art. No.	Pipe Ø	kg	PU
625-44/PS2T40	40	2,080	1
625-44/PS2T50	50	2,560	1
625-44/PS2T63	63	3,040	1

625-43 Press Collars PS2 type M

- press collars with „snap-on“ technology for pressing units in category 2
- for pressing contours type M 42 – 54 mm
- only in association with a universal intermediate jaw Art. no. 625-ZB/PS203



Art. No.	Pipe Ø	kg	PU
625-43/PS2M42	42	1,335	1
625-43/PS2M54	54	1,570	1

625-45 Press Collars PS2 type U

- press collars with „snap-on“ technology for pressing units in category 2
- for pressing contours type U 40 – 63 mm
- only in association with a universal intermediate jaw Art. no. 625-ZB/PS203



Art. No.	Pipe Ø	kg	PU
625-45/PS2U40	40	2,080	1
625-45/PS2U50	50	2,560	1
625-45/PS2U63	63	3,040	1

Press Collars PS3 | PS4

625-53 Press Collars PS3 type M

- press collars with „snap-on“ technology for pressing units in category 3 and for 625-5XL
- for pressing contours type M 42 - 108 mm
- only in association with a universal intermediate jaw (ZB3 or ZB2XL)



Art. No.	Pipe Ø	kg	PU
625-53/PS3M42	42	1,345	1
625-53/PS3M54	54	3,600	1
625-53/PS3M64	64	3,820	1
625-53/PS3M76	76.1	4,425	1
625-53/PS3M88	88.9	4,340	1
625-53/PS3M08	108	5,560	1

625-63 Press Collars PS4 type HP

- press collars with „snap-on“ technology for pressing unit ACO403
- for pressing contours type HP 76.1 mm, 88.9 mm, 108 mm
- other sizes available on request



Art. No.	Pipe Ø	kg	PU
625-63/PS4H76	76.1	7,400	1
625-63/PS4H88	88.9	8,000	1
625-63/PS4H08	108	9,100	1

Adaptor Jaws

625-ZB/PS203 Adaptor Jaw ZB204

- high quality intermediate jaw for novopress PS2 press collars (Art. no. 625-40 to -45)
- suitable for both, conventional press collars and also for the new „snap-on“ technology



Art. no.	Ø	kg	PU
625-ZB/PS203	40 - 63	2,032	1





625-ZB Adaptor Jaw ZB2XL

- high quality intermediate jaws especially for pressing units ACO202XL | 203XL
- suitable for the Novopress press collars PS3 Art. no. 625-53
- suitable for both conventional press collars and also for the new „snap-on“ technology



Art. no.	Pipe Ø	kg	PU
625-ZB/221XL	64 - 108 (1st pressing)	4,400	1
625-ZB/222XL	108 (2st pressing)	4,600	1
625-ZB/SETXL	64 - 108	10,800	1

Legend

	total length in mm	role/G	role weight in g
 m	total length in m	rope mm ²	Cable cross-section
 mm	span width in mm	rope Ø	Suitable for lanyard diameter
 "	Tube diameter	rope-Ø	rope diameter in mm
 mm	span width in mm	s	material thickness
Ø	diameter in mm	Sbl.	saw blade length
A	sleeve length	se	single core sector
Al	aluminium	Shaft Ø	Shaft diameter
B	flange width	size	size in mm
Balloon Ø	Balloon diameter	sm	multiple core sector
BL	blade length	span Ø	Jaw width
c	flange length	strength (St.)	strength in mm
c1	flange length 1	Tin %	Tin percentage
c2	flange length 2	TL	total length in m
CL	cutting length	TM	thread metric
Col.	colour	TMA	tested/Measured area
Cont.	content	TPI	Teeth Per Inch
content ml	content in ml	Tube Ø	Tube diameter
crimp	crimping range	v1	slim pressing
crimp coaxial	crimping range coaxial	v2	width in mm
crimp modular	crimping range modular	width (B)	width in mm
CSS	cross-section in mm	WS	wrench size
CSS rm/sm	cross-section rm/sm		
CSS/red.	conductor cross-section reduced		
Cu	copper		
Cu Ø	Copper pipe diameter		
CW	cutting width		
d1	internal diameter		
d1/red.	internal diameter reduced		
d2	hole diameter		
d4	external diameter		
db	Insulation value SNR		
depth (D)	depth in mm		
Drill Ø	Diameter drill		
drum/kg	drum weight in kg		
drum/Ø	drum diameter in mm		
drum/width	drum width in mm		
E	length to middle of hole		
H1	height 1 in mm		
height (H)	height in mm		
Hole Ø	Hole diameter		
HW	hammer weight in g		
Id.	identification number		
Id. Al	identification number Al		
Id. Cu	identification number Cu		
Inner Ø	Inner diameter		
kg/100	weight in kg/100 pcs.		
kg/h	Gas quantity in kg/h		
KlBr	Blade width		
kN	Lifting capacity		
l	length in mm		
Loc.	locator		
mat.	material		
max. ml	Cartridge capacity		
max. Ø	Max. cartridge diameter		
mm ²	diameter in mm ²		
N/Ø	nail diameter		
NL	nail length		
No.	number		
NP	nominal pressure in bar		
Ø	cross-section in mm		
Ø after	diameter after shrinkage		
Ø before	diameter before shrinkage		
Ø mm ²	Max. cable cross section		
Ø/Inch	diameter in inch		
Ø bo.	bolt diameter in mm		
Outer Ø	Outer diameter		
PE/PU	pricing/packing unit		
PU	packing unit		
PW	pressing width		

Around the cable
Working under tension
Standard program
Plumbing program

Index

Index

Art. no.	page	Art. no.	page	Art. no.	page	Art. no.	page	Art. no.	page	Art. no.	page	Art. no.	page
100241	266	101208	261	101920	209	102520	211	103	436	1044/9,5	492	110100	276
100243	266	101210	261	101922	209	102522	211	103000-1	264	1045/3,2	493	110104	276
100249	266	101211	261	101924	209	102524	211	103002-1	264	105/10	435	110108	276
100250	266	101212/S	261	101940	210	102526	211	103010	265	106	435	110112	276
100252	266	101229/6	261	101942	210	102528	211	103012	265	1060/2	492	110114	276
100257	266	101230	261	101944	210	102530	211	103014	265	1060/3	492	110120	276
100259	266	101484	263	101946	210	102532	211	103016	265	106-2	435	110130	276
100261	266	101486	263	101950	210	102534	211	103018	265	1065	492	110132	276
100366	267	101488	263	101952	210	102536	211	103020	265	1085/1	500	110140	276
100585	268	101490	263	101954	210	102538	211	103022	265	1085/2	500	110142	276
100590	269	101492	263	101956	210	102540	211	103024	265	1085/3	500	110144	276
100592	269	101494	263	101980	210	102550	210	103026	265	1086/1-5	500	110146	276
100594	269	101496	263	101999	210	102552	210	103028	265	1086/1-6	500	110148	276
100596	269	101500	263	101999/PZ	210	102554	210	103030	265	1086/1-8	500	110152	276
100598	269	101502	263	102/10	436	102556	210	103032	265	1087/5	436	110154	276
100600	269	101510	263	102/8	436	102612	260	103034-1	264	1087/7	436	110160	276
100602	269	101520	261	102000/PZ-1	212	102614	260	103070	265	1088	436	110164	276
100606	269	101521	261	102000-1	212	102616	260	103072	265	109/1	443	110170	276
100610	269	101522	261	102001	212	102700/PZ-1	214	103080	262	109/2	443	110172	276
100612	269	101524	261	102002	212	102700-1	214	103082	262	110000	226	110180	276
100614	269	101526	261	102004	212	102701/PZ-1	214	103120	262	110002	226	110182	276
100630	268	101528	261	102005	212	102701-1	214	103122	262	110004	226	110184	276
100632	268	101530	261	102006	212	102702-1	215	103130	261	110006	226	110186	276
100633	268	101532	261	102008	212	102703-1	215	103132	261	110008	226	110188	276
100634	268	101534	261	102010	212	102704-1	215	103134	261	110010	226	110190	276
100635	268	101536	261	102012	212	102705-1	215	103136	261	110012	226	110192	276
100636	268	101538	261	102014	212	102706-1	215	103470	262	110022	226	110194	276
100640	268	101540	261	102016	212	102707-1	215	103472	262	110024	226	110196	276
100645	270	101541	261	102017	212	102710	216	103498	263	110026	226	110198	276
100646	270	101542	261	102018	212	102712	216	103800	245	110028	226	110202	276
100647	270	101544	261	102020	212	102714	216	103809	245	110030	226	110204	276
100648	270	101546	261	102022	212	102716	216	103815	246	110032	226	110206	276
100649	270	101548	261	102030	212	102718	216	103817	246	110034	226	110212	276
100680	267	101550	261	102032	212	102720	216	103824	244	110036	226	110216	276
100694	267	101552	261	102034	212	102722	216	103826	244	110039/EN	234	110222	276
100700	246	101554	261	102036	212	102724	216	104/10	441	110040/EN	238	110250	276
100704	266	101560	262	102040	212	102726	216	104/3	441	110042	226	110252	276
100704 A	266	101562	262	102042-1	212	102730	216	104/4	441	110044	226	110260	226
100712	266	101604	260	102044	212	102732	216	104/5	441	110046	226	110262	226
100713	266	101606	260	102052	213	102734	216	104/6	441	110048	226	110264	226
100714	266	101608	260	102060	212	102736	216	104/8	441	110050	226	110266	226
100715	266	101610	260	102062	212	102740	216	104000	267	110052	226	110268	226
100716	266	101612	260	102064	212	102742	216	104002	267	110054	226	110270	226
100718 A	266	101614	260	102066	212	102744	216	104004	267	110055/EN	234	110272	226
100720	266	101640	260	102068	212	102746	216	104006	273	110056/EN	234	110274	226
100721	266	101642	260	102070	212	102748	216	104008-1	263	110058/EN	238	110276	226
100723	266	101644	260	102072	212	102750	216	104009	274	110060	226	110278	226
100728	266	101646	260	102110	270	102752	216	104010	266	110062	226	110280	226
100729	266	101648	260	102112	270	102760	216	104020-1	274	110064	226	110282	226
100729 A	266	101650	260	102114	270	102762	216	104022-1	274	110065/EN	234	110284	226
100734	266	101684	260	102116	270	102764	216	104030	273	110066/EN	238	110286	226
100736	266	101686	260	102118	271	102766	216	104090	213	110067/EN	238	110288	226
100738	266	101688	260	102120	271	102768	216	1044/1,0	492	110068/EN	238	110290	226
100741	266	101690	260	102124	271	102770	216	1044/1,5	492	110070	226	110300	227
100742	266	101850	210	102126	271	102772	216	1044/10,0	492	110071	234	110302	227
100902	269	101852	210	102130	271	102780	216	1044/10,5	492	110073	234	110304	227
100903	269	101854	210	102131	271	102782	216	1044/11,0	492	110074	226	110306	227
100904	269	101856	210	102132	271	102784	216	1044/11,5	492	110075	234	110308	227
100905	269	101858	210	102134	271	102785-1	214	1044/12,0	492	110076	226	110310	227
100906	269	101860	210	102152	270	102790	216	1044/12,5	492	110078	226	110312	227
100908	269	101862	210	102154	270	102792	216	1044/13,0	492	110080	226	110314	227
100909	269	101864	210	102155	270	102870	206	1044/2,0	492	110081	226	110316	227
100915	268	101866	210	102166	270	102872	206	1044/2,5	492	110083	226	110318	227
100917	268	101870	209	102172	270	102879	206	1044/3,0	492	110084	226	110320	227
100921	269	101872	209	102174	270	102914	207	1044/3,5	492	110085	226	110322	227
100927	269	101874	271	102176	271	102916	207	1044/4,0	492	110087	226	110324	227
100941	268	101876	271	102178	271	102917	207	1044/4,5	492	110089	226	110331/EN	234
100943	268	101879	209	102188	271	102918	207	1044/5,0	492	110090	276	110332/EN	238
100961	269	101880	271	102190	271	102920	207	1044/5,5	492	110091	226	110335/EN	234
100965	269	101882	271	102198	271	102942	207	1044/6,0	492	110092	276	110336/EN	238
100967	269	101910	209	102200	271	102944	207	1044/6,5	492	110093	226	110337/EN	234
101/10	436	101912	209	102204	271	102952	207	1044/7,0	492	110094	276	110338/EN	238
101200	261	101914	209	102210	272	102954	207	1044/7,5	492	110095	226	110339/EN	238
101202	261	101916	209	102212	272	102980	208	1044/8,0	492	110096	276	110340/EN	238
101204	261	101917	209	102216	272	102999	207	1044/8,5	492	110097	226	110342/EN	238
101206	261	101918	209	102512	211	102999/PZ	207	1044/9,0	492	110099	226	110344/EN	238

Art. no.	page	Art. no.	page	Art. no.	page	Art. no.	page	Art. no.	page	Art. no.	page	Art. no.	page
110346/125	238	110698	287	110754/13	281	110902	277	120060	256	129-12/32	438	1374/210x8	493
110346/250	239	110700	278	110754/14	281	110902/10	277	120062	256	129-13/13	439	1374/460x10	493
110346/EN	238	110700/EN	234	110754/15	281	110902/12	277	120064	256	129-14/6	439	1374/460x12	493
110348/125	238	110701	278	110754/16	281	110902/13	277	120069	256	129-3/250	438	1374/460x14	493
110348/250	239	110702	279	110754/17	281	110902/14	277	120070	256	129-30	439	1374/460x16	493
110348/EN	238	110702/EN	234	110754/18	281	110902/17	277	120071	256	129-7/125	440	1374/460x18	493
110350/125	238	110703/10	279	110754/19	281	110902/19	277	120072	256	129-9/1/2	440	1374/460x20	493
110350/250	239	110703/11	279	110754/20	281	110902/8	277	120073	256	130004	258	1374/460x24	493
110350/EN	238	110703/12	279	110754/21	281	110902/9	277	120074	256	130006	258	1374/600x12	493
110352/125	238	110703/13	279	110754/22	281	111/2	442	120077	256	130042	258	1374/600x16	493
110352/250	239	110703/4	279	110754/24	281	111737	280	120078	256	130044	258	1377	503
110352/EN	238	110703/45	279	110754/26	281	112/1,5	443	120079	256	130064	258	1379-3/10	497
110354/125	238	110703/5	279	110754/27	281	112/10	443	120087	252	130066	258	1379-3/12	497
110354/250	239	110703/55	279	110754/28	281	112/11	443	120088	252	130068	258	1379-3/5	497
110354/EN	238	110703/6	279	110754/30	281	112/12	443	120089	256	130200	322	1379-3/6	497
110356/125	238	110703/7	279	110754/32	281	112/13	443	120094	240	130201	322	1379-3/8	497
110356/250	239	110703/8	279	110755	281	112/14	443	120095	256	130202	322	1379-4	497
110356/EN	238	110703/9	279	110756	281	112/15	443	120096	256	130203	322	1379-6	498
110358/125	238	110704	240	110757	281	112/17	443	120100	240	130204	322	1380/114	502
110358/250	239	110705	240	110758	281	112/19	443	120101	240	130206	322	1380/121	502
110358/EN	238	110706	279	110759	279	112/2	443	120102	240	130208	322	1380/22	502
110360/125	238	110709	240	110760	279	112/2,5	443	120103	240	130209	322	1380/25	502
110360/250	239	110710	235	110780	277	112/22	443	120104	240	130210	322	1380/29	502
110360/EN	238	110711	279	110782	277	112/24	443	120106	251	130211	322	1380/32	502
110362/125	238	110712	235	110798	278	112/3	443	120109	249	130212	322	1380/35	502
110362/250	239	110713	235	110810	230	112/4	443	120111	252	130214	322	1380/38	502
110362/EN	238	110714	235	110812	230	112/5	443	120112	252	130310	296	1380/44	502
110363/EN	234	110715	235	110813	230	112/6	443	120115	252	130312	296	1380/51	502
110364/EN	234	110716	235	110814	230	112/7	443	120116	252	130314	296	1380/57	502
110365/EN	234	110717	235	110816	230	112/8	443	120120	252	130316	296	1380/64	502
110366/EN	234	110718	279	110818	230	112/9	443	120122	252	130319	298	1380/68	502
110367/EN	234	110719	279	110820	230	114	442	120160	255	130321	298	1380/75	502
110368/EN	234	110720	279	110822	230	115/2	443	120162	255	130322	296	1380-1/105	502
110369/EN	234	110721	279	110824	230	1180	558	120164	255	130323	299	1380-1/70	502
110371/EN	234	110722	279	110826	230	120002	240	120166	255	130328	297	1380-2/1	503
110373/EN	238	110723	279	110828	230	120003	249	120168	255	130336	297	1380-2/2	503
110374/EN	238	110724	279	110830	230	120004	248	120200	255	130343	301	1380-3/1	503
110375/EN	238	110725	279	110832	230	120005	248	120300/10	250	130344	300	1380-3/2	503
110376/EN	238	110726	279	110834	230	120006	248	120300/11	250	130346	300	1381	495
110377/EN	238	110727	279	110836	230	120006 561	248	120300/6	250	130348	297	1381-1/10	494
110378/EN	238	110728	279	110838	230	120006 564 S	248	120300/7	250	130352	301	1381-1/110	494
110379/EN	238	110729	279	110840	230	120006 587	248	120300/8	250	130360	302	1381-1/12	494
110456/EN	234	110731	280	110842	230	120007	248	120300/9	250	130361	302	1381-1/14	494
110457/EN	234	110733	280	110844	230	120007/1	248	120302/10	250	130364	303	1381-1/18	494
110458/EN	234	110735	280	110846	230	120008	251	120302/11	250	130366	303	1381-1/20	494
110555	227	110737/10	280	110848	230	120008 GELB	251	120302/9	250	1315/120-10	525	1381-1/25	494
110556	227	110737/11	280	110860	230	120008 ROT	251	120304/10	250	1315/120-12	525	1381-1/32	494
110557	227	110737/12	280	110861	234	120008 WEISS	251	120304/11	250	1340/250	525	1381-1/35	494
110558	224	110737/13	280	110862	238	120010	251	120304/9	250	1341/250	525	1381-1/40	494
110559	224	110737/14	280	110864	230	120011	249	120310	250	1342/200	525	1381-1/45	494
110561	224	110737/15	280	110866	230	120012	249	121020/10	248	1362	454	1381-1/50	494
110581	34	110737/16	280	110868	230	120014	252	121020/11	248	1365	454	1381-1/55	494
110583	278	110737/17	280	110869	231	120015	252	121020/9	248	1366-2/10	492	1381-1/6	494
110585	278	110737/18	280	110870	227	120016	252	121021/10	248	1366-2/14	492	1381-1/60	494
110590	277	110737/19	280	110871	231	120017	252	121022/10	248	1366-2/6	492	1381-1/68	494
110592	277	110737/20	280	110872	227	120018	252	121023/10	248	1366-2/8	492	1381-1/75	494
110594	277	110737/21	280	110873	235	120028	249	121024/10	248	1368	493	1381-1/8	494
110596	277	110737/22	280	110874	227	120029	249	122	437	1368-1/10	493	1381-1/82	494
110605	284	110737/24	280	110876	227	120030	255	123-1/110	438	1368-1/13	493	1381-4	496
110607	284	110737/6	280	110878	227	120031	255	123-7/10	439	1368-1/14	493	1381-6	496
110608	284	110737/7	280	110880	227	120033	255	123-7/13	439	1368-1/5	493	1381-7	495
110609	285	110737/8	280	110882	227	120034	251	123-7/6	439	1368-1/6	493	1382	502
110610	284	110737/9	280	110884	227	120037	249	123-7/8	439	1368-1/8	493	1384	502
110672	283	110738	280	110886	227	120040	255	127-1	437	1374/110x6	493	1385-1/10	498
110674	278	110739	280	110888	227	120041	251	127-2	439	1374/160x10	493	1385-1/12	498
110674/K	278	110741	280	110890	227	120042	255	129-100	439	1374/160x12	493	1385-1/14	498
110676	280	110745	280	110892	227	120044	255	129-12/10	438	1374/160x14	493	1385-1/5	498
110676/K	280	110747	279	110900	277	120046	255	129-12/11	438	1374/160x15	493	1385-1/6	498
110677	281	110749	279	110900/10	277	120048	255	129-12/13	438	1374/160x5	493	1385-1/8	498
110677/K	281	110751	281	110900/12	277	120049	256	129-12/14	438	1374/160x6	493	1385-6	497
110678	282	110752	281	110900/13	277	120050	256	129-12/17	438	1374/160x8	493	1386/68	498
110691	286	110753	281	110900/14	277	120051	218	129-12/19	438	1374/210x10	493	1386/82	498
110692	286	110754	279	110900/17	277	120052	218	129-12/22	438	1374/210x12	493	1391/6	525
110693	286	110754/10	281	110900/19	277	120057	256	129-12/24	438	1374/210x14	493	140180	342
110696	287	110754/11	281	110900/8	277	120058	256	129-12/26	438	1374/210x16	493	140190	342
110697	286	110754/12	281	110900/9	277	120059	256	129-12/29	438	1374/210x18	493	140192	342

Index

Art. no.	page	Art. no.	page	Art. no.	page	Art. no.	page	Art. no.	page	Art. no.	page	Art. no.	page
140210	342	143126	94	143338	98	150239	90	160050	424	170128	419	1745/300	512
140214	342	143128	94	143340	98	150240	254	160052	424	170129	419	1746/100	512
140216	342	143130	94	143342	98	150241	90	160054	424	170140	414	1746/150	512
140218	342	143132	94	143344	413	150243	90	160060	424	170141	414	1747/225	514
140220	342	143134	94	143345	413	150245	90	160062	424	170142	414	1750/150	513
140222	342	143136	94	143346	413	150247	90	160070	424	170150	414	1750/200	513
140224	342	143150	95	143348	413	150258	254	160072	424	170152	414	1750/280	513
140226	342	143152	95	143398	100	150270	254	160074	424	170153	414	1751/115	512
140228	342	143154	95	143400	100	150274	254	160090	423	170154	414	1752/200	514
140230	342	143156	95	143402	100	150275	254	160092	423	170156	415	1753/200	514
140232	342	143160	95	143404	100	150276	254	160094	423	170158	415	1754/225	513
140234	342	143162	95	143406	100	150277	254	160096	423	170160	415	1755/150	513
140236	342	143164	95	143420	102	150278	254	160100	423	170162	415	1756/75	514
140238	342	143166	95	143422	102	150279	254	160102	423	170164	416	1757/150	512
140240	342	143168	95	143424	102	150280	254	160112	423	170166	415	1757/225	512
140242	342	143170	95	143430	103	150302	255	160114	423	170170	415	1757/300	512
140244	342	143172	95	143432	103	150304	255	160130	423	170172	416	1758/105	514
140246	342	143174	95	143434	103	150306	255	160142	422	170174	413	1758/55	514
140248	342	143176	95	143440	103	150308	255	160144	422	170180	416	1759/150	513
140250	342	143178	95	143441	103	150310	255	160146	422	170200	411	1759/225	513
140252	342	143180	95	143442	103	150312	255	160150	422	170202	411	1759/280	513
140254	342	143182	95	143443	103	150314	255	160190	422	170206	410	1761/150	512
140256	342	143184	95	143444	103	150316	255	160402	424	170210	410	1761/225	512
140258	342	143186	95	143500	91	150318	255	160404	424	170212	410	1762/150	512
140260	342	143187	95	143502	91	150320	255	160406	424	170214	410	1762/225	512
140262	342	143188	97	143503	91	150322	255	160408	424	170216	410	180008	320
140510	308	143190	95	143505	91	150340	257	160414	424	170220	411	180010	320
140520	308	143200	95	143506	91	150342	257	160416	424	170222	412	180012	320
140530	308	143202	95	143507	91	150343	257	160418	424	170224	412	180042	320
1409/1000	524	143204	95	143508	91	150344	257	160420	424	170226	412	180044	320
1409/1250	524	143210	96	143509	91	150345	257	160422	424	170232	412	180062	320
1409/1500	524	143212	96	1470/300	524	150360	257	160424	424	170234	411	180064	320
143000	92	143214	96	1470/500	524	150362	257	160426	424	170236	412	180076	320
143002	92	143216	96	150002	312	150364	257	160430	424	170238	413	180082	320
143002/ECO	92	143218	96	150004	312	150366	257	160442	424	170240	413	180084	320
143004	92	143220	96	150006	312	150368	257	160444	424	170250	411	180090	320
143006	92	143222	96	150008	312	150370	257	160446	424	170254	411	180092	320
143008	92	143224	96	150010	312	150375 BLAU	257	160450	424	170400	420	180094	320
143010	92	143226	96	150012	313	150375 GRÜN	257	160452	424	170402	420	180110	320
143012	92	143228	96	150015 B	307	150375 ROT	257	160454	424	170404	420	180120	320
143014	92	143230	96	150015 G	307	150377	251	1608/60	430	170406	418	180170	320
143016	92	143232	96	150015 R	307	150450	90	1609/60	430	1705/12	520	180173	320
143018	92	143250	96	150015/1	307	150452	90	1609-1/60	430	1705/15	520	180182	321
143020	92	143252	96	150019	308	150454	90	1616/620	430	1705/18	520	180184	321
143024	92	143254	96	150024	312	150456	90	1636/40	485	1705/22	520	180186	321
143026	92	143256	96	150025	307	150458	90	1638/150	486	1705/28	520	180188	321
143028	92	143258	96	150026	312	150462	90	1640/150	486	1706/12	520	180200	321
143030	92	143260	96	150027	307	150464	90	1644/250	485	1706/15	520	180202	321
143050	93	143262	96	150028	312	150466	90	1644/500	485	1706/18	520	180232	321
143052	93	143264	96	150029	313	150468	90	1645/20	486	1706/22	520	180274	321
143054	93	143266	97	150033	313	150470	90	1646/500	486	1706/28	520	180276	321
143056	93	143270	96	150036	240	150476	90	1646-1/250-1,0	486	1706-1/15	520	180290	321
143058	93	143272	96	150037	240	150478	90	1646-1/500-1,0	486	1706-1/18	520	180292	321
143060	93	143274	96	150038	240	150480	90	1646-1/500-1,5	486	1706-1/22	520	180295	240
143062	93	143276	96	150039	313	150482	90	1649	484	1708/3	520	180297	240
143064	93	143278	96	150090	307	150560	91			1708/4	520	180300	321
143066	93	143280	96	150152	90	150562	91			1708/5	520	180302	321
143068	93	143300	98	150154	90	150601	419	1653-1/250	521	1708-1/3	520	180321	320
143070	93	143302	98	150156	90	160000	424	1654-1/250	521	1708-1/4	520	180323	321
143072	93	143304	98	150158	90	160002	424	1655-1/250	521	1709/40x20	520	180334	321
143100	94	143306	98	150200	90	160004	424	1658-1/250	521	1709-1/80	520	180346	321
143102	94	143308	98	150202	90	160006	424	1664/200	521	1710	520	180464	320
143104	94	143310	98	150204	90	160008	424	1666-1/250	521	1724/300	506	180466	320
143105	94	143312	98	150206	90	160012	424	170100	417	1726/146	506	180468	320
143106	94	143314	98	150208	90	160014	424	170101	417	1728/146	506	180470	320
143108	94	143316	98	150210	90	160016	424	170102	416	1729/146	506	180474	320
143110	94	143318	98	150220	90	160018	424	170103	417	1730/146	507	180500	334
143111	94	143320	98	150222	90	160020	424	170104	417	1731/146	507	180502	334
143112	94	143322	98	150224	90	160022	424	170106	418	1732/146	507	180504	334
143114	94	143324	98	150226	90	160024	424	170108	418	1738/300	507	180506	334
143116	94	143326	98	150228	90	160026	424	170112	418	1739/300	507	180508	334
143117	94	143328	98	150230	90	160028	424	170114	416	1740/300	507	180510	334
143118	94	143330	98	150232	90	160030	424	170116	418	1743/150	514	180512	334
143120	94	143332	98	150234	90	160042	424	170126	419	1743/200	514	180513	334
143122	94	143334	98	150236	90	160044	424	170127	419	1745/150	512	180514	334
143124	94	143336	98	150238	90	160046	424			1745/200	512	180515	334

Art. no.	page	Art. no.	page	Art. no.	page	Art. no.	page	Art. no.	page	Art. no.	page	Art. no.	page
180516	334	200105	8	200630	24	210313	291	210789	39	211682	44	212226	37
180517	334	200109	223	200632	24	210350	291	210791	46	211690	52	212228	37
180518	334	200110	223	200634	24	210388	219	210799	45	211692	52	212372	79
180519	334	200111	11	200636	26	210390	219	210802	42	211695	43	212376	79
180520	334	200112	11	200637	26	210394	291	210804	38	211697	52	212380	79
180521	334	200113	12	200638	26	210396	291	210805	46	211708	292	212382	79
180523	334	200114	12	201000	9	210397	291	210805 K	46	211720	292	212384	79
180525	334	200115	13	201002	9	210398	291	210808	42	211722	292	212388	79
180530	334	200116	12	201002/VDE	222	210556	292	210818	38	211805	39	212390	79
180532	334	200119	13	201010	225	210562	292	210819	39	211810	39	212392	79
180534	334	200120	222	201012	225	210583	220	210820	38	211816	38	212394	79
1830	448	200123	223	201040	24	210584	291	210824	38	211818	39	212396	79
190126	322	200124	15	201042	24	210588	220	210826	38	211850	293	212580	79
190130	322	200126	15	201044	24	210592	292	210827	42	211852	293	212581	79
190132	322	200127	222	201045	25	210594	292	210830	46	211854	293	212582	79
200000	225	200128	222	201046	24	210596	292	210836	46	211856	293	212583	79
200002	225	200129	222	201048	24	210616	291	210838	46	211858	293	212584	79
200003	225	200130	224	201050	24	210617	291	210840	46	211860	293	212585	79
200004	225	200131	15	201052	24	210618	291	210841	38	211862	293	212586	79
200005	225	200132	224	201054	24	210620	28	210842	38	211864	293	212587	79
200006	325	200140	326	201058	25	210622	28	210842/E	52	211866	294	212588	79
200007	225	200141	223	201059	26	210624	28	210845	42	211868	294	2126/7	447
200008	324	200149	224	201085	8	210644	291	210849	43	211870	294	2128	448
200009	225	200151	15	201086	8	210648	220	210850	46	211872	294	212804	39
200010	324	200153	7	201087	8	210682	39	210853	46	211874	294	212806	39
200011	324	200155	7	201088	8	210684	28	210857	47	211875	294	213000	47
200012	324	200170	10	2036	448	210685	29	210865	47	211876	294	213002	47
200013	225	200173	10	2066/100	446	210686	29	210867	47	211880	294	213004	47
200014	324	200175	10	2066/80	446	210691	28	210869	47	211928	31	213006	47
200016	324	200177	12	2070/125	446	210692	28	210871	47	211928/1	31	213008	47
200018	324	200178	14	2070/150	446	210693	30	210979	39	211930	31	213010	47
200021	325	200178/B	14	2073-8/100	447	210693/1	30	210979/B	39	211930/1	31	213012	47
200022	24	200178/C	14	2073-8/125	447	210695	29	211060	240	211932	31	213014	47
200023	24	200178/S	14	2073-8/150	447	210695/E	29	211062	240	211932/1	31	213020	48
200023/M	24	200178/S1	14	2073-8/75	447	210696	29	211064	240	211934	31	213022	48
200024	24	200178/S2	14	2079-18/1	447	210696/2	29	211080	292	211960	53	213024	48
200025	325	200179	13	2079-18/2	447	210697	30	211198	217	211962	53	213026	48
200025/KL	325	200181	10	2079-8/1	447	210698	29	211199	217	211963	53	213028	48
200027	325	200183	11	2079-8/2	447	210699	30	211200	217	211964	53	213030	48
200028	326	200185	7	2080/1	446	210700	257	211202	217	211965	53	213032	48
200030	326	200187	34	2080/2	446	210702	257	211203	217	211968	53	213034	48
200031	25	200188	34	2080-1/1	446	210704	257	211204	217	211969	53	213036	48
200032	325	200190	326	2080-1/2	446	210710	257	211206	217	211970	53	213038	48
200033	26	200192	326	2088/145	447	210712	257	211207	217	211971	53	213040	48
200036	25	200193	223	2088-1/145	448	210714	257	211208	217	211972	53	213042	48
200037	25	200194	326	21/250	429	210729	30	211209	217	211973	53	213044	48
200038	25	200195	223	210052	290	210730	30	211210	217	211974	53	213046	48
200039	26	200196	326	210053	290	210731	257	211211	217	211980	53	213048	48
200040	25	200197	10	210054	290	210732	257	211212	218	211981	53	213050	47
200042	25	200198	223	210056	219	210733	257	211213	217	211982	53	213077	50
200043	25	200199	11	210058	219	210761	42	211214	217	211985	53	213078	50
200044	25	200201	222	210067	290	210761/E	52	211216	218	211990	53	213080	50
200046	25	200209	325	210068	290	210762	44	211217	217	211991	53	213080/E	51
200050	25	200214	7	210069	290	210762/E	52	211219	217	211992	53	213082	43
200051	325	200215	7	210100	219	210763	38	211221	218	211993	53	213082/E	51
200057	28	200216	7	210102	219	210763/E	52	211223	218	211994	53	213084	37
200059	326	200217	7	210110	219	210764	45	211225	218	211995	53	213084/E	51
200068	26	200218	7	210117	219	210764/E	52	211226	218	211996	53	213086	50
200069	26	200219	7	210119	219	210765	38	211228	218	211997	53	213086/E	51
200072	7	200280	327	210156	290	210765/E	52	211650	38	211998	53	213088	38
200073	9	200284	327	210157	290	210767	43	211652	38	211999	53	213090	42
200073/MK	9	200285	327	210158	290	210767/E	52	211656	43	212000	53	213092	45
200081	224	200286	327	210263	221	210768	38	211657	37	212005	37	213094	44
200081/MK	224	200287	327	210264	221	210770	292	211657/E	52	212007	53	213098	51
200086	8	200288	327	210265	221	210771	45	211658	43	212008	53	213098/E	51
200086/VDE	220	200290	327	210266	221	210772	45	211659	37	2122	446	213100	51
200087	9	200292	327	210267	221	210774	45	211659/E	52	212200	37	213102	51
200088	8	200304	327	210270	219	210776	292	211660	43	212206	37	213102/E	51
200088/VDE	220	200310	327	210296	219	210777	44	211662	43	212208	37	2139	450
200089	11	200520	34	210297	221	210778	45	211672	38	212210	37	2142	450
200095	9	200520/1	34	210298	221	210779	45	211672/E	52	212212	37	2142-1	450
200095/MK	9	200522	34	210299	221	210784	52	211674	38	212214	37	2145	450
200099	9	200524	34	210300	221	210784/E	52	211676	38	212216	37	215000	54
200099/MK	9	200524/1	34	210301	221	210785	44	211676/E	52	212218	37	215002	54
200100	10	200526	34	210302	221	210786	44	211678	38	212220	37	215004	54
200104	10	200528	34	210303	219	210788	39	211680	43	212222	37	215006	54

Index

Art. no.	page	Art. no.	page	Art. no.	page	Art. no.	page	Art. no.	page	Art. no.	page	Art. no.	page
215008	54	215242	56	216018/V	72	216132	73	216428-1-N	21	216680	68	216813	68
215010	54	215244	56	216020	72	216134	73	216428-1-NO	21	216682	68	216814	67
215012	54	215246	56	216020/AL	72	216136	73	216430-1	21	216684	68	216814/AL	68
215014	54	215248	56	216020/V	72	216138	73	216430-1-N	21	216686	68	216814/V	67
215016	54	215250	56	216022	72	216140	73	216430-1-NO	21	216690	77	216815	68
215018	54	215503	78	216022/AL	72	216142	73	216434-1	20	216691	77	216816	67
215020	54	215511	78	216022/V	72	216148	73	216434-1-N	20	216760-1	61	216816/AL	68
215022	54	215513	78	216024	72	216150	73	216434-1-NO	20	216760-1-N	61	216816/V	67
215024	54	215523	78	216024/AL	72	216152	73	216435-1	20	216760-1-NO	61	216817	68
215026	54	215525	78	216024/V	72	216154	73	216435-1-N	20	216761	61	216818	67
215028	54	215527	78	216026	72	216156	73	216435-1-NO	20	216762	61	216818/AL	68
215030	54	215529	78	216026/AL	72	216160	73	216436/F-1	20	216763	61	216818/V	67
215032	54	215531	78	216026/V	72	216162	73	216436/F-1-N	20	216764	61	216819	68
215034	54	215533	78	216028	72	216164	73	216436/F-1-NO	20	216765	62	216820	67
215036	54	215641	63	216028/AL	72	216166	73	216436-1	20	216766	62	216820/AL	68
215038	54	215642	63	216028/V	72	216168	73	216436-1-N	20	216767	62	216820/V	67
215040	54	215643	63	216030	72	216170	73	216436-1-NO	20	216768	61	216821	68
215042	54	215644	63	216030/V	72	216172	73	216503-1	71	216770	87	216822	67
215044	54	215645	63	216032	72	216174	73	216503-1-N	71	216772	88	216822/AL	68
215046	54	215646	63	216032/V	72	216176	73	216503-1-NO	71	216775	88	216822/V	67
215048	54	215650	63	216036	72	216178	73	216552	73	216776	87	216823	68
215050	54	215651	63	216038	72	216180	73	216554	73	216777	87	216824	67
215100	55	215652	63	216040	72	216182	73	216556	73	216778	87	216824/AL	68
215102	55	215653	63	216042	72	216236	79	216562	73	216778/L	87	216824/V	67
215104	55	215654	63	216042/AL	72	216250	79	216564	73	216779	87	216826	67
215106	55	215655	63	216044	72	216254	78	216566	73	216779/L	87	216826/AL	68
215108	55	215765	63	216044/AL	72	216304	79	216570	73	216780	87	216826/V	67
215110	55	215770/M-1	63	216046	72	216306	79	216574	73	216780/L	87	216828	67
215112	55	215770/M-1-N	63	216046/AL	72	216308	79	216576	73	216781	87	216828/AL	68
215114	55	215770/M-1-NO	63	216048	72	216310	79	216578	73	216781/L	87	216828/V	67
215116	55	215770-1	63	216048/AL	72	216312	79	216580	73	216782	87	216830	67
215118	55	215770-1-N	63	216050	72	216314	79	216582	73	216782/L	87	216830/V	67
215120	55	215770-1-N	63	216052	72	216316	79	216601-1	69	216783	87	216831-SET	66
215122	55	215770-1-NO	63	216052/AL	72	216318	79	216601-1-N	69	216783/L	87	216832	67
215124	55	215800	64	216054	72	216320	79	216601-1-NO	69	216784	87	216834	67
215126	55	215852	64	216054/AL	72	216322	79	216622-1	70	216784/L	87	216836	67
215128	55	215854	64	216056	72	216324	79	216622-1-N	70	216785	87	216838	67
215130	55	215856	64	216056/AL	72	216326	79	216622-1-NO	70	216785/L	87	216840	67
215142	55	215858	64	216060	72	216328	79	216660	75	216786	87	216840/AL	68
215144	55	215859	64	216060/AL	72	216330	79	216660/B	76	216786/L	87	216840/AL-SET	66
215146	55	215860	64	216062/AL	72	216332	79	216660/L	76	216787	87	216842	67
215148	55	215861	64	216064	72	216334	79	216661	76	216787/L	87	216842/AL	68
215150	55	215862	64	216065	72	216336	79	216663/M-1	75	216788	87	216844	67
215152	55	215864	64	216066	72	216338	79	216663/M-1-N	75	216788/L	87	216844/AL	68
215154	55	215866	64	216067	72	216340	79	216663/M-1-NO	75	216789	87	216846	67
215156	55	215868	64	216068	72	216348	80	216663-1	75	216789/L	87	216846/AL	68
215164	55	215869	64	216069	72	216352	80	216663-1-N	75	216790	88	216848	67
215166	55	215870	64	216070	72	216355	79	216663-1-NO	75	216791	88	216850	67
215168	55	215872	64	216071	72	216357	80	216665	75	216792	88	216850/AL	68
215170	55	215881/M-1	64	216072	72	216359	88	216665-U	62	216793	88	216852	67
215172	55	215881/M-1-N	64	216074	72	216364	80	216666	76	216794	88	216852/AL	68
215200	56	215881/M-1-NO	64	216076	72	216402	18	216666-U	76	216800-1	65	216854	67
215201	56	215881-1	64	216078	72	216404	18	216666-U	62	216800-1-N	65	216854/AL	68
215202	56	215881-1-N	64	216080	72	216408	18	216667/M-1	76	216800-1-NO	65	216856	67
215203	56	215881-1-N	64	216082	72	216410	18	216667/M-1-N	76	216801/M-1	65	216856/AL	68
215204	56	215881-1-NO	64	216084	72	216415	18	216667/M-1-NO	76	216801/M-1-N	65	216858/AL	68
215205	56	215946	71	216086	72	216416	19	216667-1	76	216801/M-1-NO	65	216863	68
215206	56	215980	71	216088	73	216416/850	19	216667-1-N	76	216801-1	65	216865	68
215207	56	216004	69	216090	73	216417	19	216667-1-NO	76	216801-1-N	65	216867	68
215208	56	216005	70	216092	73	216418-1	20	216668/M-1	77	216801-1-NO	65	216869	68
215210	56	216008	72	216094	73	216418-1-N	20	216668/M-1-N	77	216802	66	216871	68
215212	56	216008/V	72	216096	73	216418-1-NO	20	216668/M-1-NO	77	216804	66	216873	68
215214	56	216010	72	216098	73	216419-1	20	216669/M-1	74	216805-SET	66	216875	68
215216	56	216010/V	72	216100	73	216419-1-N	20	216669/M-1-N	74	216806	67	216877	68
215218	56	216012	72	216112	73	216419-1-NO	20	216669/M-1-NO	74	216806/V	67	216878	67
215220	56	216012/AL	72	216114	73	216421	19	216669/M-1-NO	74	216807	66	216880	67
215222	56	216012/V	72	216116	73	216422-1	21	216669-1	74	216808	67	216882	67
215224	56	216014	72	216118	73	216422-1-N	21	216669-1-N	74	216808	67	216884	67
215226	56	216014/AL	72	216120	73	216422-1-NO	21	216669-1-NO	74	216808/V	67	216886	67
215228	56	216014/V	72	216122	73	216424-1	21	216670	68	216810	67	216888	67
215230	56	216016	72	216123	73	216424-1-N	21	216672	68	216810/V	67	216890	67
215232	56	216016/AL	72	216124	69	216424-1-NO	21	216674	68	216812/AL	68	216892	67
215234	56	216016/V	72	216125	70	216425-1	21	216676	68	216812/AL-SET	66	216894	67
215236	56	216018/AL	72	216126	73	216425-1-N	21	216678	68	216812/V	67	216896	67
215238	56	216018/AL	72	216128	73	216428-1	21					216898	67
215240	56			216130	73							216899	67

Art. no.	page	Art. no.	page	Art. no.	page	Art. no.	page	Art. no.	page	Art. no.	page	Art. no.	page
216926	67	217638	86	220229	388	220450	236	221134	406	230314/R	330	230628	331
216928	67	217640	86	220232	383	220452	236	221135	406	230314/TIN	330	230630	331
216930	67	217642	86	220235	382	220454	236	221136	406	230330	331	230634	331
216932	67	217644	86	220239	393	220456	236	221137	406	230331	331	230636	331
216934	67	217646	86	220244	389	220458	236	221138	406	230332	331	230676	335
216936	67	217650	86	220248	377	220460	236	221277	360	230334	331	230676/K	335
216938	67	217652	86	220252	384	220462	236	221278	361	230338	331	230677	335
216940	67	217654	86	220254	384	220464	236	221279	361	230340	331	230677/K	335
216942	67	217660	86	220263	397	220466	236	221280	360	230342	331	230679	335
216944	67	217662	86	220264	397	220468	236	230002	340	230344	331	230681/K	335
216946	67	217664	86	220265	355	220470	236	230010	330	230346	331	230682	342
216952	67	217666	86	220267	380	220478	236	230020	330	230352	331	230683	342
216954	67	220006	358	220268	381	220480	236	230020/CO	330	230354	331	230689	336
216956	67	220014	370	220269	379	220482	236	230030	330	230356	331	230691	336
216958	67	220016	358	220272	386	220484	236	230030/CO	330	230358	331	230701	336
216960	67	220017	227	220273	383	220486	236	230032	330	230360	331	230702	336
216962	67	220022	370	220280	359	220488	236	230032/CO	330	230362	331	230704	336
216964	67	220023	376	220281	359	220490	236	230040	330	230364	331	230705	336
216966	67	220027	380	220282	359	220492	236	230040/CO	330	230370	331	230706	336
216968	67	220028	376	220292	357	220494	236	230050	330	230372	331	230708	336
216970	67	220031	376	220293	368	220500	362	230050/CO	330	230376	331	230709	336
216972	67	220033	394	220294	368	220506	358	230060	330	230378	331	230711	336
216984	68	220038	377	220298	369	220510	363	230060/CO	330	230380	331	230720	336
216985	68	220040	388	220299	378	220550	365	230064	330	230382	331	230721	336
216986	68	220042	376	220303	394	220556	365	230064/CO	330	230395	332	230722	336
216987	68	220043	392	220307	385	220560	362	230066	330	230396	332	230723	336
216988	68	220048	377	220309	382	220576	228	230066/CO	330	230397	332	230725	336
217010	40	220053	355	220311	378	220577	228	230070	330	230398	332	230727	336
217020	40	220054	371	220313	358	220578	228	230070/CO	330	230400	331	230731	336
217030	40	220060	370	220319	396	220579	228	230080	330	230402	331	230732	331
217040	40	220061	356	220323	396	220580	228	230080/CO	330	230404	331	230734	331
217050	53	220064	370	220329	385	220581	228	230084	330	230406	331	230736	331
217052	53	220066	370	220355	405	220582	228	230084/CO	330	230408	331	230738	331
217056	53	220068	377	220356	405	220583	228	230090	330	230410	331	230740	331
217058	53	220070	370	220366	356	220584	228	230090/CO	330	230412	331	230742	331
217060	53	220076	378	220368	356	220585	228	230100	330	230414	331	230746	331
217062	53	220079	395	220370	237	220586	228	230100/CO	330	230430	332	230800	343
217064	53	220095	356	220372	402	220587	228	230110	330	230431	332	230802	343
217066	53	220103	355	220374	405	220588	228	230110/CO	330	230432	332	230804	343
217068	53	220105	355	220375	405	220589	228	230120	330	230433	332	230806	343
217070	53	220110	371	220376	405	220590	228	230120/CO	330	230434	332	230808	343
217072	53	220112	371	220377	405	220591	228	230130	330	230436	332	230810	343
217074	53	220123	218	220378	405	220592	228	230130/CO	330	230438	332	230812	343
217076	53	220126	220	220379	404	220593	228	230136	330	230438/A	332	230814	343
217078	53	220128	291	220381	138	220594	228	230136/CO	330	230438/B	332	230816	343
217080	53	220129	291	220382	118	220600	282	230140	330	230440	332	230818	343
217082	53	220130	370	220385	172	220602	406	230140/CO	330	230442	332	230820	343
217084	53	220135	374	220386	172	220608	407	230160	330	230442/A	332	230822	343
217086	53	220136	393	220387	173	220612	237	230160/CO	330	230444	332	230824	343
217088	53	220137	392	220388	173	220620	403	230170	330	230444/A	332	230826	343
217090	53	220140	375	220389	350	220622	403	230170/CO	330	230448	332	230828	343
217092	53	220141	387	220390	118	220626	404	230180	330	230450	332	230830	343
217094	53	220142	371	220391	138	220628	403	230180/CO	330	230450/A	332	230832	343
217096	53	220146	239	220392	407	220640	285	230190	330	230451	332	230834	343
217098	53	220147	235	220398	350	220642	285	230190/CO	330	230453	332	230836	343
217100	77	220148	220	220399	405	220644	406	230200	330	230454	332	230838	343
217101	77	220152/1	372	220400	395	220650	253	230200/CO	330	230456	332	230840	343
217102	77	220153	389	220402	232	220652	253	230204	330	230457	332	230842	343
217103	77	220154	372	220404	236	220653	402	230204/CO	330	230458	332	230844	343
217104	77	220156	371	220410	232	220654	404	230210	330	230459	332	230846	343
217105	77	220168	373	220412	232	220655	404	230210/CO	330	230460	332	230848	343
217107	77	220168/VDE	374	220414	232	220703	357	230220	330	230460/A	332	230850	343
2174/26	524	220169	373	220415	232	220704	357	230220/CO	330	230461	332	230852	343
217602	86	220170	387	220416	232	220705	369	230230	330	230464	332	230854	343
217604	86	220171	386	220418	232	220706	369	230230/CO	330	230466	332	230856	343
217610	86	220176	390	220420	232	220770	403	230240	330	230467	332	230858	343
217612	86	220177	391	220422	232	220800	364	230240/CO	330	230473	332	230860	343
217614	86	220179	390	220424	232	220802	363	230244	330	230474	332	230862	343
217616	86	220192	391	220426	232	220804	364	230244/CO	330	230475	332	230864	343
217618	86	220193	397	220428	232	220805	367	230250	330	230478/1	332	230866	343
217620	86	220205/EN	239	220430	232	220810	366	230250/CO	330	230479	332	230868	343
217622	86	220211	359	220432	232	220812	367	230301/TIN	330	230616	331	230870	343
217630	86	220212	235	220434	232	220814	366	230312	330	230618	331	230885/K	335
217632	86	220213	358	220436	232	22-1/300	429	230312/R	330	230620	331	230886/K	335
217634	86	220221	381	220438	232	221131	397	230312/TIN	330	230622	331	230900	332
217636	86	220224	355	220440	232	221133	397	230314	330	230626	331	230902	332

Art. no.	page	Art. no.	page	Art. no.	page	Art. no.	page	Art. no.	page	Art. no.	page	Art. no.	page
230904	332	231336	333	231962	337	250100	190	250644	192	260306	121	260431	130
230906/1	332	231338	333	231964	337	250102	190	250646	192	260306/10	125	260440	124
230908	332	231340	333	231966	337	250104	190	250648	192	260308	121	260442	124
230910	332	231342	333	231968	337	250106	190	250650	193	260310	121	260442/10	126
230912	332	231350	333	231970	337	250108	190	250652	193	260312	121	260443	124
230914	332	231352	333	231972	337	250110	190	250654	193	260314	121	260444	124
230916	332	231354	333	231974	337	250112	190	250656	193	260314/10	125	260446	123
230918	332	231502	331	231976	337	250114	190	250658	193	260316	121	260448	123
230920	332	231508	331	231978	337	250116	190	250660	193	260316/10	125	260448/10	126
230922	332	231516	331	231980	337	250118	190	250661	193	260318	121	260449	123
230924	332	231524	331	231982	337	250120	191	250662	193	260320	121	260450	123
230926	332	231526	331	231984	340	250122	191	250664	193	260322	121	260500	124
230928	332	231528	331	231998	339	250124	191	250666	193	260324	121	260502	124
230930/1	332	231530	331	231999	339	250126	191	250668	193	260324/10	125	260504	124
230932	332	231532	331	232007	339	250128	191	250670	193	260326	121	260510	123
230934	332	231540	331	232011	340	250130	191	250672	193	260328	121	260512	123
230936	332	231544	331	240002	306	250132	191	250674	193	260330	121	260514	123
230938	332	231546	331	240005	306	250140	191	250676	193	260331	121	260516	123
230940	332	231700	331	240011	306	250142	191	250678	193	260332	121	260516/10	126
230942	332	231702	331	240012	306	250144	191	250680	193	260333	121	260518	123
230944	332	231704	331	240013	306	250146	191	250682	193	260334	121	260520	123
230946	332	231706	331	240018	306	250148	191	250684	193	260335	121	260520/10	126
230948	332	231708	331	240020	306	250150	191	2511	528	260336	124	260650	127
230950	332	231710	331	240022	306	250152	191	2511-1	528	260337	124	260651	127
230952	332	231712	331	240024	306	250160	191	2511-2	528	260338	124	260654	127
230954/1	332	231714	331	240041	306	250162	191	2511-3	529	260350	122	260656	127
230956	332	231716	331	240042	306	250164	191	2513	528	260350/10	125	260658	127
230958	332	231718	331	240044	306	250166	191	2514	528	260352	122	260660	127
230960	332	231750	331	240046	306	250168	191	2515/1	529	260352/10	125	260662	127
230962/1	332	231752	331	240048	306	250170	191	2515/2	529	260354	122	260664	127
230964	332	231754	331	240057	240	250172	191	2515/3	529	260354/10	125	260665	121
230966	332	231756	331	240058	240	250174	191	2522	529	260360	122	260666	127
230968	332	231758	331	240059	306	250176	191	2523/240	529	260362	122	260667	127
230970	332	231760	331	240061	306	250178	191	2524/235	529	260364	122	260670	127
230972	332	231766	331	240071	307	250180	191	2525	530	260370	122	260672	127
230974	332	231803	338	240073	307	250182	191	2525-1	530	260371	122	260674	127
230976	332	231900	338	240132	307	250184	191	2525-2	530	260372	122	260676	127
230978	332	231901/21	338	240134	307	250186	191	2550/700	532	260373	122	260678	127
230979	332	231902	338	240136	307	250188	191	2562/1000	532	260374	122	260682	127
230982	342	231904	338	240138	307	250190	191	260243	127	260376	128	260684	127
230984	342	231904/29	338	240152	307	250192	191	260245	127	260380	122	260686	127
230986	342	231906	338	240154	307	250194	191	260246	127	260382	122	260688	127
230988	342	231908	338	240156	307	250196	191	260247	127	260384	122	260690	127
231/135	524	231910	338	240158	307	250198	191	260248	127	260386	122	260692	127
231/150	524	231912	338	240160	307	250200	191	260250	121	260386/10	126	260700	127
231050	343	231912/38	338	240234	307	250202	191	260252	121	260388	122	260702	127
231052	343	231914	338	250040	190	250204	191	260254	121	260390	122	260704	127
231054	343	231914/46	338	250042	190	250206	191	260256	121	260390/10	126	260706	127
231056	343	231916	338	250044	190	250208	191	260256/10	125	260392	122	260708	127
231058	343	231918	338	250046	190	250210	191	260258	121	260392/10	126	260710	127
231060	343	231920	338	250048	190	250212	191	260258/10	125	260394	122	260712	127
231062	343	231922	338	250050	190	250214	191	260260	121	260394/10	126	260714	127
231064	343	231924	338	250052	190	250216	191	260262	121	260396	122	260716	127
231070	343	231926	338	250054	190	250218	191	260264	121	260396/10	126	260718	127
231072	343	231928	338	250056	190	250220	191	260267	121	260400	122	260721	127
231074	343	231929	338	250058	190	250222	191	260268	121	260402	122	260722	127
231076	343	231930	338	250060	190	250224	191	260270	121	260404	122	260724	127
231080	343	231931	338	250062	190	250226	191	260270/10	125	260410	123	260726	127
231082	343	231932	338	250064	190	250228	191	260272	121	260411	123	260728	127
231280	344	231934	338	250066	190	250230	191	260272/10	125	260412	123	260730	127
231282	344	231936	338	250068	190	250600	192	260274	121	260414	123	260731	127
231300	334	231938	338	250070	190	250602	192	260274/10	125	260414/10	126	260732	127
231301	334	231939/111	338	250072	190	250604	192	260276	121	260415	123	260733	127
231302	334	231940	338	250074	190	250606	192	260278	121	260416	123	260734	127
231304	334	231940/127	338	250076	190	250608	192	260282	121	260416/10	126	260735	127
231305	334	231940/152	338	250078	190	250610	192	260284	121	260417	123	260750	128
231306	334	231940/210	338	250080	190	250611	192	260286	121	260418	123	260752	128
231307	334	231942	337	250082	190	250612	192	260288	121	260422	123	260754	128
231312	334	231944	337	250084	190	250614	192	260288/10	125	260422/10	126	260762	137
231319	333	231946	337	250086	190	250630	192	260290	121	260424	123	260764	137
231320	333	231950	337	250088	190	250632	192	260290/10	125	260424/10	126	260765	137
231322	333	231952	337	250090	190	250634	192	260292	121	260426	123	260770	128
231324	333	231954	337	250092	190	250636	192	260300	121	260426/10	126	260771	128
231326	333	231956	337	250094	190	250638	192	260302	121	260427	130	260772	128
231327	333	231958	337	250096	190	250640	192	260304	121	260428	130	260773	128
231330	334	231960	337	250098	190	250642	192	260304/10	125	260430	130	260774	128

Art. no.	page	Art. no.	page	Art. no.	page	Art. no.	page	Art. no.	page	Art. no.	page	Art. no.	page
260777	137	262120	177	262256	187	262610	177	262952	177	263396	128	263886	202
260858	148	262122	177	262258	187	262610/1	177	262952/1050	184	263400	128	263888	202
260860	148	262124	177	262260	187	262611/1	177	262952/152	184	263402	128	263890	202
260862	148	262126	177	262262	187	262612/1	177	262952/200	184	263404	128	263892	202
260863	148	262128	177	262264	187	262615	177	262952/300	184	263410	129	263894	202
260902	148	262130	177	262266	187	262616	177	262952/360	184	263412	129	263896	202
260904	148	262132	177	262268	187	262618	177	262952/520	184	263413	129	263898	202
260906	148	262134	177	262270	187	262620	177	262952/680	184	263414	129	263900	202
260908	148	262136	177	262272	187	262622	177	262952/840	184	263415	129	263902	202
260910	148	262140	179	262274	187	262623	177	262954	177	263416	129	263904	202
260912	148	262142	179	262276	187	262628	177	262956	177	263417	129	263906	202
260914	148	262144	179	262278	187	262630	177	262958	177	263418	129	263908	202
260916	148	262151	181	262280	187	262632	177	262960	177	263422	129	263910	202
260918	148	262152	181	262282	187	262634	177	262960/1000	184	263424	129	263912	202
260920	148	262153	181	262284	187	262634/1	177	262960/1200	184	263426	129	263914	202
260922	148	262154	181	262286	187	262635	177	262960/290	184	263440	129	263916	202
260924	148	262158	181	262288	187	262636	177	262960/360	184	263442	129	263918	202
260926	148	262159	184	262290	187	262637	177	262960/520	184	263443	129	263920	202
260928	148	262160	181	262292	187	262638	177	262960/680	184	263446	130	263930	203
260930	148	262161	181	262294	187	262640	177	262960/840	184	263448	130	263940	203
260932	148	262162	181	262296	187	262642	177	262962	177	263449	130	265013	106
260934	148	262163	181	262298	187	262643	177	262962/1000	184	263450	130	265014	106
260936	148	262164	181	262300	187	262645	177	262962/1200	184	263451	129	265015	106
260938	148	262165	181	262302	187	262646	177	262962/290	184	263452	129	265016	106
260940	148	262170	181	262304	187	262647	177	262962/360	184	263453	129	265017	106
260942	148	262172	181	262306	187	262700	179	262962/520	184	263456	129	265033	106
260944	148	262179	180	262308	187	262702	179	262962/680	184	263510	129	265034	106
260946	148	262180	180	262310	187	262704	179	262962/840	184	263512	129	265035	106
260948	148	262181	180	262500	176	262710	179	262964	177	263514	129	265036	106
260950	148	262182	180	262500/1	176	262750	182	262966	177	263516	129	267000	197
260952	148	262183	180	262501	177	262752	182	262968	177	263518	129	267002	197
260954	148	262184	180	262502	176	262754	182	262970	177	263520	129	267004	197
260956	148	262185	180	262503	177	262756	182	262970/1100	184	263800	202	267006	197
260960	148	262186	180	262504	176	262758	182	262970/1315	184	263802	202	267008	197
260962	148	262187	180	262505	177	262760	182	262972	177	263804	202	267010	197
260964	148	262188	180	262506	176	262762	182	262974	177	263806	202	267012	197
260966	148	262189	180	262507	177	262764	182	262976	177	263808	202	267014	197
260968	148	262190	180	262508	176	262768	182	262978	177	263810	202	267016	197
260970	148	262191	180	262509	177	262782	182	262980	177	263812	202	267018	197
260972	148	262200	186	262509/1	176	262820	179	263000	178	263814	202	267020	197
260974	148	262202	186	262510	176	262822	179	263004	178	263816	202	267022	197
260976	148	262204	186	262510/1	176	262824	179	263006	178	263818	202	267024	197
260978	148	262206	186	262511	177	262826	179	263008	178	263820	202	267026	197
260980	148	262208	186	262511/1	176	262828	179	263010	178	263822	202	267028	197
260982	148	262209	186	262512	176	262830	179	263012	178	263824	202	267030	197
260984	148	262210	186	262512/1	176	262832	179	263022	178	263826	202	267032	197
262030	182	262212	186	262513	177	262834	179	263024	178	263828	202	267034	197
262031	182	262214	186	262515	176	262840	179	263026	178	263830	202	267036	197
262032	182	262215	186	262516	176	262842	179	263028	178	263832	202	267038	197
262033	182	262216	186	262517	177	262844	179	263030	178	263834	202	267040	197
262034	182	262218	186	262518	176	262846	179	263050	178	263836	202	267042	197
262035	182	262219	186	262520	176	262848	179	263056	178	263838	202	267044	197
262036	182	262220	186	262522	176	262850	179	263058	178	263840	202	267046	197
262037	182	262222	186	262523	176	262940/125	184	263064	178	263842	202	267048	197
262048	137	262223	186	262528	176	262940/152	184	263066	178	263844	202	267050	197
262060	182	262224	186	262530	176	262940/200	184	263100	178	263846	202	267052	197
262062	182	262226	186	262532	176	262940/250	184	263102	178	263848	202	267054	197
262064	182	262227	186	262534	176	262940/300	184	263104	178	263850	202	267056	197
262066	182	262228	186	262534/1	176	262940/360	184	263106	178	263852	202	267058	197
262068	182	262230	186	262535	176	262940/520	184	263108	178	263854	202	267060	197
262069	182	262231	186	262536	176	262942/125	184	263110	178	263856	202	267062	197
262085	197	262232	186	262537	176	262942/152	184	263112	178	263858	202	267064	199
262086	197	262234	186	262538	176	262942/200	184	263200	178	263860	202	267066	199
262087	197	262235	186	262540	176	262942/250	184	263204	178	263861	202	267068	199
262088	197	262236	186	262542	176	262942/300	184	263208	178	263862	202	267070	199
262089	197	262238	186	262543	176	262942/360	184	263360	128	263864	202	267074	199
262090	197	262240	186	262545	176	262942/520	184	263362	128	263866	202	267078	199
262098	200	262242	186	262546	176	262950	177	263364	128	263868	202	267080	199
262100	177	262243	186	262547	176	262950/1050	184	263380	128	263870	202	267084	199
262101	177	262244	186	262600	177	262950/152	184	263382	128	263872	202	267088	199
262102	177	262245	186	262600/1	177	262950/200	184	263384	128	263874	202	267090	199
262106	177	262246	186	262602	177	262950/300	184	263386	128	263876	202	267092	199
262108	177	262247	186	262604	177	262950/360	184	263388	128	263878	202	267094	199
262110	177	262248	186	262606	177	262950/520	184	263392	128	263880	202	267096	199
262114	177	262249	186	262608	177	262950/680	184	263393	128	263882	202	267098	199
262116	177	262254	187	262609/1	177	262950/840	184	263394	128	263884	202	267100	199

Index

Art. no.	page	Art. no.	page	Art. no.	page	Art. no.	page	Art. no.	page	Art. no.	page	Art. no.	page
267102	199	267342	198	270036	112	270141	108	270778/25	114	270882/DIN	117	280104/20	144
267104	199	267344	198	270038	112	270142	108	270780	113	270888	116	280105	142
267106	199	267346	198	270040	112	270142/500	108	270780/25	114	270890	116	280110	141
267108	199	267348	198	270042	112	270143	108	270782	113	270891	116	280111	142
267110	199	267352	198	270044	112	270143/500	108	270784	113	270892	116	280114	141
267112	199	267354	198	270046	112	270144	108	270784/25	114	270893	116	280115	142
267114	199	267356	198	270048	112	270146	108	270787	113	270894	117	280120	142
267116	199	267358	198	270049	112	270146/500	108	270788	113	270895	117	280124	142
267118	199	267360	198	270050	112	270148	108	270788/25	114	270896	117	280128	142
267120	199	267362	198	270066	109	270148/500	108	270790	113	270897	117	280132	142
267132	197	267364	198	270066/500	109	270149	108	270792	113	270899	117	280136	142
267134	197	267366	198	270068	109	270149/500	108	270792/25	114	270900	113	280140	142
267136	197	267368	198	270068/500	109	270150	108	270794	113	270902	113	280150	142
267138	197	267372	198	270070	109	270150/500	108	270795	115	270904	113	280154	142
267140	197	267374	198	270070/500	109	270152	108	270796	113	270906	113	280158	142
267142	197	267376	198	270072	109	270152/500	108	270796/10	114	270908	113	280162	142
267144	197	267378	198	270072/500	109	270154	108	270797	113	270910	113	280166	142
267146	197	267380	198	270074	109	270154/500	108	270797/10	114	270912	113	280170	142
267200	196	267382	198	270074/500	109	270156	108	270798	113	270914	113	280180	143
267202	196	267384	198	270076	109	270156/500	108	270798/5	114	272250	111	280182	143
267204	196	267386	198	270077	109	270158	108	270799	113	272254	111	280184	143
267206	196	267388	198	270078	109	270158/500	108	270799/5	114	272260	111	280186	143
267250	198	267392	198	270078/500	109	270159	108	270800	110	272264	111	280188	143
267250/200	197	267394	198	270079	109	270159/500	108	270800/25	114	272268	111	280190	143
267252	198	267396	198	270079/500	109	270160	108	270801	110	272280	111	280192	143
267252/200	197	267398	198	270080	109	270160/500	108	270802	110	272284	111	280194	143
267254	198	267400	198	270082	109	270164	108	270803	110	272290	111	280196	143
267254/200	197	267402	198	270082/500	109	270164/500	108	270803/25	114	272294	111	280198	143
267256	198	267404	198	270084	109	270166	108	270804	110	272298	111	280200	143
267256/200	197	267406	198	270084/500	109	270166/500	108	270804/25	114	272721	112	280202	143
267258	198	267408	198	270086	109	270168	108	270805	110	272723	112	280204	143
267258/100	197	267410/25	197	270086/500	109	270168/500	108	270806	110	272725	112	280206	143
267260	198	267411/25	197	270087	109	270170	108	270807	110	272803	110	280208	143
267260/50	197	267412/25	197	270088	109	270172	108	270808	110	272804	110	280210	143
267262	198	267413/25	197	270089	109	270174	108	270808/25	114	272812	110	280212	143
267262/50	197	267430	198	270089/500	109	270176	108	270809	110	273350	114	280214	143
267264	198	267432	198	270090	109	270178	108	270810	110	273352	114	280460	143
267264/100	197	267434	198	270090/500	109	270180	108	270810/25	114	273354	114	280482	143
267266	198	267436	198	270091	109	270182	108	270811	110	273356	114	280490	143
267266/50	197	267438	198	270091/500	109	270184	108	270812	110	273358	114	280512	143
267268	198	267440	198	270092	109	270186	108	270813	110	273360	114	280520	143
267268/50	197	267442	198	270092/500	109	270188	108	270814	110	273362	114	280542	143
267272	198	267444	198	270093	109	270190	108	270814/25	114	273364	114	280550	143
267274	198	267446	198	270093/500	109	270192	108	270815	110	273366	114	280572	143
267276	198	267448	198	270094	109	270194	108	270816	110	273368	114	280580	143
267278	198	267450	198	270096	109	270195	108	270818	110	273392	114	280582	143
267280	198	267452	198	270097	109	270196	108	270818/10	114	273394	114	2814/20	532
267282	198	267460	200	270098	109	270198	108	270820	110	273396	114	2836/1000	531
267282/50	197	267462	200	270100	109	270217	115	270822	110	280000	140	2836/300	531
267284	198	267464	200	270102	109	270218	115	270822/10	114	280000/20	144	2836/400	531
267284/100	197	267466	200	270104	109	270714	112	270824	110	280004	140	2836/600	531
267286	198	267468	200	270106	109	270715	112	270826	110	280004/20	144	2836/800	531
267288	198	267470	200	270107	109	270716	112	270826/10	114	280008	140	2836-1/1000	531
267292	198	267472	200	270108	109	270719	112	270828	110	280008/20	144	2836-1/400	531
267294	198	267480/100	197	270110	109	270720	112	270830	110	280012	140	2836-1/600	531
267296	198	267500	200	270112	109	270721	112	270830/5	114	280016	140	2836-1/800	531
267298	198	267502	200	270114	109	270722	112	270832	110	280020	140	2845	454
267300	198	267506	200	270116	109	270723	112	270834	110	280030	140	2861/50	533
267302	198	267508	200	270118	109	270724	112	270836	110	280034	140	2862/50	533
267304	198	267510	200	270119	109	270725	112	270836/5	114	280038	140	2900/60	534
267306	198	267512	200	270120	109	270726	112	270838	110	280042	140	290001	159
267308	198	267514	200	270121	109	270727	112	270840	110	280046	140	290003	159
267312	198	27/300	429	270122	109	270728	112	270842	110	280050	140	290004	154
267314	198	270014	112	270123	109	270738	112	270844	110	280060	140	290005	159
267316	198	270015	112	270124	109	270740	112	270850	115	280064	140	290006	154
267318	198	270016	112	270126	109	270742	112	270852	115	280070	140	290006/90	155
267320	198	270021	112	270128	109	270744	112	270854	115	280074	140	290007	159
267322	198	270022	112	270130	109	270746	112	270856	115	280080	141	290008	154
267324	198	270027	112	270131	109	270748	112	270858	115	280084	141	290008/90	155
267326	198	270028	112	270132	109	270750	112	270859	110	280084/20	144	290009	154
267328	198	270029	112	270134	109	270754	112	270861	110	280090	141	290010	154
267332	198	270030	112	270135	109	270756	112	270863	110	280094	141	290010/90	155
267334	198	270031	112	270136	109	270758	112	270864	116	280100	141	290011	159
267336	198	270032	112	270137	109	270760	112	270866	116	280100/20	144	290012	154
267338	198	270033	112	270140	108	270762	110	270870	115	280101	142	290013	159
267340	198	270034	112	270140/500	108	270778	113	270882	117	280104	141	290014	154

Art. no.	page	Art. no.	page	Art. no.	page	Art. no.	page	Art. no.	page	Art. no.	page	Art. no.	page
290014/90	155	290250	158	290426/10	162	290652	147	290810	157	290956	153	291108	150
290015	159	290252	158	290428	161	290654	147	290812	157	290956/90	154	291110	150
290016	154	290254	158	290428/10	162	290656	147	290814	157	290958	153	291112	150
290016/90	155	290256	158	290430	161	290658	147	290816	157	290958/90	154	291114	150
290017	154	290258	158	290432	161	290660	147	290818	157	290960	153	291119	150
290018	154	290260	158	290434	161	290662	147	290820	157	290960/90	154	291120	150
290018/90	155	290262	158	290434/10	162	290663	147	290822	157	290962	153	291124	150
290019	159	290264	158	290436	161	290664	147	290824	157	290962/90	154	291126	150
290020	154	290266	158	290436/10	162	290666	147	290826	157	290964	153	291128	150
290020/90	155	290268	158	290438	161	290668	147	290830	157	290964/90	154	291130	150
290021	159	290270	158	290440	161	290670	147	290832	157	290966	153	291132	150
290022	154	290272	158	290442	161	290672	147	290834	157	290966/90	155	291134	150
290022/90	155	290276	158	290444	161	290676	147	290836	157	290968	153	291136	150
290023	154	290278	158	290446	161	290678	147	290840	157	290968/90	155	291138	150
290024	154	290280	158	290448	161	290680	147	290842	157	290970	153	291140	150
290024/90	155	290282	158	290450	161	290682	147	290844	157	290970/90	155	291142	150
290025	159	290284	158	290452	161	290684	147	290846	157	290972	153	291330	156
290026	154	290286	158	290454	161	290686	147	290848	157	290972/90	155	291332	156
290027	159	290288	158	290456	161	290688	147	290850	157	290974	153	291334	156
290028	154	290290	158	290458	161	290690	147	290852	157	290976	153	291336	156
290028/90	155	290292	158	290460	161	290692	147	290854	157	290976/90	155	291338	156
290029	154	290294	158	290462	161	290694	147	290856	157	290978	153	291340	156
290030	154	290296	158	290464	161	290696	147	290858	157	290978/90	155	291342	156
290030/90	155	290300	158	290466	161	290698	147	290860	157	290980	153	291344	156
290031	159	290302	158	290468	161	290700	147	290862	157	290980/90	155	291348	156
290033	159	290304	158	290470	161	290701	147	290864	157	290982	153	291350	156
290034	154	290306	158	290472	161	290702	147	290866	157	290982/90	155	291352	156
290035	159	290308	158	290474	161	290704	147	290868	157	290984	153	291354	156
290036	154	290310	158	290476	161	290707	147	290870	157	290985	153	291356	156
290037	159	290316	158	290478	161	290708	147	290872	157	290986	153	291358	156
290038	154	290318	158	290480	161	290710	147	290874	157	290986/90	155	291360	156
290039	159	290320	158	290482	161	290712	147	290876	157	290988	153	291440	160
290040	154	290322	158	290484	161	290713	147	290878	157	290988/90	155	291442	160
290041	154	290324	158	290486	161	290714	147	290880	157	290990	153	291444	160
290042	159	290326	158	290488	161	290716	147	290882	157	290990/90	155	291446	160
290043	154	290328	158	290490	161	290717	147	290884	157	290991	153	291448	160
290044	159	290330	158	290492	161	290718	147	290886	157	290992	153	291450	160
290045	154	290332	158	290494	161	290719	147	290900	153	290992/90	155	291452	160
290046	154	290334	158	290496	161	290720	147	290902	153	290994	153	291454	160
290047	154	290336	158	290498	161	290721	147	290904	153	290994/90	155	291456	160
290048	154	290338	158	290516	161	290730	149	290906	153	290996	153	291458	160
290049	159	290350	158	290518	161	290731	149	290908	153	290996/90	155	291460	160
290050	159	290352	158	290520	161	290732	149	290910	153	290998	153	291462	160
290051	159	290354	158	290522	161	290734	149	290912	153	290998/90	155	291464	160
290052	159	290356	158	290561	162	290735	149	290914	153	290999	153	291520	160
290053	159	290358	158	290562	162	290736	149	290916	153	291000	153	291521	163
290054	159	290360	158	290563	162	290738	149	290918	153	291000/90	155	291522	160
290055	159	290362	158	290564	162	290739	149	290920	153	291002	153	291523	163
290056	159	290364	158	290565	162	290740	149	290922	153	291002/90	155	291524	160
290057	159	290366	158	290566	162	290742	149	290924	153	291004/90	155	291525	163
290058	159	290368	158	290567	162	290744	149	290926	153	291050	155	291526	160
290059	159	290370	158	290568	162	290746	149	290928	153	291052	155	291527	163
290060	159	290372	158	290569	162	290748	149	290930	153	291054	155	291528	160
290061	159	290374	158	290570	162	290750	149	290932	153	291056	155	291529	163
290063	159	290380	171	290571	162	290751	149	290932/90	154	291058	155	291530	160
290064	159	290382	171	290572	162	290752	149	290934	153	291060	155	291531	163
290065	159	2904/140	534	290617	147	290754	149	290934/90	154	291062	155	291532	160
290066	159	290404	161	290619	147	290756	149	290936	153	291064	155	291533	163
290067	159	290404/10	162	290620	147	290770	149	290936/90	154	291066	155	291534	160
290068	159	290406	161	290621	147	290771	149	290938	153	291068	155	291535	163
290069	159	290406/10	162	290622	147	290773	149	290938/90	154	291070	155	291536	160
290070	159	290408	161	290623	147	290775	149	290940	153	291072	155	291537	163
290071	159	290410	161	290624	147	290776	149	290940/90	154	291074	155	291538	160
290072	159	290410/10	162	290625	147	290777	149	290942	153	291076	155	291539	163
290073	159	290412	161	290626	147	290778	149	290942/90	154	291078	155	291540	160
290074	159	290412/10	162	290627	147	290780	149	290944	153	291080	155	291541	163
290075	159	290414	161	290628	147	290782	149	290944/90	154	291082	155	291542	160
290076	159	290416	161	290630	147	290784	149	290946	153	291084	155	291543	163
290077	159	290416/10	162	290632	147	290786	149	290948	153	291090	150	291544	160
290078	159	290418	161	290634	147	290788	149	290948/90	154	291092	150	291545	163
290079	159	290418/10	162	290635	147	2908/160	534	290950	153	291096	150	291546	160
290080	159	290420	161	290636	147	290800	157	290950/90	154	291098	150	291547	163
290081	159	290420/10	162	290637	147	290801	157	290952	153	291100	150	291548	160
290082	159	290422	161	290646	147	290802	157	290952/90	154	291102	150	291549	163
290083	159	290424	161	290648	147	290804	157	290954	153	291104	150	291550	160
290084	159	290426	161	290650	147	290806	157	290954/90	154	291106	150	291551	163

Art. no.	page	Art. no.	page	Art. no.	page	Art. no.	page	Art. no.	page	Art. no.	page	Art. no.	page
291552	160	292794	166	293546	167	294070	151	294542	165	340392	131	363604	136
291553	163	292796	166	293548	167	294080	151	294544	165	340394	131	363606	136
291554	160	292798	166	293550	167	294082	151	294546	165	340396	131	363607	136
291555	163	292800	166	293552	167	294084	151	294548	165	340414	132	363608	136
291700	163	292802	166	293554	167	294086	151	294550	165	340416	132	3700/3	467
291702	163	292804	166	293556	167	294088	151	294552	165	340422	132	3700/5	467
291704	163	292806	166	293558	167	294094	151	294554	165	340424	132	3701/10	467
291706	163	292808	166	293578	168	294096	151	294556	165	340426	132	3701/3	467
291708	163	292810	166	293582	168	294098	151	294558	165	3451/10	551	3701/5	467
291710	163	292812	166	293584	168	294100	151	294560	165	3453/10	550	3702/5	467
291712	163	292814	166	293598	168	294102	151	294562	165	3453/9	550	3702/8	467
291714	163	292816	166	293600	168	294106	151	294564	165	3454/10	550	370256	133
291716	163	292818	166	293606	168	294108	151	294566	165	3454/11	550	370258	133
291718	163	292820	166	293608	168	294110	151	294568	165	3454/9	550	370270	133
291720	163	292822	166	293610	168	294112	151	294570	165	3458/10	550	370272	133
291722	163	292824	166	293622	168	294114	151	294580	165	3458/9	550	370274	133
291724	163	292904	166	293624	168	294118	151	294582	165	3459/10	550	370288	133
291726	163	292906	166	293626	168	294120	151	294584	165	3462/10-25	538	370290	133
291728	163	292908	166	293634	168	294122	151	294586	165	3462/1-12	538	370304	133
291730	163	292910	166	293636	168	294124	151	294588	165	3462/1-3	538	370314	133
291732	163	292912	166	293638	168	294128	151	294590	165	3462/1-4	538	370322	133
291734	163	292914	166	293652	168	294130	151	294592	165	3462/1-6	538	370350	133
291736	163	292916	166	293654	168	294132	151	294594	165	3462/1-8	538	370352	133
291738	163	292918	166	293656	168	294134	151	294596	165	3466/1	536	370354	133
291740	163	292920	166	293664	168	294138	151	294598	165	3466/2	536	370392	133
291742	163	292922	166	293666	168	294140	151	2952/30	534	3466/3	536	370394	133
291744	163	292924	166	293678	168	294142	151	2952/40	534	3467/1	536	370396	133
291746	163	292926	166	293680	168	294144	151	2952/50	534	3467/3	536	370414	134
291748	163	292928	166	293688	168	294150	152	2952/70	534	3468/0	537	370416	134
291750	163	292930	166	293690	168	294152	152	2980	516	3468/1	537	370422	134
291752	163	292932	166	293810	168	294154	152	2982	516	3468/2	537	370424	134
291754	163	292934	166	293812	168	294160	152	2991	516	3468/3	537	370426	134
291756	163	292936	166	293814	168	294162	152	2992	516	3468/4	537	3712/10x12	467
291758	163	292938	166	293816	168	294164	152	2993	517	3468/5	537	3712/10x15	467
291760	163	292940	166	293960	167	294174	152	2994/160	534	3469/1	537	3712/5x10	467
291762	163	292942	166	293962	167	294176	152	2996/135	534	3469/2	537	3712/5x15	467
291764	163	292944	166	293964	167	294184	152	2997/25	533	3469/3	537	3713/10x10	468
291766	163	292946	166	293966	167	294196	152	2997/40	533	3469/4	537	3713/10x12	468
291768	163	292948	166	293968	167	294200	152	2998	533	3469/5	537	3713/5x10	468
291770	163	292950	166	293970	167	294202	152	2999	485	3495/10	538	3713/5x12	468
291772	163	293130	170	293972	167	294204	152	2999-1/25	533	3525	516	3714/10	467
291774	163	293132	170	293974	167	294206	152	2999-1/50	533	3526	516	3714/5	467
291776	163	293134	170	293976	167	294208	152	300033	48	3552/3	530	3720	466
291778	163	293136	170	293978	167	294210	152	300102	311	3552/4	530	3720-1	466
291780	163	293138	170	294000	151	294212	152	300115	311	3552/6	530	3720-2	466
291782	163	293140	170	294002	151	294214	152	300116	411	3552/8	530	3722	466
292560	164	293142	170	294004	151	294218	152	300117	312	3562/6	530	3730/1	468
292562	164	293144	170	294006	151	294220	152	300228	253	363500	135	3730/2	468
292564	164	293146	170	294008	151	294222	152	300229	253	363500/10	136	3740	472
292566	164	293148	170	294010	151	294224	152	300294/EN	239	363502	135	3740-1	472
292568	164	293150	170	294012	151	294226	152	300295/EN	239	363502/10	136	3740-2	472
292570	164	293152	170	294014	151	294228	152	300296/EN	235	363504	135	3740-3	472
292572	164	293154	170	294016	151	294230	152	300297/EN	239	363504/5	136	3740-4	472
292574	164	293156	170	294018	151	294232	152	300298/EN	235	363510	135	3740-5	473
292580	164	293300	167	294020	151	294234	152	300299/EN	235	363512	135	3740-6	473
292582	164	293302	167	294022	151	294500	165	300302/EN	235	363514	135	3740-7	473
292584	164	293304	167	294024	151	294502	165	300303/EN	239	363520	135	3740-8	473
292586	164	293306	167	294026	151	294504	165	300305/EN	235	363522	135	3750	473
292588	164	293308	167	294028	151	294506	165	300306/EN	239	363524	135	3750-1	473
292590	164	293310	167	294034	151	294508	165	300310/EN	234	363530	136	3750-2	474
292592	164	293312	167	294036	151	294510	165	300312/EN	238	363532	136	3750-3	474
292596	164	293314	167	294038	151	294512	165	300322	26	363534	136	3760	474
292598	164	293316	167	294040	151	294514	165	300420	253	363536	136	3760-1	474
292600	164	293318	167	294044	151	294516	165	340256	131	363538	136	3760-2/100	475
292770	166	293320	167	294046	151	294518	165	340258	131	363540	136	3760-2/60	475
292772	166	293322	167	294048	151	294520	165	340270	131	363542	136	3760-3	475
292774	166	293324	167	294050	151	294522	165	340272	131	363544	136	3760-5	475
292776	166	293326	167	294052	151	294524	165	340274	131	363546	136	3760-6	475
292778	166	293328	167	294054	151	294526	165	340288	131	363548	136	3760-7/1	475
292780	166	293330	167	294056	151	294528	165	340290	131	363550	136	3760-7/2	475
292782	166	293332	167	294058	151	294530	165	340304	131	363552	136	3760-7/3	475
292784	166	293334	167	294060	151	294532	165	340314	131	363554	136	3760-8	475
292786	166	293336	167	294062	151	294534	165	340322	131	363556	136	3800-1/1	468
292788	166	293338	167	294064	151	294536	165	340350	131	363558	136	3800-1/2	468
292790	166	293542	167	294066	151	294538	165	340352	131	363600	136	3800-1/3	468
292792	166	293544	167	294068	151	294540	165	340354	131	363602	136	3800-1/4	468

Art. no.	page	Art. no.	page	Art. no.	page	Art. no.	page	Art. no.	page	Art. no.	page	Art. no.	page
3800-2	468	393038	310	5100/350	483	625-1K0/	561	625-34/	569	627	460	655	452
3800-3	469	393040	310	516/220	430	ACO103		PB2T26		627-1	460	655-1/10	452
3805/1	469	393107	313	5200	483	625-1LA/	561	625-34/	569	627-2	460	655-1/11	452
3805/2	469	393150	314	5205	483	ACO103		PB2T32		627-4	460	655-1/12	452
3805/3	469	393152	314	5210	484	625-1PM/	561	625-35/	569	628/140	460	655-1/14	452
3805/4	469	393154	314	522	430	ACO103		PB2U16		628-1	460	655-1/32	452
3805/5	469	393156	314	543/120	431	625-1SE/	561	625-35/	569	629/2	460	655-1/9	452
3806/1	469	3936/1-2	490	546/130	431	ACO103		PB2U20		629/4	460	659	453
3806/2	469	3937/2-4	490	546/150	431	625-20/	568	625-35/	569	629-1/2	460	661	452
3806/3	469	3938/4-6	490	546/170	431	PB1V12		PB2U25		629-1/4	460	66-1/10	434
3820	490	3939/6-9	490	546-1/10	431	625-20/PB1V15	568	625-35/	569	629-2/2	460	66-1/8	434
3825	490	3946/1-2	490	546-1/8	431	625-20/	568	PB2U32		629-2/4	460	663	430
3902	489	3947/2-4	490	546-1/9	431	PB1V18		625-40/	572	629-3/2	460	665/235	453
3902-3	489	3948/4-6	490	546-10	431	625-20/	568	PS2V42		629-3/4	460	666/1	442
392010	339	3949/6-9	490	546-20	431	PB1V22		625-40/	572	629-4/2	460	666/2	442
392012	339	4005	489	546-30	431	625-20/	568	PS2V54		629-4/4	460	670/170	441
392014	339	4070	489	546-40	431	PB1V35		625-43/	572	631	458	671/240	441
392016	339	4071	489	546-50	431	625-23/	568	PS2M42		631-10	459	672/265	438
392018	339	4073/10	489	546-60	431	PB1M12		625-44/	572	631-12	459	673/105	441
392020	339	4073/20	489	548/10	431	625-23/	568	PS2T40		631-13	459	673/86	441
392022	339	4080	488	548/12	431	PB1M15		625-44/	572	631-14	459	673-1/1	441
392024	339	4081	488	548/8	431	625-23/	568	PS2T50		631-2	458	673-1/2	441
392026	339	4082	488	548/9	431	PB1M18		625-44/	572	631-3	458	673-2/2	442
392028	339	4090	488	550/180	431	625-23/	568	PS2T63		631-4	458	674	438
392050	338	4091	488	551/500	431	PB1M22		625-45/	572	631-5	459	675	439
392052	338	4092	488	56/10x11	434	625-23/	568	PS2U40		631-52	459	676	453
392054	338	4200	485	56/10x13	434	PB1M28		625-45/	572	631-53	459	676-1	453
392056	338	4207	558	56/12x13	434	625-23/	568	PS2U63		631-54	459	677	452
392058	338	4210	558	56/14x15	434	PB1M35		625-4K0/	560	632-1	458	677-1	452
392060	338	4250	555	56/14x17	434	625-24/PB1T16	568	ECO203		632-11	458	682/250	429
392062	338	4255	554	56/16x17	434	625-24/	568	625-4PG/	560	633/35	459	685/175	428
392064	338	4258	554	56/17x19	434	PB1T20		ECO203		633/45	459	685/240	428
392066	338	4259	554	56/18x19	434	625-24/	568	625-4SE/	560	633-1	459	685/300	428
392070	338	4260	555	56/20x22	434	PB1T26		ECO203		633-2	458	687/150	428
392072	338	4261	555	56/21x23	434	625-24/	568	625-53/	573	633-3	459	687/180	428
392100	337	4262	555	56/22x24	434	PB1T32		PS3M08		633-4	458	687/250	428
392102	337	4263	555	56/24x27	434	625-24/PB1T40	568	625-53/	573	633-71/35	458	687/300	428
392104	337	4265	554	56/25x28	434	625-25/	568	PS3M42		633-75A	458	689/180	429
392106	337	4266	554	56/30x32	434	PB1U16		625-53/	573	633-76	458	689/240	429
392108	337	4278-1	554	56/36x41	434	625-25/	568	PS3M64		634/35	462	696/240	432
392110	337	4278-3	554	56/41x46	434	PB1U25		625-53/	573	634-1/35	462	7000/15	546
392112	337	4280	555	56/46x50	434	625-25/	568	PS3M76		635/35	463	7000/5	546
392114	337	4394	482	56/8x9	434	PB1U32		625-53/	573	635/42	463	701/10	464
392116	337	4395	482	58-1/10	434	625-25/	568	PS3M88		635-10/35	463	701/12	464
392118	337	4398	482	58-1/12	434	625-2K0/	560	625-5AK/	562	635-10/42	463	701/15	464
392120	337	4399	482	58-1/8	434	EF2P03		ACO203		636-1/10	464	701/16	464
392122	337	4405/5	479	618/1	428	625-2PG/	560	625-5K0/	562	636-1/12	464	701/8	464
392124	337	4405/7	479	618/11/2	428	EF2P03		ACO203		637	463	705/1/2	454
3922/1-2	490	4406	479	618/2	428	625-2SE/	560	625-5K0/	562	637-1/10	464	714/1	455
3923/2-4	490	4407	479	618/3	428	EF2P03		ACO203		637-1/12	464	714/2	455
3924/4-6	490	4408	479	618/4	428	625-30/	569	625-5LA/	562	637-1/14	464	715/2	455
3925/6-9	490	4426	478	619/1	428	PB2V15		ACO203		637-1/15	464	718/1	455
3926/9-14	490	4427	478	619/1/2	428	625-30/	569	625-5SE/	562	637-1/16	464	718/1/2	455
392800	316	4428	478	619/11/2	428	PB2V18		ACO203		637-1/17	464	718/3/4	455
392802	317	4429	478	619/2	428	625-30/	569	625-5XL/	563	637-1/18	464	718/3/8	455
392804	315	4429-1/5	478	619/3	428	PB2V22		ACO203		637-1/20	464	725	453
392806	316	4430	478	6200/115	518	625-30/	569	625-63/	573	637-1/22	464	7360	547
392810	317	4435/250	479	6200/125	518	PB2V28		PS4H08		637-1/26	464	7362	547
393000	310	4435/350	479	6200/178	518	625-30/	569	625-63/	573	637-1/32	464	7410	540
393002	310	4436/250	479	6200/230	518	PB2V35		PS4H76		637-10	463	7413	543
393004	310	4436/350	479	6215/115	518	625-30/	569	625-63/	573	637-20	464	7418	541
393006	310	4443	480	6215/125	518	PB2V42		PS4H88		637-6/1	464	7419	541
393008	310	4443-1	480	6215/150	518	625-30/	569	625-7K0/	565	637-6/2	464	7420/1	546
393010	310	4443-2	480	6215/230	518	PB2V54		PS323		637-6/3	464	7420/2	546
393012	310	4444	480	6219/125	518	625-33/	569	625-7K0/	565	637-6/4	464	7438	542
393016	203	4446	480	622/28	458	PB2M12		PS324		637-6/5	464	7515	548
393018	311	4447	481	622/63	460	625-33/	569	625-8AK/	564	638/15	462	7516	548
393020	311	4447-0	480	622-1	458	PB2M15		ACO403		64/10	434	7530	542
393022	311	4447-1	481	623/3/4-4	432	625-33/	569	625-8PG/	564	64/13	434	762/260	517
393024	311	4447-11	481	623-1/3/4-4	432	PB2M18		ACO403		64/17	434	7640	466
393026	311	4452/1,5	481	6240/115	518	625-33/	569	625-K0/PB1	565	64/19	434	7640-1	466
393028	312	4452/2	481	6240/125	518	PB2M22		625-K0/PB2	565	64/24	434	7640-2	466
393030	312	4452/3	481	6240/180	518	625-33/	569	625-K0/PS2	565	646	462	7641	467
393032	311	4452/5	481	6240/230	518	PB2M35		625-KO/ZBXL	565	647/63	462	7641-1	467
393034	310	49/250	435	625-1AK/	561	625-34/	569	625-ZB/221XL	573	648/35	462	786/260	517
393036	310	49/310	435	ACO103		PB2T16		625-ZB/222XL	573	648/54	462	790005	346
						625-34/	569	625-ZB/SETXL	573				
						PB2T20							

Index

Art. no.	page	Art. no.	page	Art. no.	page	Art. no.	page
790006	346	790454	347	792821	349	905/25,5	500
790008	346	790456	347	793/250	517	905/32,5	500
790015	346	790470	347	793005	346	905/40,5	500
790016	346	790500	347	793006	346	905/50,5	500
790017	346	790502	347	793007	346	905/63,5	500
790018	346	790504	347	793008	346	910/11/4	499
790027	346	790510	347	793027	346	910/11/8	499
790029	346	790512	347	793029	346	912/15	499
790030	346	790514	347	793030	346	912/16	499
790031	346	790516	347	793031	346	912/17	499
790040	346	790540	347	793040	346	912/18	499
790041	346	790542	347	793041	346	912/19	499
790043	346	790544	347	793043	346	912/20	499
790051	346	790562	347	793051	346	912/21	499
790053	346	790564	347	793053	346	912/22	499
790054	346	790566	347	793054	346	912/23	499
790055	346	790588	347	793055	346	912/24	499
790056	346	790592	347	793064	346	912/25	499
790063	346	790616	347	793065	346	912/26	499
790064	346	790618	347	793099	346	912/27	499
790065	346	790700	347	793100	346	912/28	499
790079	346	790702	347	793101	346	912/30	499
790090	346	790704	347	793102	346	912/31	499
790091	346	790706	347	793103	346	912/33	499
790093	346	790710	347	793104	346	912/34	499
790100	346	790712	347	793111	346	912/36	499
790101	346	790714	347	793112	346	912/38	499
790102	346	790716	347	793113	346	912/39	499
790103	346	790721	347	793118	346	912/40	499
790104	346	790722	347	793120	346	912/41	499
790111	346	790724	347	793121	346	912/42	499
790112	346	790726	347	793125	346	912/43	499
790113	346	790806	347	794/250	517	912/44	499
790118	346	790808	347	794002	351	912/45	499
790120	346	790832	347	794004	351	912/46	499
790121	346	790834	347	794012	351	912/48	499
790210	346	790837	347	794014	351	912/49	499
790211	346	790862	347	794016	351	912/50	499
790212	346	790864	347	794018	351	912/51	499
790212/V	346	790867	347	794020	351	912/52	499
790222	346	790882	347	794022	351	912/53	499
790223	346	790884	347	794024	351	912/55	499
790223/V	346	790888	347	794026	351	913/10x1	500
790224	346	790900	346	794028	351	913/12x1,5	500
790224/V	346	790902	346	794030	351	913/16x1,5	500
790225	346	790920	346	794040	351	92/10x11	440
790235	346	790922	346	794050	352	92/12x13	440
790235/V	346	792/250	517	794052	352	92/14x15	440
790236	346	792000	348	794060	352	92/17x19	440
790237	346	792001	348	794062	352	92/19x22	440
790303	347	792002	348	794070	352	92/20x22	440
790311	347	792003	348	798/300	517	92/22x24	440
790325	347	792005	348	8030/1,0	485	92/24x27	440
790326	347	792006	348	8030/1,5	485	92/30x32	440
790327	347	792008	348	8061/1,0	485	92/32x36	440
790329	347	792600	348	8061/1,5	485	92/6x7	440
790332	347	792602	348	8080	484	92/8x9	440
790333	347	792603	348	81-1/10	434	92-1	440
790334	347	792604	348	83	95	94/10	440
790335	347	792606	348	90/10	440	94/13	440
790411	347	792607	348	90/11	440	94/17	440
790413	347	792650	348	90/12	440	94/19	440
790416	347	792651	348	90/13	440	94/22	440
790417	347	792652	348	90/9	440	94/36	440
790419	347	792654	348	900/11	499	94/10	440
790422	347	792656	348	900/13,5	499	94/13	440
790423	347	792658	348	900/16	499	94/17	440
790424	347	792756	348	900/21	499	94/19	440
790426	347	792758	348	900/29	499	94/22	440
790428	347	792760	348	900/36	499	94/36	440
790432	347	792762	348	900/42	499		
790433	347	792802	348	900/48	499		
790434	347	792804	348	900/9	499		
790436	347	792806	349	9001	428		
790450	347	792810	349	905/16,5	500		
790452	347	792816	349	905/20,5	500		

Index

Connection set basic module „CableGo“	103	Cutting tool	88	Electrician's safety levels	240
Connection shackle for probes Ø 6 mm	94	Cutting tool for lamellar rails	88	Electricians' chisels	320
Connection sleeve for probes Ø 3 mm	92	Cutting wheel Copper, brass	458	Electricians' screwdrivers „HUPslim“ 1000 V Slot	207
Connection sleeve for probes Ø 4.5 mm	93	Cutting wheel Plastic	459, 460	Electricians' screwdrivers Slot	209, 260, 261
Connection sleeve for probes Ø 9 + 11 mm	95, 97	Cutting wheel stainless steel, carbon steel	458	Electro-hydraulic pump „PN700 I“	80
Connection sleeve with rotator	95	Cutting wheel stainless steel, carbon steel, copper	458	Electro-hydraulic pump „Special“	88
Construction foil „Profi“	312	Cutting wheel Stainless steel, copper, brass	458	Electronic screwing bit set	267
Construction Glue HUPfix+	410	Cutting wheel Steel	460	EMC-Cable glands brass nickel-plated	193
Contact files	322	Cutting-Oil HUPdrill	416	Empty dispenser box	115
Contact spray HUPwetBlock	416			End connectors	130
Content manometer	488			End sleeve assortment - serie DIN	116, 117
Control station	472	D	page	End sleeves	108, 109
Converting bit for bleeding	286	Deburrer Pipe cutter with deburrer	458	End sleeves colour range III, DIN „SmallPack“	114
Copper piece	479	Decoiler 1200	100	End sleeves for short-circuit-proof cables	113
Copper pipe bending pliers	464	Decoiler 1200 +	100	End sleeves in tape form, to DIN 46228 P. 4	111
Copper pipe bending springs	464	Decoiler 600	100	End sleeves, colour range I, (french)	110, 112
Cord und cable grips	98	Deep hole marker	307	End sleeves, colour range II, (german)	110, 112
Cordless Pressing Tool ACO103 BT 4.0 Ah	561	DIAMOND Core bit	498	Engineer's file flat	521
Cordless Pressing Tool ACO203 BT 5.0 Ah	562	DIAMOND core drills „BRdiamondDrill“	494, 497	Engineer's file half round	521
Cordless Pressing Tool ACO203XL BT 5.0 Ah	563	DIAMOND core drills set	495, 496, 497, 498	Engineer's file round	521
Cordless Pressing Tool ACO403 BT 5.0 Ah	564	Diamond cutting and chamfering disc	518	Engineers' hammer	321
Cordless Pressing Tool Set ACO102 4.0 Ah	562	Diamond cutting blades	336	Engineers' screwdrivers Slot	260, 261, 446
Cordless Pressing Tool Set ACO203 4.0 Ah	562	Diamond cutting blades, TBM Turbo	336	Engineers' squares	307
Corner pipe pliers	428	Diamond cutting disc	518	Engineers' squares	307
Corner pipe pliers	428	Diamond cutting disk „Spezial“	336	Engraving for sealing pliers	257
Cotton gloves for putting underneath	249	Diamond hollow core cutter special	335	ESD Electronic combination pliers	294
Counter hold spanners 1000 V	226, 240	Diamond hollow core cutters	335	ESD Electronic flat nose pliers	294
Countersunk nail dowel	351	DIAMOND tile drill	498	ESD Electronic front cutter	294
Covering blankets transparent	255	Dies	47, 48, 54, 55, 56, 72, 73	ESD Electronic needle nose pliers	293
Cowhide & ABS tool case „Plumbing EXCLUSIVE“	547	Dies for C-connectors	68	ESD Electronic needle nose pliers, 45° angle	293
Cranking tool for stepped bending of power rails	88	Dies for compacted connectors	72	ESD Electronic pliers set	294
Crimp ring terminals without insulation DIN 46234	147	Dies for connectors with notch	68	ESD Electronic round nose pliers	294
Crimping dies DIN	63, 72	Dies for elektro crimper 217050	53	ESD electronic screwdriver set	266
Crimping dies DIN Cu + Al	64	Dies for indent crimping for compacted cables	68	ESD electronic screwdrivers	266
Crimping dies DIN for Copper and Aluminium	72	Dies for rounding of round conductors	67	ESD Electronic side cutter	294
Crimping dies DIN for DIN Aluminium terminals	68, 72	Dies for sealing pliers	257	ESD Electronic side cutter without cutting-facet	294
Crimping dies DIN-connection, Cu/Al	79	Dies for standard aluminium pipe cable lugs	68	ESD Electronic thin needle nose pliers	293
Crimping dies for cable class 5+6, F-Type	73	Dies for terminals and compacted connectors	67	ESD Electronic thin needle nose pliers, 45° angle	293
Crimping dies for cable lugs / end sleeves	52	Dies for terminals and connectors DIN	67	Exchangeable Vario 1000 V handle	212
Crimping dies for C-connectors	73	Dies for terminals and connectors standard	67	Exchangeable VarioTQ 1000 V handle	216
Crimping dies for coaxial cable	52	Dies, metric thread	342	Exchangeable VarioTQ handle	265
Crimping dies for end sleeves	52, 67	Dispenser box with insulated end sleeves (DIN)	115	Expansion dowel sleeve	351
Crimping dies for end sleeves	73	Dispenser box with insulated end sleeves (french)	115	Explosion protection safeguard	489
Crimping dies for flat connectors	52	Dispenser box with insulated end sleeves (german)	115	Express wrench M10	278
Crimping dies for insulated crimp cable lugs	52	Dispenser box with Twin end sleeves (DIN)	115	Extension	440
Crimping dies for insulated tube terminals	73	Dispenser box with uninsulated end sleeves	115	Extension bendy	439
Crimping dies for Photovoltaik	52	Dispenser for hand cleaning cream HUPsoap, 3l	413	Extension 1/2“	281
Crimping dies for Photovoltaik MC4	52	Dollies	464	Extension 1/4“	278
Crimping dies for rounding of square connectors	73	Dosage cap „Target Control System“	418	Extension 3/8“	280
Crimping dies for standard Al terminals and connectors	72	Double edged cable cutter 1000 V	222	Extension with bit adapter 1000 V	230, 234, 238
Crimping dies for TWIN end sleeves	52	Double ended ring spanner sets DIN 838	276	Extensions 1000 V	230, 234, 238
Crimping dies for uninsulated terminals	52	Double ended ring spanners to DIN 838	276	Extensions VDE	228, 232, 236
Crimping dies set DIN Aluminium	66	Double ended spanners acc. to DIN 3110	276		
Crimping dies set DIN Cu	66	Double ended spanners set acc. to DIN 3110	276	F	page
Crimping dies set Standard Aluminium	66	Double oxygenacetylene hose	72	Fallstop acc. to EN 354	254
Crimping dies set Standard Cu	66	Double-ended drill bit	493	Fast degreaser HUPdegreaser	416
Crimping dies standard	63	Double-locking-cable ties	179	Feeler gauge	532
Crimping dies standard copper tube terminals	72	Double-Sided Acryl Tape HUPtapeDouble	419	Fibre glass push rod set	91
Crimping dies standard copper tube terminals	72	Dowel Mounting sockets/Christmas trees	181	File assortments	322
Crimping dies, standard, Cu	79	Drill for Diamond hollow core cutters	335	File rasp	521
Crimping headstock „HKD400“	66	DRY construction marker	528	Fine droplet tip	412
Crimping headstock „KD300-6“	75	DRY leads Basic	528	Firmer chisels DIN 5139	320
Crimping headstock „KH-12“	71	DRY leads Graphite	528	Fitting brush	520
Crimping headstock „KO-6“	66	DRY leads Special	529	Fittings for hexagon socket screws VDE	228, 232, 236
Crimping headstock „U-D300-6“	62	DRY Profi	528	Fittings pliers Key pliers	429
Crimping headstock „U-D400-6“	62	DRY Profi LED	528	Fittings' solder acc. to DIN EN 29453	424
Crimping headstock „U-KDE240-6“	61	Dry wall screws	346	Flame protection mat	484
Crimping headstock „U-KO-6“	61	Dummy plugs	191	Flame retardant cable ties	178
Crimping pliers	38, 39, 42, 43, 44, 45	Dust masks	252	Flat bits	331
Crimping pliers „HUPsquare 10“	39	Dust protection door, multi-fleece	311	Flat brush	533
Crimping pliers „HUPsquare 16“	39			Flat cable pliers	29
Crimping pliers „HUPstar“	50			Flat chisel SDS Plus	525
Crimping pliers „Multi“	53	E	page	Flat chisels to DIN 6453 A, flat oval shank	320
Crimping pliers Combi-Crimp	52	Ear defenders acc. to EN 352	252	Flat nose pliers 1000 V	218
Crimping pliers for modular plugs	47, 48	Ear muffs	558	Flat terminals	123, 129, 132, 135, 141, 143
Crimping pliers for twin end sleeves	38	Ear muffs for helmet	252	Flat terminals „ECO-Line“	134
Crimping pliers HUPstar Coax	43	Ear plugs	558	Flat terminals „SmallPack“	126, 144
Crimping pliers HUPstar Photovoltaik	37	Ear protection plugs	252	Flatcable stripper	25
Crimping pliers X-Crimp	52	Edge cutter	34	FlexBag	274
Crimpset „MULTI Photovoltaik“	37	Elastic cable distributors	143	FlexBagPro	274
Crimpset X-Crimp for Photovoltaics	52	Electrical connectors with socket sleeves (male)	143	Flexible extension bar 1/4“	279
Crimpset X-Crimp including nylon bag	52	Electrical insulating tape „HUPtape-15“	202	Foam Cleaner HUPclean	417
Cross peen hammer	524	Electric-Engine-Cleaner HUPelectroClean	416	Foam insert SysCon	405
Cross slotted screwdrivers „HUPslim“	207	Electricians' boots acc. to EN 50321 Class 0	252	Folding pliers	430
Cross slotted screwdrivers Phillips	210, 260, 261	Electricians' protection helmets acc. to DIN EN 397	251	Folding rules	306
Cross slotted screwdrivers Pozidriv	210, 260, 261	Electricians' protection visor acc. to EN 166	251	Folding tool boards	546
Cross type socket wrenches 1000 V	226	Electricians' safety face mask class II	251	Fork terminals „ECO-Line“	133
Cupal washer	168			Fork terminals DIN 46237	121, 127, 131
Cut-off disk INOX	518			Fork terminals DIN 46237 „SmallPack“	125
Cut-off disk Steel	518			Fork terminals without insulation	149
Cut-protection gloves	551				
Cutting headstock „U-KS6-S50“	61				

	page				
Sabre saw blade CAST CHAMPION	514	Shank for hollow core cutters, SDS-Plus	335	Square socket key	216
Sabre saw blade CAST PROFI	514	Shaped punching scissors	517	Stainless steel, copper, brass	460
Sabre saw blade HM CAST SPECIAL	513	Sharp chisel SDS-Plus	525	Stainless-Steel-Spray HUPInox	415
Sabre saw blade INOX Profi	512	Sharpener	529	Stand for "HUPlight50combi"	302
Sabre saw blade Metal	512	Sheet metal punch	499	STANDARD camera cable	472
Sabre saw blade Universal SHARK	513	Sheet metal punch Electric	499, 500	STANDARD camera head	472
Sabre saw blade Wood	514	Sheet metal punch Plumbing	499	Steel cable ties, SS 316 (V4A) with ball closure	184
Sabre saw blades (U-shank)	514	Short flat nose pliers DIN ISO 5745 1000 V	221	Steel cable ties, SS 316 (V4A) with ratchet function	184
Sabre saw blades Metal DEMOLITION	512	Short flat nose pliers VDE	218, 219	Steel fish tapes	90
Sabre saw blades Metal POWER CURVE	512	Short round nose pliers VDE	218, 219	Steel mirror	485
Sabre saw blades Metal TWIN-CUT	513	Side cutters DIN ISO 5749	290	Steel point scribers	307
Sabre saw blades Universal MEGASHARP	513	Side cutters DIN ISO 5749 1000 V	221	Steel stamp, figures (0 - 9) DIN 1451	322
Safety belts acc. EN 358	254	Side cutters DIN ISO 5749 VDE	217, 219	Steel stamp, letters (A - Z), DIN 1451	322
Safety classes acc. to EN 166	252	Side cutting pliers with stripping function 1000 V	217	Step drills /HSS	333
Safety fuse grips	249	Silicone-Spray HUPsil	415	Step drills assortment/HSS	333
Safety glasses	554	Single ended spanners 1000 V	226	Step wrench	442
Safety harness DIN EN 361	254	Single ended tool set acc. to VDE 1000 V	227	Step wrench for gas	441
Safety knife „Safety“	325	Siphon	558	Step wrench for gas and water	442
Safety voltage tester 1000 V	447	Siphon pliers	430	Step wrench for radiator	441
Safety-sets VDE/GS	253	Sledge hammer to DIN 6475	321	Step wrench for radiator and water	441
Saw blade Metal	507	Sleeve extractor	436	Step wrench set	438, 439
Saw blade Universal	507	Sleeve extractor set	436	Stone chisels, flat oval shank	320
Saw blade Wood	507	Sleeves for round compacted conductors DIN	162	Stone chisels, octagonal shank	320
Schaffner control pliers	431	Slide Box with DIN end sleeves	116	Straight cutting scissors	517
S-connection assembly set	453	Slide Box with DIN TWIN end sleeves	116	Street broom	310
S-connection assembly tool	453	Sliding adapter 1/2" x 3/8"	280	Stripper „All-rounder“	25
Screw extractor set	342	Sliding adapter 3/8" x 1/2"	281	Stripper for coaxial cable	26
Screw punches	334	Sliding adapter 3/8" x 1/4"	279	Stripper for UTP-/STP-data cable	26
Screw remover	500	SlimTop - cable glands IP 68, metric or PG	90, 191	Stripping plier 1000 V	224
Screw remover set	500	Slip on bushes 1000 V	256	Stripping pliers	34
Screw type sockets	181	SMALL camera cable	474	Stripping tool for medium-high voltage cable	34
Screwdriver	446	SMALL camera head	473	Stubby gasifier cross slot screwdrivers Phillips	262
Screwdriver PH	446	SMALL camera head set	473	Stubby gasifier screwdrivers	262
Screwdriver PZ	446	Small tube cutter	326	Switch cabinet key, „HUPkey“	286
Screwdriver „HUPslim“ 1000 V with PZ slot profile	206	Smart Battery powered crimping tool „US-6M“	61	Switch cabinet key, „HUPkey“ with converting bit	286
Screwdriver 1000 V	447	Smoke-Detector-Test-Spray HUPdetect	420	SWIVEL-MOUNTED camera cable	475
Screwdriver 1000 V PH	447	Snap blades	325	SWIVEL-MOUNTED camera head	474
Screwdriver 1000 V PZ	447	Socket cup screw DIN 84 Form A	347	SWIVEL-MOUNTED camera head set	474
Screwdriver bits	270, 271	Socket sleeves (female)	122, 128, 131, 135, 140	SysCon „SocketMax“ 1/2", 1/4"	282
Screwdriver bits Tx	271	Socket sleeves (female) „ECO-Line“	133	SysCon cable lugs DIN & 210805 K	172
Screwdriver bits, reduced	270	Socket sleeves (female) „SmallPack“	126, 144	SysCon cable lugs DIN 46235	173
Screwdriver set	262, 446	Socket sleeves (female) „SmallPack“ with branch	144	SysCon cable lugs standard	173
Screwdriver set „HUPslim“ PZ	206	Socket sleeves (female) with branch	123, 129, 141	SysCon cable lugs standard & 210805	172
Screwdriver set Tx	261	Socket sleeves (female), fully-insulated	123, 129, 132	SysCon cable pulling device „CableGo master“	103
Screwdriver set with PZ slot profile	209	Socket sleeves (female), fully-insulated „ECO-Line“	134	SysCon cable pulling device „CableGo profi“	103
Screwdriver set with striking cap	448	Socket sleeves (male) DIN 46231	121, 127	SysCon cable pulling device „CableGo starter“	103
Screwdriver with PZ slot profile	209	Socket sleeves (male) with latching tongue	142	SysCon end sleeves & 210804	118
Screwdrivers set „HUPslim“ 1000 V	207	Socket T-wrench 1000 V	230, 234, 238	SysCon end sleeves & 210842	118
Screwdrivers set 1000 V	210, 447	Socket T-wrench VDE	228, 232, 236	SysCon for assortment inserts empty	403
Screwdrivers Square	210, 261	Socket wrench box „SocketFlex“	283	SysCon hand truck	406
Screwdrivers Tx	210, 261	Socket wrench set „BRImultiLock“ 55 pieces	437	SysCon insulated terminals & 210761	138
Screw-Locking High-Strength HUPlockH	413	Socket wrench set „BRImultiLock“ 87 pieces	437	SysCon insulated terminals / end sleeves & 210784	138
Screw-Locking Medium-Strength HUPlockM	413	Socket wrenches	263, 440	SysCon load securing „SysConCar“	406
Screws and dowel assortment box „Mix“	349	Socket wrenches DIN 7445	211	SysCon M for assortment inserts empty	403
Screws assortment box „Countersunk“	349	Socket wrenches set	263, 278, 280, 281, 282, 440	SysCon plate screws	350
Screws assortment box „Mix Tx“	349	Socket wrenches set DIN 7445	211	SysCon S „VDE-Socket“ 1/2"	237
Screws assortment box „Mix“	348	Sockets 1/2"	281	SysCon socket wrench set „Torque“ ¼"	285
Screws assortment box „Pan head“	348	Sockets 1/4"	279	SysCon socket wrench set „Torque“ ½"	285
SDS chuck adaptor with drill	503	Sockets 3/8"	280	SysCon tool box empty	403, 404
SDS hammer drill bits	332	Soft solder insert	478, 479	SysCon tool case set	407
SDS magnetic holder	271	Solder	485	SysCon tool case set „Start VDE“	407
SDS-hammer drill sets	332	Solder for electronic work acc. to DIN EN 29453	424	SysCon transport system	402
SDS-Nut-hammer drill sets	332	Solder in triangular sticks DIN 1707	423	SysCon universal countersunk screws	350
SDS-shank	339	Solder water bottle	486	SysCon XL „SafetySet“	253
Seal wire	257, 431	Solder water brush	485		
Sealing balloon	468	Solder wire	485		
Sealing cap	480	Solder wire according to Din EN 29453	424		
Sealing pliers	257, 431	Soldering fluid acc. to DIN 8511-F-SW 32	423		
Sealing stamp	431	Soldering fluid acc. to DIN 8511-F-W 21	423		
Security bag, empty	253	Soldering grease	423	T.C.T. center drill for hole saw arbors	337
Self adhesive PVC tape	256	Soldering irons	422	T.C.T. hammer drill	493
Self adhesive sockets	181	Soldering paste acc. to DIN 8511-F-SW 26	423	T.C.T. hammer drill	493
Self-welding insulation tape „HUPtape76seal“	203	Soldering stone	423	T.C.T. Hole Saw	337
Sensor Tool LSA	26	Soldering torch	478	T.C.T. Hole Saw Fastcut	337
Servcie bag	548	Solderless butt connector	150	T.C.T. stone drill	492
Service bag „HUPsmartHome“	367	Solderless terminals for meter connection	148	Table clamp „CableGo“	103
Service bag „Plumbing CLASSIC“	548	Spacer bushing	86	Tackle blocks	258
Service bag „Supply Basic“ service bag	369	Spade chisel SDS Plus	525	Tap extension wrench	443
Service bag „Supply Max“ service bag	368	Spanners for switch cabinet key, „HUPkey Uni“	287	Tap reseating tool	455
Service bag „Supply Plus“ service bag	368	Spanners for switch-cabinets, „HUPkey“	287	Taps for armoured steel conduits, metric thread	342
Service bag „Supply“	357	Spare cutting head	224	Tarpaulin premium	311
Service set for HAUPA-FIBRE	92	Spare screws	334	Tarpaulin, strong	311
Service trolley for hybrid vehicles 1000 V	386	Spark plug sockets 1/2"	281	T-connectors, standard series	156
Set 3 wire brackets „CableGo“	103	Spark plug sockets 3/8"	280	Template for four mandrel pressing	76
Set HUPshrink21TW thin-walled 2:1	196	Special cable cutter	12	Tensioning tools for cable ties	181
Set HUPshrink31DW-A double-walled 3:1	196	Special fast glue for glass fibre rod Ø 3 mm	92	Tensioning tools for steel cable ties	184
Set of cone drills/HSS	334	Special pulling aid	92	Test pin	76
Set of numbers	530	Spinner handle for screwdriver 1/4"	279	Textile tape	203
Set with protective gloves EN 60903	249	Spiral fish tapes	90	T-handle allen keys 1000 V	226
Set with protective gloves EN 60903 light	249	Spring for hole saw arbors	337	T-Handle socket wrenches 1000 V	226
		Spring toggle	352	The ideal tool assortment	391
		Spring washers	348	Tile kit	503
				Tongue trowel	534

Tool belt	355	Tubular cable lugs assortment DIN 46235	171	Water pressure drain cleaner	468
Tool belt "Basic"	359	Tubular cable lugs assortment standard	171	Water pump pliers	428
Tool belt "VDE Plus" 1000 V	359	Tubular cable lugs for fine-wired	158	Water pump pliers automatic	429
Tool belt "VDE" 1000 V	359	Tubular cable lugs of pure nickel, ring type	164	Water pump pliers DIN ISO 8976	291
Tool case "Akkurat"	390	Tubular cable lugs, standard series	153, 154	Water pump pliers DIN ISO 8976 1000 V	220
Tool case "Aktion"	377	Tubular terminals of pure nickel, forke type	164	Water pump pliers DIN ISO 8976 VDE	218
Tool case "Alpha"	373	Tubular terminals, Light "T" series	151, 152	Water-based lubricants and slip agents	413
Tool case "Basic VDE"	389	Tubularcable lugs, nylon-insulated, standard series	157	WC seat installation wrench	452
Tool case "Basic"	389	Turning tool	441	Welded shrink connector, transparent	136
Tool case "BRlactive"	541	Tweezers	292	Welded shrink connectors	136
Tool case "Comet"	370	Twelve-point ring wrench set	434	Welder's goggles	555
Tool case "Compact"	388	Twin-end sleeves two cables DIN	113, 114	Welder's tightly fitting safety goggles	555
Tool case "Delux Plus" 1000 V	393	Twin-end sleeves two cables DIN "SmallPack"	114	Welding insert	490
Tool case "Delux" 1000 V	374	Twin-end sleeves, colour series II (German)	114	Werkzeug-Trolley „Master Mobil“ 1000 V"	385
Tool case "Diamant"	391	TwinSpeed self tapping screw	347	Wheel bolt Combination pipe cutter	460
Tool case "EXTRA"	382	Twist drill	492	Wheel bolt Mini pipe cutter	458
Tool case "Favorit - Admiral - Profi"	370	Twist drill set	492	Wheel bolt Miniature pipe cutter	459
Tool case "HAUPA - Lifesaver" 1000 V	395	Twist drills DIN 338/HSS type N	330	Wheel bolt Pipe cutter	460
Tool case "Inspektor"	390	Twist drills DIN 338/HSS type N	330	Wheel bolt Pipe cutter with deburrer	458
Tool case "Jobstarter Plus"	380	TX-Screwdriver-Set	448	Wheel bolts Compact pipe cutter	459
Tool case "Leopard" 1000 V	393			Wheel ratchet for bits	450
Tool case "Magister"	371			Wind protection	478
Tool case "Nouvelle 1"	372			Wire brush	520
Tool case "Omega"	377			Wire brushes	312
Tool case "OmegaMax Start VDE"	392	U	page	Wire cutter	10
Tool case "Panther"	388	Universal alignment tool for sector conductor	240	Wire Grips Aluminium	537
Tool case "Pendant"	378	Universal bow saw	506	Wire Grips Copper and Steel	537
Tool case "Phoenix"	371	Universal bow saw fold-down	506	Wire Grips Insulated	536
Tool case "Plumbing CLASSIC"	541	Universal cable cutter with eccentric drive	14	Wire Grips Universal	536
Tool case "Plumbing EXCLUSIVE"	542	Universal countersunk screw	346	Wire rope and cable cutter 1000 V	224
Tool case "Plumbing Swimming pool EXCLUSIVE"	542	Universal joint 1/2"	281	Wire stretcher	538
Tool case "plumbing"	540	Universal joint 1/4"	279	Wire stripper / Solar	29
Tool case "Power Pack" 1000 V	394	Universal joint 3/8"	280	Wire stripper „High Strip“	28
Tool case "Profi VDE" 1000 V	383	Universal metal dowel	352	Wire stripper Sensor Mini	30
Tool case "Rotor" 1000 V	375	Universal pan head screw	346	Wire stripper sensor special	30
Tool case "Saphir"	372	Universal set 1	62	Wire stripping pliers	291
Tool case "Start VDE"	374	Universal set 2	62	Wire stripping pliers 1000 V	221
Tool case "Start"	373	Universal stripper	25	Wire stripping pliers VDE	217, 220
Tool case "Start-up Go"	380	Universal-Lubricant HUP40	415	Wood rasp	521
Tool case "Start-up Light"	379	Utility knife	326, 516	Work gloves	550
Tool case "Start-up Max"	381	Utility knives „EXTRA“ with spare blades	325	Work gloves	550
Tool case "Start-up Profi"	376	Utility metal knives	325	Working manometer	488
Tool case "Start-up S"	376				
Tool case "Start-up Sanitär"	397	V	page	Z	page
Tool case "Start-up SHK"	397	Valve extension cutter with chip collection	454	Zinc spray 550 HUPzincKorro	414
Tool case "Start-up VDE"	382	Valve holder	453	Zinc-Spray HUPzinc	414
Tool case "Start-up"	381	Vario replaceable blade - Phillips blade	212		
Tool case "Tradition" and "Fan"	370	Vario replaceable blade - pozidrive blade	212		
Tool case "Venus Plus" 1000 V	394	Vario replaceable blade - pozidrive blade/slotted	212		
Tool case „Biber“ 1000 V	239	Vario replaceable blade - slotted blade	212		
Tool case „ElektroCombo“	213	Vario replaceable blade - torx blade	212		
Tool case „Real“ 1000 V	220	Vario S2	263		
Tool case 1000 V	235	Vario screw cap	212		
Tool case 1000 V	235, 239	Vario switch cabinet key - Double-bit	212		
Tool case 1000 V	231	Vario switch cabinet key - Square	212		
Tool case for household connections 1000 V	231	Vario switch cabinet key - Triangular	212		
Tool case trolley "Extreme"	378	VarioPro 1000 V replaceable blade system	213		
Tool case trolley „Extreme“ 1000 V	396	VarioTQ	264		
Tool case trolley "EXTRA"	385	VarioTQ 1000 V replaceable blade - hex blade	216		
Tool case trolley "Fly"	377	VarioTQ 1000 V replaceable blade - Phillips blade	216		
Tool case trolley "Master"	384	VarioTQ 1000 V replaceable blade - pozidrive blade	216		
Tool case trolley "OmegaMax Trolley Start VDE"	392	VarioTQ 1000 V replaceable blade - PZ/FL	216		
Tool case trolley "OmegaMax Trolley"	377	VarioTQ 1000 V replaceable blade - slotted blade	216		
Tool case trolley "Profi mobil"	383	VarioTQ 1000 V replaceable blade - torx blade	216		
Tool case trolley "Secure mobil" 1000 V	386	VDE magnet for rubber cloth	255		
Tool case trolley "Start-up Profi"	376	VDE security set 1000 V	370		
Tool case trolley "Start-up"	384	VDE/GS - Tool sets 1000 V	370		
Tool case VDE 1/2"	236	VDE/GS - Tool wallets "Rebell"	358		
Tool case VDE 1/4"	228	Voltage tester 120-250 V	270		
Tool case VDE 3/8"	232	Voltage tester 120-250 V	270		
Tool cases	88	Voltage tester 120-250 V	270		
Tool frame „HUPstar“ - closed	50	Voltage tester	270		
Tool frame „HUPstar“ - open	50	Voltage tester "Basic +"	245		
Tool holder for construction buckets	358	Voltage tester "Profi LCDplus II"	244		
Tool plate	404	Voltage tester "Profi LEDplus II"	244		
Tool plate SysCon	404	Voltage tester "TestPen Profi"	246		
Tool trolley "Skater"	543	Voltage tester set 1000 V	448		
Tool wallets	358, 546	Voltage tester VDE/GS	246		
Tools insert SysCon	405				
Tools insert SysCon	405	W	page		
Top Coax Plus cable stripper	25	Warning sign, plastic „Caution, Wet floor“, yellow	312		
Torch brazing set SolderingKit	200	Washbasin tap wrench	453		
Torque stoppers 1000 V	234	Washbasin tap wrench insert	452		
Torque T key 1000 V	234	Washbasin tap wrench inserts Claw	452		
Torque wrench	439	Washers	348		
Torque wrenches	284, 285	Washers DIN 125	348		
Torque wrenches 1000 V	230, 232, 234, 238	Waste sack, extra	311		
Travelling safety device DIN 353-2, Type ASK 1	254	Water brushes	312, 533		
Triangular socket wrench	441				
Trowel	313, 534				
Trowel „Profi“	313				
Tube cutter	326				

**HAUPA transparent /
Foreign representatives**

HAUPA-Group

Germany (HAUPA Main Office)

HAUPA GmbH & Co. KG

Königstraße 165-169

D-42853 Remscheid

Phone: +49 (0) 2191 8418 0

Fax: +49 (0) 2191 8418 840

E-Mail: sales@haupa.com, info@haupa.com

Internet: www.haupa.com

Austria

HAUPA Werkzeuge Hans-Udo Paas

Bayernstraße 39

A-5071 Wals-Siezenheim

Tel.: +43 (0662) 854717

Fax: +43 (0662) 854632

E-Mail: austria@haupa.com

Spain

HAUPA Ibérica S. L.

C/ Muralla de Sant Llorenç, 37 2^ªA

08302 Mataró (Barcelona)

Phone: +34 93-63-82-111

Fax: +34 93-66-21-686

E-Mail: comercial@haupa.es

Poland

HAUPA Polska Sp. z o.o.

ul. Norwida 11

55100 Trzebnica

Phone: +48 (0)71 387 48 13

Fax: +48 (0)71 387 48 14

E-Mail: haupa@haupa.pl

Russia

HAUPA-RU Ltd

ul. Industrialnaya 9/1

180021 Pskov, RUSSIA

Phone: +7 (495) 133-62-24

E-Mail: russia@haupa.com

www.haupa-ru.ru

Baltic States

UAB HAUPA Baltics

Žirmūnų g. 139 - 318

09120 Vilnius

GSM: +370 699 633 63

E-Mail: andrius.krisiunas@haupa.com

www.haupa.com

Balkan States

HAUPA S.E.E. d.o.o.

Miroslava Krleža 24

71000 Sarajevo

Phone/Fax: +387(0)33545725

GSM: +38763891678

E-Mail: goran.hrgovic@haupa.com

Romania

SC HAUPA SRL

Str. G. Enescu, Nr. 3

331030 Hunedoara

GSM: +4 0744 561 567

Fax: +4 0354 407 994

E-Mail: mihai.lupu@haupa.com

Serbia

ICON by HAUPA d.o.o.

Miše Dimitrijevića 44

21000 Novi Sad

GSM: +381 21 300-2937

E-Mail: info@iconbyhaupa.rs

Commercial sales staff, Germany

Hans-Joachim Gummersbach (HAUPA Main Office)

HAUPA GmbH & Co. KG

Königstraße 165-169

D-42853 Remscheid

Phone: +49 (0) 2191 8418 0

Fax: +49 (0) 2191 8418 840

E-Mail: joachim.gummersbach@haupa.com

Rainer Eiselt

Industrievertretungen

Südstraße 4

09221 Neukirchen

Phone: +49 (0) 371 271050

Fax: +49 (0) 371 2710518

E-Mail: info@iv-eiselt.de

Sachsen/Sachsen-Anhalt/Thüringen

Martin Hellmund

IV Krause GmbH

Schneeberger Straße 17

12627 Berlin

E-Mail: info@iv-krause.de

Web: www.iv-krause.de

Tel.: +49 (30) 39806352

Berlin/Brandenburg

Christian Binz

Technischer Berater im Außendienst

Königstraße 165-169

D-42853 Remscheid

Phone: +49 (0) 2191 8418 210

Fax: +49 (0) 2191 8418 840

Mobil: +49 (0) 173 76 28 445

E-Mail: christian.binz@haupa.com

Hamburg/Schweswig-Holstein/

Mecklenburg-Vorpommern

Markus Hermann

Technischer Berater im Außendienst

Königstraße 165-169

D-42853 Remscheid

Phone: +49 (0) 2191 8418 210

Fax: +49 (0) 2191 8418 840

GSM: +49 (0) 160 972 624 95

E-Mail: markus.hermann@haupa.com

NRW-Ost/Niedersachsen/Hannover/Bremen

Sönnecken GmbH

Industrie-Vertretungen

Wildermannstr. 8

44141 Dortmund

Phone: +49 (0) 231 5600012

Fax: +49 (0) 231 590607

E-Mail: soenneckengmbh@t-online.de

NRW Ruhrgebiet

Carsten Potrz

Industrievertretung

Hausinger Straße 8

40764 Langenfeld

Phone: +49 (0) 2173/1657923

Fax: +49 (0) 2173/1657926

Mobile Phone: 0170/8114074

E-Mail: potrz@cpiv.de

Web: www.cpip.de

NRW Rheinland

Außenbüro NRW Rheinland

Karl Kleemann

Industrievertretung

Löhndorfer Str. 257

42699 Solingen

Phone: +49 (0) 212/64568156

Mobile Phone: 0174/2193743

E-Mail: karl.kleemann@emeatec.com

Web: www.emeatec.com

NRW Rheinland

Hipp-Industrievertretungs-GmbH

Am Galgenacker 11

79232 March-Buchheim

Phone: +49 (0) 761 402425

Fax: +49 (0) 761 408351

GSM: +49 (0) 172 7648217

E-Mail: info@hipp-gmbh-fr.de

Baden-Württemberg/Pfalz/Region Rhein-Neckar

Bernd Schneiderheinze

Elektro-Vertretungen

Mühlsteig 20

90579 Langenzenn

Phone: +49 (0) 9101 904810

Fax: +49 (0) 9101 904825

E-Mail: elektro@schneiderheinze.de

Nordbayern

Wolfgang Humig

Handelsvertretung

Rossinstr. 37 b

85057 Ingolstadt

Phone: +49 (0) 841 / 99 32 764

Fax: +49 (0) 841 / 99 32 765

E-Mail: w.humig@humig.de

Südbayern

Bernd Oedekoven GmbH

Werkstattvertretungen

Rudolf-Diesel-Straße 11

56220 Urmitz (Gewerbegebiet)

Phone: +49 (0) 2630/9635-0

Fax: +49 (0) 2630/963535

E-Mail: info@oedekovengmbh.de

Rheinland-Pfalz/Saarland

Schaum Industrievertretung GmbH

Rheinstraße 8

35625 Hüttenberg

Phone: 06403/9119-0

Fax: 06403/9119-20

info@schaum-net.de

Hessen

Commercial sales staff, Austria

Ing. Reinhold Wolfsgruber

M. Schurrer & Co. GmbH
Bayernstraße 39
A-5071 Wals-Siezenheim
Phone: 0664/43 14 4 31 | 0662/85 47 00-11
E-Mail: reinhold.wolfsgruber@schurrer.at

Sales management Austria

Andrä Eberharter

Pipelife Austria GmbH & Co. KG
Bert-Köllensperger-Straße 8a
6065 Thaur/Gewerbegebiet
Phone: 0664/122 65 24
E-Mail: andrae.eberharter@pipelife.at

Vorarlberg, Tirol

Klaus Gutenbrunner

M. Schurrer & Co. GmbH
Bayernstraße 39
A-5071 Wals-Siezenheim
Phone: 0664/444 95 49
E-Mail: klaus.gutenbrunner@schurrer.at

Oberösterreich, Salzburg

Roman Zimmermann

M. Schurrer & Co. GmbH
Franz-Bilko-Gasse 7F
2352 Gumpoldskirchen
Phone: 0664/260 78 78
E-Mail: roman.zimmermann@schurrer.at

Buğenland, Kärnten, Niederösterreich, Wien, Steiermark

Commercial sales staff, Spain

HAUPA Iberica Central

Phone: +34 93-63-82-111
Fax: +34 93-66-21-686
E-Mail: comercial@haupa.es

Rubén Mestanza Portales

Phone: +34 93-63-82-111
Fax: +34 93-66-21-686
E-Mail: ruben.mestanza@haupa.com
Zona: **Segovia, Avila, Soria y Teruel**

Red Levante

E-Mail: redlevante@redlevante.com
José Vicente Antón
Móvil: 667-50-71-47
E-Mail: josevicente@redlevante.com

Fermin Ortega

Móvil: 667-46-56-72
E-Mail: fermin@redlevante.com
Zona: **Alicante, Albacete, Cuenca y Murcia**

Juan Campos Rangel

Mobil: 609-44-77-09
E-Mail: jcguati@hotmail.com
Zona: **Extremadura, Ciudad Real, Toledo**

Albert Pérez Gaona

Móvil: 600-52-05-02
E-Mail: albert7perez@telefonica.net
Zona: **Cataluña**

Granarep (Teodoro Jerez)

Móvil: 600-51-24-94
E-Mail: granarep@granarep.com
Zona: **Granada y Almería**

Marco Antonio Lorca Gonzalez

Móvil: 679-08-31-81
E-Mail: marcoantoniolorca@gmail.com
Zona: **Jaén**

Rafael Martinez Sanz

Móvil: 619-30-32-25
E-Mail: comarsanz@gmail.com
Zona: **Córdoba**

Angel Lopez Garcia

Móvil: 647-52-53-23
E-Mail: angellopezrepresenta@gmail.com
Zona: **Madrid y Guadalajara**

Jose Mª González

Móvil: 610-71-01-00
E-Mail: jmaria.chiqui@gmail.com
Zona: **Málaga**

Antonio Duran (MELEC)

Móvil: 640-15-09-23
E-Mail: comercial@melecl.com
Zona: **Galicia**

Juan Luís Gomez Andana

Móvil: 670-22-74-88
E-Mail: gomezandana@vodafone.es
Zona: **Sevilla, Huelva y Cádiz**

Antonella Garcia

Móvil: 615-010-500
E-Mail: cromwellantonella@gmail.com
Zona: **Castellón, Valencia, Islas Baleares**

Ignacio Menaya

Móvil: 656-19-46-21
E-Mail: ignaciomenaya@coacaragon.com
Zona: **Aragón y La Rioja**

Carmelo Serrano

Móvil: 610-46-50-26
E-Mail: carmeloserrano@cselectrica.com

Rubén Serrano

Móvil: 678-641-391
E-Mail: ruben.serrano@cselectrica.com
Zona: **Pais Vasco, Asturias, Leon, Zamora, Salamanca, Cantabria, Palencia, Valladolid, Burgos, Alava y Navarra**

Julio Perez

Móvil: 696-94-22-26
Fijo: 928-29-08-53
E-Mail: jpf_esc@electrosoncanarias.e.telefonica.net
Zona: **Islas Canarias**

Commercial sales staff, Poland

Andrzej Ryznar

55-100 Trzebnica
ul. Norwida 11
Phone: +48 71 387 48 13
Fax: +48 71 387 48 14
Tel. kom.: +48 603-768-200
E-Mail: ryznar@haupa.pl

Marek Dąbek

55-100 Trzebnica
ul. Norwida 11
Phone: +48 71 387 48 13
Fax: +48 71 387 48 14
Tel. kom.: +48 693-431-542
E-Mail: dabek@haupa.pl

Jakub Bałaziński

55-100 Trzebnica
ul. Norwida 11
Phone: +48 71 387 48 13
Fax: +48 71 387 48 14
Tel. kom.: +48 603-719-731
E-Mail: balazinski@haupa.pl

Marcin Piastun

55-100 Trzebnica
ul. Norwida 11
Phone: +48 71 3874813
Fax.: +48 71 3874814
Tel. kom.: +48 731347196
E-Mail: piastun@haupa.pl



Argentina

REDELEC Argentina S.A.
San Vladimiro 3056
B1642 San Isidro, Pcia de Buenos Aires
Phone: +54 11 4735-6050
E-Mail: info@redelec.com.ar
www.redelec.com.ar



Belgium

S.A. HUPPERTZ N.V.
Terbekehofdreef 51
B 2610 Wilrijk
Phone: 02/334 34 34
Fax: 02/334 34 40
E-Mail: info@huppertz.be



Bosnia

HAUPA S.E.E. d.o.o.
Miroslava Krleze 24
71000 Sarajevo
Phone/Fax: +387(0)33545725
GSM: +38763891678
E-Mail: goran.hrgovic@haupa.com



Bulgaria

Direct support by HAUPA Main Office/
Export Dept. Mr. Marc Wolter
Phone: +49 2191 8418-0
Fax: +49 2191 8418-840
E-Mail: marc.wolter@haupa.com
www.haupa.com



Chile

Santander Import Chile S.P.A.
Exequiel Fernández 4592
Macul, Región Metropolitana, Chile
Phone: +56 2 2454 8062
E-Mail: oluenga@santanderimport.cl



Denmark

Direct support by HAUPA Main Office/
Export Dept. Mr. Dirk Obermann
Phone: +49 2191 8418-0
Fax: +49 2191 8418-840
E-Mail: dirk.obermann@haupa.com
www.haupa.com



Estonia

UAB HAUPA Baltics
Žirmūnų g. 139 - 318
09120 Vilnius
GSM: +370 699 633 63
E-Mail: andrius.krisiunas@haupa.com
www.haupa.com



Finland

UAB HAUPA Baltics
Žirmūnų g. 139 - 318
09120 Vilnius
GSM: +358-46-5231335
E-Mail: andrius.krisiunas@haupa.com
www.haupa.com



France

Direct support by HAUPA Main Office/
Export Dept. Mr. Dirk Obermann
Phone: +49 2191 8418-0
Fax: +49 2191 8418-840
E-Mail: dirk.obermann@haupa.com
www.haupa.com



Greece

Technomat S.A.
Industrial Area of Sindos
57022 Thessaloniki
Phone: +30 2310 777000
Fax: +30 2310 797998
E-Mail: technomat@technomat.gr
www.technomat.gr



Großbritannien

CEE Norm U.K. LTD
Unit 2, Highbridge Court, Stafford Park
Telford, Shropshire TF3 3BD
Phone: +44 1952 212 700
Fax: +44 1952 212 711
E-Mail: sales@ceenorm.co.uk



India

Electro Crimp Contacts (I) Pvt. Ltd.
44/17/1, M.I.D.C. Satpur
422007 Nasik, Maharashtra
Phone: 0091 0253 2350838
Fax: 0091 0253 2354948
Mobil: 9850888866
E-Mail: harshad@eccipl.com
www.eccipl.com



Ireland

MCC Controls Ltd.
Robinhood Business Park
Robinhood Road, Dublin 22
Phone: +353 14506450
Fax: +353 14506104
E-Mail: nfo@mcc-controls.com



Iceland

Smith & Norland
Nóatúni 4
IS-105 Reykjavik
Phone: 00354 520 3000
Fax: 00354 520 3011
E-Mail: hallan@sminor.is



Israel

ER-CO LTD-Management
Tzela Ha-Har-7
IL 7178558 Modi'in
Phone: 00972 732020000
Fax: 00972 732020001
E-Mail: info@erco.co.il / www.erco.co.il



Italy

Direct support by HAUPA Main Office/
Export Dept. Mrs. Kerstin Uebbert
Phone: +49 2191 8418-0
Fax: +49 2191 8418-880
E-Mail: kerstin.uebbert@haupa.com
www.haupa.com



Kosovo

AURORA SHPK
Magjistralia Prishtinë Shkup km 4
10000 Prishtinë
Phone: +377 38 606 123
Fax: +377 44 869 727
E-Mail: info@aurora-kos.com



Croatia

HAUPA S.E.E. d.o.o.
Miroslava Krleze 24
71000 Sarajevo
Phone/Fax: +387(0)33545725
GSM: +38763891678
E-Mail: goran.hrgovic@haupa.com



Latvia

UAB HAUPA Baltics
Žirmūnų g. 139 - 318
09120 Vilnius
GSM: +370 699 633 63
E-Mail: andrius.krisiunas@haupa.com
www.haupa.com



Lithuania

UAB HAUPA Baltics
Žirmūnų g. 139 - 318
09120 Vilnius
GSM: +370 699 633 63
E-Mail: andrius.krisiunas@haupa.com
www.haupa.com



Luxembourg

MINUSINES S.A.
8, rue François Hogenberg
L-1735 Luxembourg
Phone: +352 49 58 58 1
Fax: +352 49 58 66
E-Mail: minlu@pt.lu



Malta

VCT Ltd.
Ponsombly Street
Mosta, MST 4032
Phone: +356 2143 2571
Fax: +356 2143 6186
E-Mail: info@vct.com.mt



Macedonia

HAUPA S.E.E. d.o.o.
Miroslava Krleze 24
71000 Sarajevo
Phone/Fax: +387(0)33545725
GSM: +38763891678
E-Mail: goran.hrgovic@haupa.com



Mexico

KloeMeCom, S.A. de C.V.
Carretera a San Bernardino Chalchihuapan #7-A
San Pablo Ahuatempan, Santa Isabel, Cholula
Puebla. C.P.74355, Mexico
Tel.: 0052 222 2832345
Fax: 0052 222 2832348
E-Mail: Idominguez@ekommexico.com
www.kloeme.com



New Zealand

TransNet NZ Ltd
78 Cryers Road, East Tamaki
Auckland 2013
Phone: +64 9 274 3340
Fax: +64 9 274 5490
E-Mail: sales@transnet.co.nz



Netherlands

Richard Woestenenk
Telefoon: +31 612885793 (GSM)
E-Mail: richard.woestenenk@haupa.com
www.haupa.com



Norway

VIX AS
Stabburveien 24
1617 Fredrikstad
Tel.: +47 92 43 12 00
E-Mail: post@vix.no



Austria

HAUPA Werkzeuge Hans-Udo Paas
Bayernstraße 39
A-5071 Wals-Siezenheim
Phone: +0662 85 47 17
Fax: +0662 85 46 32
E-Mail: austria@haupa.com



Poland

HAUPA Polska Sp. z o.o.
ul. Norwida 11
55100 Trzebnica
Phone: +48 (0)71 387 48 13
Fax: +48 (0)71 387 48 14
E-Mail: haupa@haupa.pl



Portugal

SIGNIVOLTAGE
Rua Poeta Bocage, 2 - 3ºH,
1600-233 LISBOA,
Tel. +351 218 160 240
E-mail: alberto.cardoso@haupa.com



Romania

SC HAUPA SRL
331059 Hunedoara
Bulevard 1848, Nr. 13, Ap. 6
GSM: +4 0744 561 567
Fax: +4 0354 407 994
E-Mail: mihai.lupu@haupa.com



Russia

HAUPA-RU Ltd
ul. Industrialnaya 9/1
180021 Pskov, RUSSIA
Phone: +7 (495) 133-62-24
E-Mail: russia@haupa.com
www.haupa-ru.ru



Sweden

Direct support by HAUPA Main Office/
Export Dept. Mr. Dirk Obermann
Phone: +49 2191 8418-0
Fax: +49 2191 8418-840
E-Mail: dirk.obermann@haupa.com



Switzerland

AXTRON GmbH
Hungerbuelstr. 22
CH-8500 Frauenfeld
Phone: 0041 / 527 21 58 58
Fax: 0041 / 527 21 58 59
E-Mail: info@axtron.ch



Serbia

ICON by HAUPA d.o.o.
Miše Dimitrijevića 44
21000 Novi Sad
GSM: +381 21 300-2937
E-Mail: info@iconbyhaupa.rs
www.iconbyhaupa.rs



Slovakia

Direct support by HAUPA Main Office/
Export Dept. Mr. Dirk Obermann
Phone: +49 2191 8418-0
Fax: +49 2191 8418-840
E-Mail: dirk.obermann@haupa.com



Slovenia

HAUPA S.E.E. d.o.o.
Miroslava Krleže 24
71000 Sarajevo
Phone/Fax: +387(0)33545725
GSM: +38763891678
E-Mail: goran.hrgovic@haupa.com



Spain

HAUPA Ibérica S. L.
c/. Muralla de Sant Llorenç, 37 2^oA
08302 Mataró
Phone: +34 93-63-82-111
Fax: +34 93-66-21-686
E-Mail: comercial@haupa.es



South Africa

Surge Technology (Pty) Ltd.
18-20 Arbeid Avenue, Strydom Park
Randburg 2125
Phone: +27 (0) 11 792-1303/4/5
Fax: +27 (0) 11 793-6928
E-Mail: info@surgetec.co.zam



Czechia

ELIMA ELEKTRO s.r.o.
Hradecká 506
506 01 Jičín
Phone: +420 493 524 390
Fax: +420 493 525 720
E-Mail: objednavky@elima.cz



Taiwan

Power Forward co., ltd
No.8, Ln.32, Guilin St., Qianzhen District
806 Kaohsiung City
Phone: +38 75362767
E-Mail: powerforward.mail@gmail.com



Ukraine

TEKO INTERFACE TOB
ul. Lomonosova, 73 g
03189 Kiev
Phone: +38 044 374-06 -40
Fax: +38 044 374-06- 42
E-Mail: info@tekointerface.com.ua
tekointerface.com.ua



Ukraine

Scientific-Produktion Firm, ElectroDinamika
Isaevskaya Str. 5
61033 Kharkov
GSM: +38 (057) 704-15-41
Fax: +38 (057) 715-79-98
E-Mail: office@electrodinamika.com
www.electrodinamika.com.ua



Hungary

POLY-NORM 2000 Kft.
Lócsei út 81.
1147 Budapest
Phone: +361/461-0170
Fax: +361/321-1618
E-Mail: haupa@polynorm2000.hu



Belarus

UAB HAUPA Baltics
Žirmūnų g. 139 - 318
09120 Vilnius
GSM: +375 44 4108113
E-Mail: andrius.krisiunas@haupa.com



Central America

INTEK
Guatemala, El Salvador, Honduras,
Nicaragua, Costa Rica
www.intek-ca.com



Cyprus

Direct support by HAUPA Main Office/
Export Dept. Mr. Dirk Obermann
Phone: +49 2191 8418-0
Fax: +49 2191 8418-840
E-Mail: dirk.obermann@haupa.com



Point of sales

HAUPA Shop in Shop Sales System

A well-stocked display of tools at the point of sale is the hallmark of every good electrical wholesaler and offers customers the full service they need.

Within this complete customer-focussed presentation concept, your clients will find a wide range of HAUPA quality tools and the materials to go with them. It includes tools from the „Around the cable“, „Working under tension“ and „Standard program“ ranges and offers the user a very high degree of flexibility.

Werkzeuge & Kabelverbindungen



Cupboards with lockable glass door. Perforated panel displays also available in 1,00m and 1,25 m width. Dimensions: 2,20 m x 1,25 m x 40 cm. (The entire list of items available for display on the panels can be viewed on the internet or by mailing sales@haupa.com).

HAUPA Sales promotion

On request, HAUPA also naturally supplies individual cabinets and wall displays fitted out with your own choice of tools.

Our different resenatation models offer possibilities for your sales area which are both interesting and variable.

HAUPA stands for hand tools of the highest quality and safety for the electrical engineer. With our products, we always pay attention to the HAUPAplus; the special advantage for our customers. Our passion is to build a good, reliable and safe tool, which the user will enjoy for a long time.

Tradition and innovative prowess for more than 60 years

Hans-Udo Paas founded HAUPA in 1961 in Remscheid, the heart of the tool industry. Over the nearly 60-year history of the company, our medium-sized, value-oriented family business has developed into a globally active company. The recipe for success and our stable growth is the combination of tradition, experience, expertise and innovation. It is our constant endeavour to develop products of the highest precision, which offer the electrical engineer added value



QUALITY and SAFETY are hugely important to us!

Our product portfolio includes high-quality system tools and certified cable connection technology for the electrical trade and the electrical industry. In addition, we produce and market a wide range of basic tools for professional use in electrical engineering. The high quality of the products is the top priority at HAUPA. To ensure this, we constantly carry out quality checks in-house.

In recent years, our range has been expanded many times over. In order to be able to serve and satisfy our customers beyond electrical engineering, we are always busy adding new tools and accessories to our portfolio. This allows us to provide a central point of contact in the most diverse fields of the electrical trade.

Logistics and shipping

Thanks to our modern warehouse in Remscheid, we always have a large proportion of our products in stock. Our experienced logistics team strives to ensure that our goods usually make their way to the customer on the day of the order. Customer satisfaction, your trust and on-time delivery are our most important goals!



Competent contact person

We personally take care of the questions and problems of our customers. When you get in touch with us, you can be sure that we will help you. Our on-site employees are professionals in the field, and some have worked as electrical engineers themselves, making them the perfect contact person for you.

If you are not sure which materials you can process with which tool, we would be delighted to help - and answer all other questions, too!



haupa.com



brinko.de



HAUPA.RS



BRINKO.RS



haupa_official



brinko_gmbh



HAUPAdemo



BRINKO GmbH



HAUPA GmbH & Co. KG



BRINKO[®]
powered by **haupa**[®]

Germany
HAUPA GmbH & Co. KG
Königstraße 165-169
42853 Remscheid
Phone: +49 (0)2191 84 18-0
Fax: +49 (0)2191 84 18 840
E-Mail: sales@haupa.com
www.haupa.com

HAUPA WI22134 – 1600/EN



haupa[®]
...convincing solutions